

15kHz, 670nA, Rail-to-Rail I/O CMOS Operational Amplifier

FEATURES

- **GAIN BANDWIDTH:**15kHz
- **RAIL-TO-RAIL INPUT AND OUTPUT**
0.5mV Typical Vos
- **INPUT VOLTAGE RANGE:** -0.1V to +5.6V
with Vs = 5.5V
- **SUPPLY RANGE:** +1.4V to +5.5V
- **SPECIFIED UP TO +125°C**
- **Micro SIZE PACKAGES:** SOT23-5

APPLICATIONS

- **SENSORS**
- **PHOTODIODE AMPLIFICATION**
- **WEARABLE PRODUCTS**
- **TEMPERATURE MEASUREMENT**
- **BATTERY POWERED SYSTEM**

DESCRIPTION

The RS8031, RS8032, RS8034, families of products offer low voltage operation and rail-to-rail input and output, as well as excellent speed/power consumption ratio, providing an excellent bandwidth (15kHz) and slew rate of 7.5V/ms. The op-amps are unity gain stable and feature an ultra-low input bias current.

The devices are ideal for sensor interfaces, active filters and portable applications. The RS8031, RS8032, RS8034 families of operational amplifiers are specified at the full temperature range of -40°C to +125°C under single or dual power supplies of 1.4V to 5.5V.

PIN CONFIGURATIONS

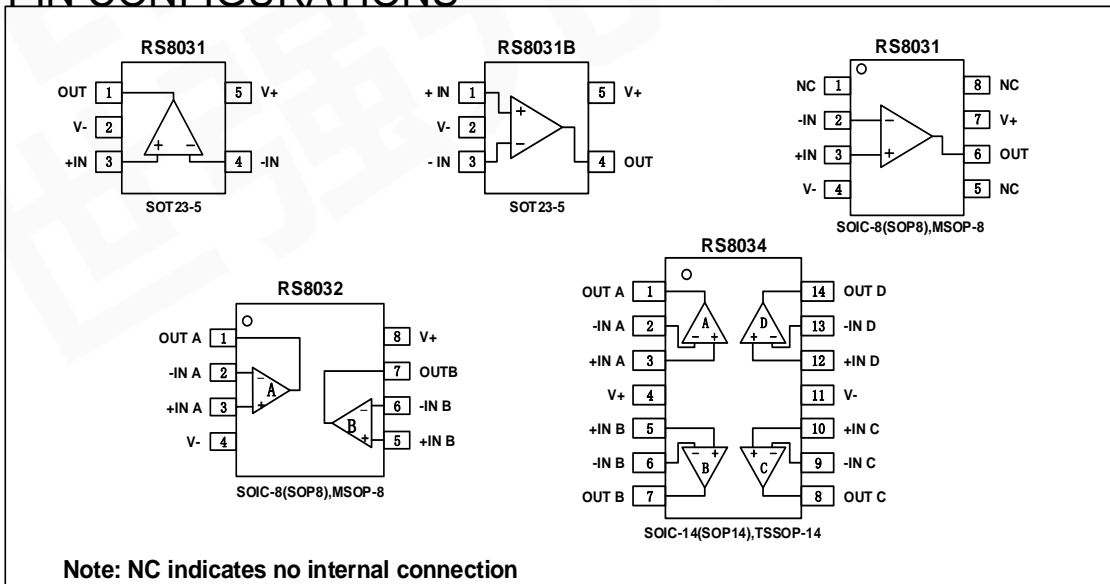

ABSOLUTE MAXIMUM RATINGS ⁽¹⁾

| | |
|---|----------------------|
| Supply Voltage, V+ to V-..... | 7.0V |
| Input Terminals, Voltage ⁽²⁾ | - 0.5 to (V+) + 0.5V |
| Current ⁽²⁾ | ±10mA |
| Storage Temperature | -65°C to +150°C |
| Operating Temperature | -40°C to +125°C |
| Junction Temperature..... | 150°C |
| Package Thermal Resistance @ T _A = +25°C | |
| SOT23-5, SOT23-6..... | 200°C/W |
| MSOP-10, SOIC-8 | 150°C/W |
| SOIC-14, TSSOP-14..... | 100°C/W |
| Lead Temperature (Soldering, 10s) | 260°C |
| ESD Susceptibility | |
| HBM | 5000V |
| MM | 400V |

ESD SENSITIVITY CAUTION

ESD damage can range from subtle performance degradation to complete device failure. Precision integrated circuits may be more susceptible to damage because very small parametric changes could cause the device not to meet its published specifications.

- (1) Stresses above these ratings may cause permanent damage. Exposure to absolute maximum conditions for extended periods may degrade device reliability. These are stress ratings only, and functional operation of the device at these or any other conditions beyond those specified is not implied.
- (2) Input terminals are diode-clamped to the power-supply rails. Input signals that can swing more than 0.5V beyond the supply rails should be current-limited to 10mA or less.

PACKAGE/ORDERING INFORMATION

| PRODUCT | ORDERING NUMBER | TEMPERATURE RANGE | PACKAGE LEAD | PACKAGE MARKING | PACKAGE OPTION |
|---------|-----------------|-------------------|----------------|-----------------|--------------------|
| RS8031 | RS8031XK | -40°C~125°C | SOIC-8(SOP8) | RS8031 | Tape and Reel,2500 |
| | RS8031XF | -40°C~125°C | SOT23-5 | 8031 | Tape and Reel,3000 |
| | RS8031BXF | -40°C~125°C | SOT23-5 | 8031B | Tape and Reel,3000 |
| | RS8031XM | -40°C~125°C | MSOP-8 | RS8031 | Tape and Reel,3000 |
| RS8032 | RS8032XK | -40°C~125°C | SOIC-8(SOP8) | RS8032 | Tape and Reel,2500 |
| | RS8032XM | -40°C~125°C | MSOP-8 | RS8032 | Tape and Reel,3000 |
| RS8034 | RS8034XP | -40°C~125°C | SOIC-14(SOP14) | RS8034 | Tape and Reel,2500 |
| | RS8034XQ | -40°C~125°C | TSSOP-14 | RS8034 | Tape and Reel,3000 |

ELECTRICAL CHARACTERISTICS

 (At $T_A = +25^\circ\text{C}$, $V_S = 5.0\text{V}$, $R_L = 1\text{M}\Omega$ connected to $V_S/2$, and $V_{OUT} = V_S/2$, unless otherwise noted.)

| PARAMETER | | CONDITIONS | RS8031,RS8032,RS8034 | | | UNITS |
|---------------------------|------------------------------|--|----------------------|-----|------|------------------------------|
| | | | MIN | TYP | MAX | |
| POWER SUPPLY | | | | | | |
| V_S | Operating Voltage Range | | 1.4 | | 5.5 | V |
| I_Q | Quiescent Current/Amplifier | | | 670 | 1500 | nA |
| PSRR | Power-Supply Rejection Ratio | $V_S = 2.5\text{V to } 5.5\text{V}$, $V_{cm} = (V_-) + 0.5\text{V}$ | 62 | 70 | | dB |
| INPUT | | | | | | |
| V_{os} | Input Offset Voltage | $V_{cm} = V_S/2$ | | 0.5 | 3 | mV |
| $\Delta V_{os}/\Delta T$ | Input Offset Voltage Drift | $V_{cm} = V_S/2$, $-40^\circ\text{C} \leq T_A \leq 125^\circ\text{C}$ | | 2.3 | | $\mu\text{V}/^\circ\text{C}$ |
| I_B | Input Bias Current | | | 1 | 10 | pA |
| I_{os} | Input Offset Current | | | 1 | 10 | pA |
| V_{cm} | Common-Mode Voltage Range | $V_S = 5.5\text{V}$ | -0.1 | | 5.6 | V |
| CMRR | Common-Mode Rejection Ratio | $V_S = 5.5\text{V}$, $V_{cm} = -0.1\text{V to } 4\text{V}$ | 73 | 90 | | dB |
| | | $V_S = 5.5\text{V}$, $V_{cm} = -0.1\text{V to } 5.6\text{V}$ | 60 | 83 | | dB |
| OUTPUT | | | | | | |
| AOL | Open-Loop Voltage Gain | $V_S = 1.4\text{V}$, $R_L = 50\text{k}\Omega$, $V_o = V_S - 0.1\text{V}$ | 85 | 102 | | dB |
| | | $V_S = 5.0\text{V}$, $R_L = 50\text{k}\Omega$, $V_o = V_S - 0.1\text{V}$ | 92 | 106 | | dB |
| | Output Swing From Rail | $R_L = 50\text{k}\Omega$ | | 5 | | mV |
| I_{out} | Output Short-Circuit Current | | | 11 | | mA |
| FREQUENCY RESPONSE | | | | | | |
| SR | Slew Rate | | | 7.5 | | V/ms |
| GBP | Gain-Bandwidth Product | | | 15 | | kHz |
| PM | Phase Margin | | | 60 | | $^\circ$ |
| NOISE | | | | | | |
| $e_{n\text{p-p}}$ | Input Voltage Noise | $f = 0.1\text{ Hz to } 10\text{ Hz}$ | | 2.4 | | μVpp |
| e_n | Input Voltage Noise Density | $f = 1\text{ kHz}$ | | 160 | | $\text{nV}/\sqrt{\text{Hz}}$ |

TYPICAL CHARACTERISTICS

At $T_A = +25^\circ\text{C}$, $V_S = 5\text{V}$, $R_L = 1\text{M}\Omega$ connected to $V_S/2$, $C_L = 60\text{pF}$, $V_{CM} = V_S/2$, unless otherwise noted.

SMALL-SIGNAL STEP RESPONSE

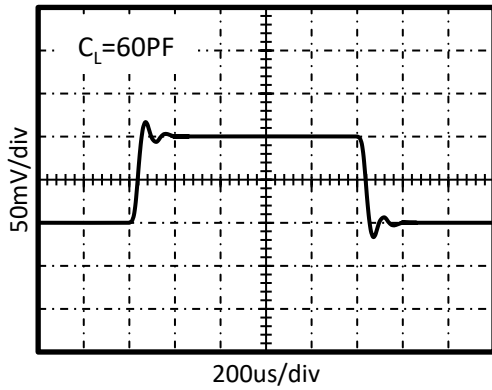

SMALL-SIGNAL STEP RESPONSE

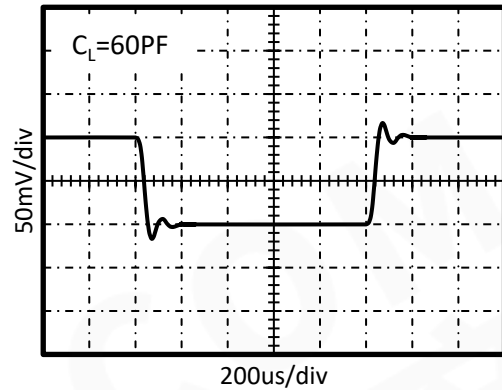

LARGE-SIGNAL STEP RESPONSE

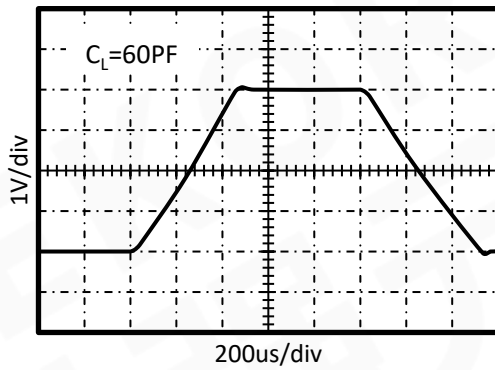

LARGE-SIGNAL STEP RESPONSE

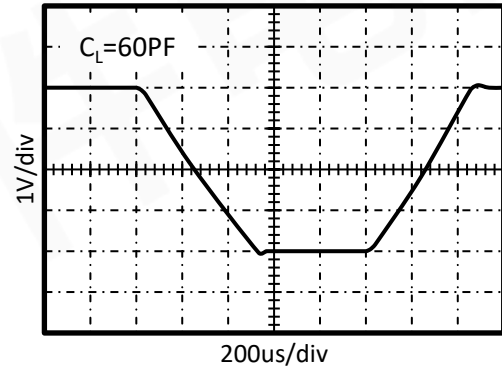

SINK CURRENT vs TEMPERATURE

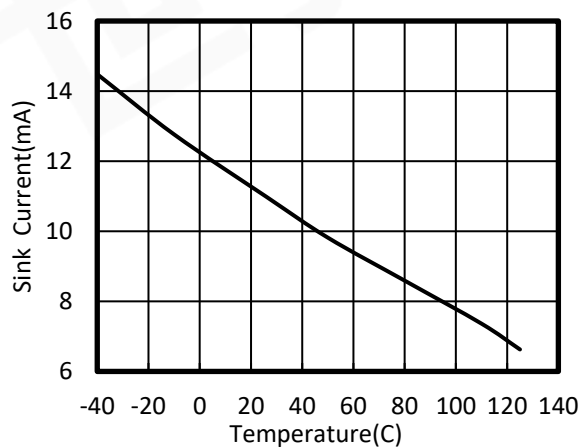

SOURCE CURRENT vs TEMPERATURE

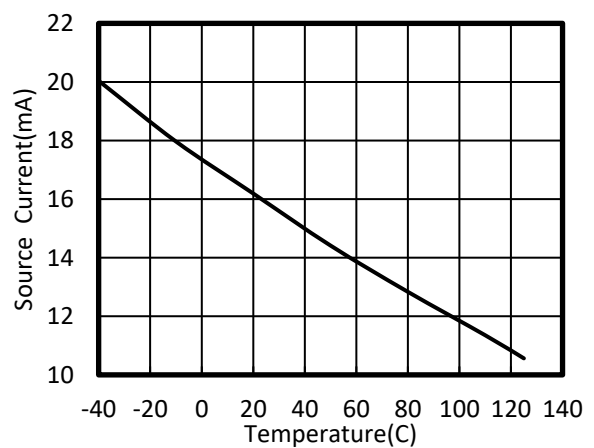

PACKAGE OUTLINE DIMENSIONS

SOT23-5

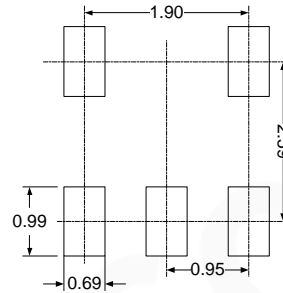
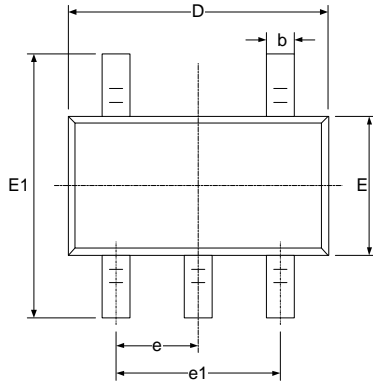
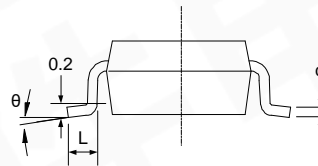
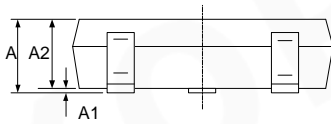

RECOMMENDED LAND PATTERN (Unit: mm)

| Symbol | Dimensions In Millimeters | | Dimensions In Inches | |
|----------|---------------------------|-------|----------------------|-------|
| | Min | Max | Min | Max |
| A | 1.050 | 1.250 | 0.041 | 0.049 |
| A1 | 0.000 | 0.100 | 0.000 | 0.004 |
| A2 | 1.050 | 1.150 | 0.041 | 0.045 |
| b | 0.300 | 0.500 | 0.012 | 0.020 |
| c | 0.100 | 0.200 | 0.004 | 0.008 |
| D | 2.820 | 3.020 | 0.111 | 0.119 |
| E | 1.500 | 1.700 | 0.059 | 0.067 |
| E1 | 2.650 | 2.950 | 0.104 | 0.116 |
| e | 0.950(BSC) | | 0.037(BSC) | |
| e1 | 1.800 | 2.000 | 0.071 | 0.079 |
| L | 0.300 | 0.600 | 0.012 | 0.024 |
| θ | 0° | 8° | 0° | 8° |

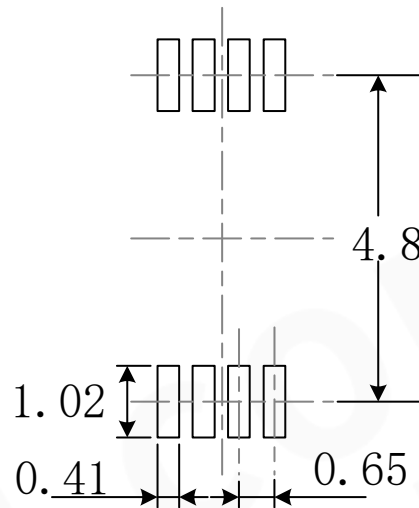
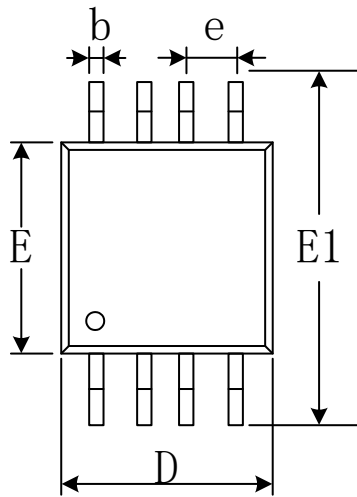
MSOP-8

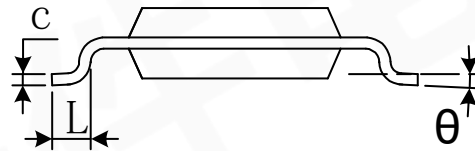
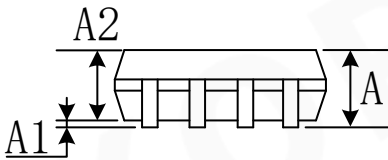

RECOMMENDED LAND PATTERN (Unit: mm)



| Symbol | Dimensions In Millimeters | | Dimensions In Inches | |
|----------|---------------------------|-------|----------------------|-------|
| | Min | Max | Min | Max |
| A | 0.820 | 1.100 | 0.032 | 0.043 |
| A1 | 0.020 | 0.150 | 0.001 | 0.006 |
| A2 | 0.750 | 0.950 | 0.030 | 0.037 |
| b | 0.250 | 0.380 | 0.010 | 0.015 |
| c | 0.090 | 0.230 | 0.004 | 0.009 |
| D | 2.900 | 3.100 | 0.114 | 0.122 |
| e | 0.650(BSC) | | 0.026(BSC) | |
| E | 2.900 | 3.100 | 0.114 | 0.122 |
| E1 | 4.750 | 5.050 | 0.187 | 0.199 |
| L | 0.400 | 0.800 | 0.016 | 0.031 |
| θ | 0° | 6° | 0° | 6° |

TSSOP-14

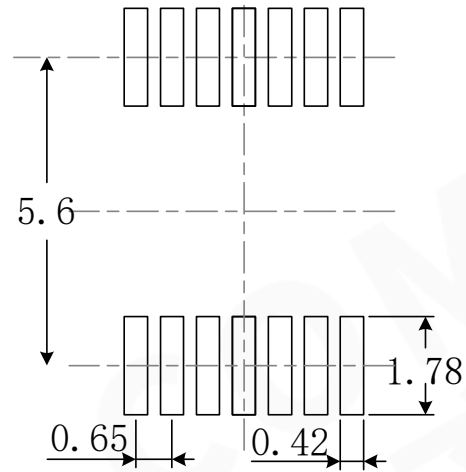
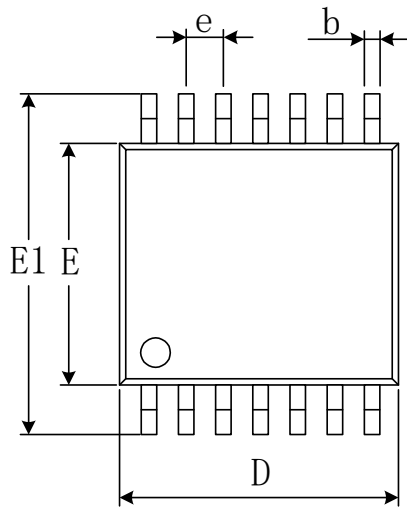

RECOMMENDED LAND PATTERN (Unit: mm)

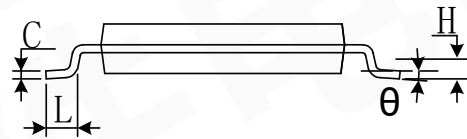
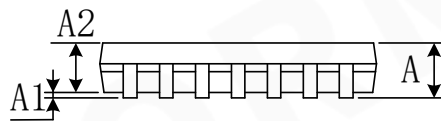

| Symbol | Dimensions In Millimeters | | Dimensions In Inches | |
|----------|---------------------------|-------|----------------------|-------|
| | Min | Max | Min | Max |
| A | | 1.200 | | 0.047 |
| A1 | 0.050 | 0.150 | 0.002 | 0.006 |
| A2 | 0.800 | 1.050 | 0.031 | 0.041 |
| b | 0.190 | 0.300 | 0.007 | 0.012 |
| c | 0.090 | 0.200 | 0.004 | 0.008 |
| D | 4.860 | 5.100 | 0.191 | 0.201 |
| E | 4.300 | 4.500 | 0.169 | 0.177 |
| E1 | 6.250 | 6.550 | 0.246 | 0.258 |
| e | 0.650(BSC) | | 0.026(BSC) | |
| L | 0.500 | 0.700 | 0.020 | 0.028 |
| H | 0.25(TYP) | | 0.01(TYP) | |
| θ | 1° | 7° | 1° | 7° |

SOIC-8(SOP8)

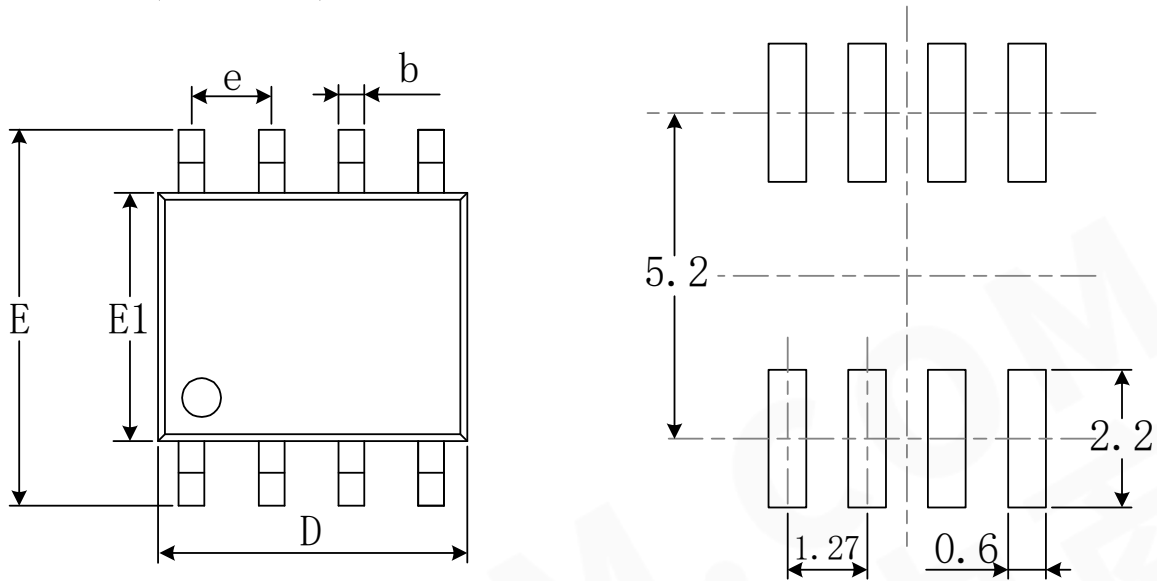

RECOMMENDED LAND PATTERN (Unit: mm)

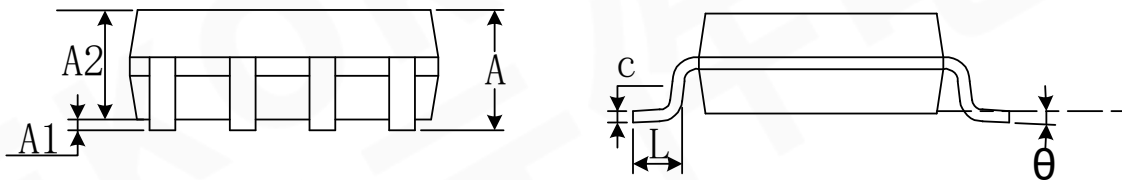

| Symbol | Dimensions In Millimeters | | Dimensions In Inches | |
|----------|---------------------------|-------|----------------------|-------|
| | Min | Max | Min | Max |
| A | 1.350 | 1.750 | 0.053 | 0.069 |
| A1 | 0.100 | 0.250 | 0.004 | 0.010 |
| A2 | 1.350 | 1.550 | 0.053 | 0.061 |
| b | 0.330 | 0.510 | 0.013 | 0.020 |
| c | 0.170 | 0.250 | 0.007 | 0.010 |
| D | 4.800 | 5.000 | 0.189 | 0.197 |
| e | 1.270(BSC) | | 0.050(BSC) | |
| E | 5.800 | 6.200 | 0.228 | 0.244 |
| E1 | 3.800 | 4.000 | 0.150 | 0.157 |
| L | 0.400 | 1.270 | 0.016 | 0.050 |
| θ | 0° | 8° | 0° | 8° |

SOIC-14(SOP14)

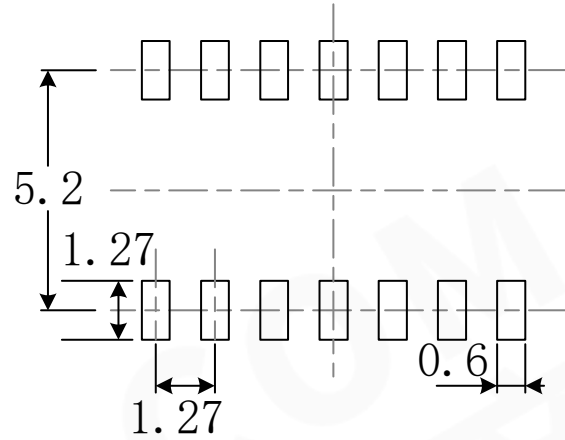
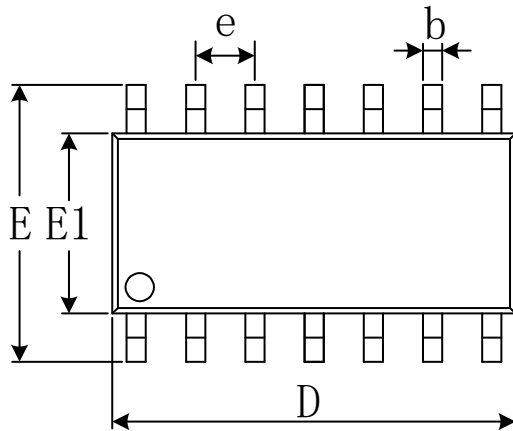

RECOMMENDED LAND PATTERN (Unit: mm)

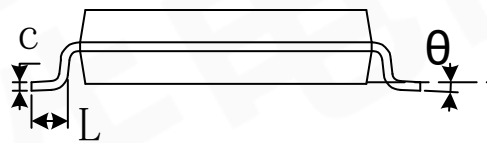
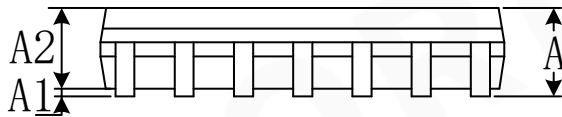

| Symbol | Dimensions In Millimeters | | Dimensions In Inches | |
|----------|---------------------------|-------|----------------------|-------|
| | Min | Max | Min | Max |
| A | 1.350 | 1.750 | 0.053 | 0.069 |
| A1 | 0.100 | 0.250 | 0.004 | 0.010 |
| A2 | 1.350 | 1.550 | 0.053 | 0.061 |
| b | 0.310 | 0.510 | 0.012 | 0.020 |
| c | 0.100 | 0.250 | 0.004 | 0.010 |
| D | 8.450 | 8.850 | 0.333 | 0.348 |
| e | 1.270(BSC) | | 0.050(BSC) | |
| E | 5.800 | 6.200 | 0.228 | 0.244 |
| E1 | 3.800 | 4.000 | 0.150 | 0.157 |
| L | 0.400 | 1.270 | 0.016 | 0.050 |
| θ | 0° | 8° | 0° | 8° |