

PRODUCT NO.	DSWB07LHGFT
RoHS compliant	

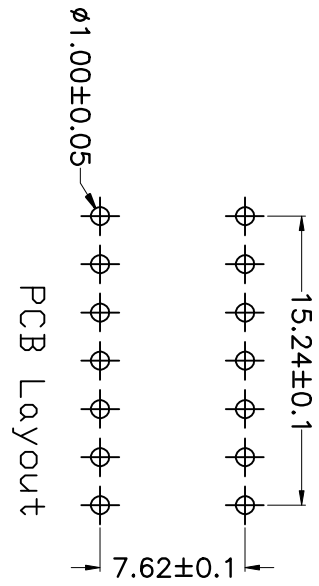

PCB Layout

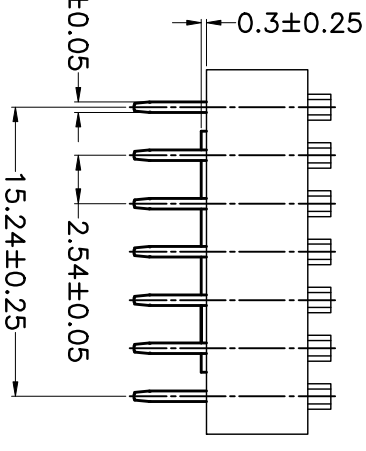
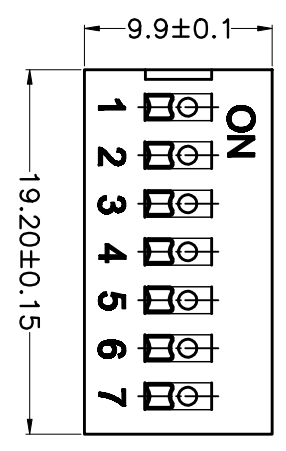
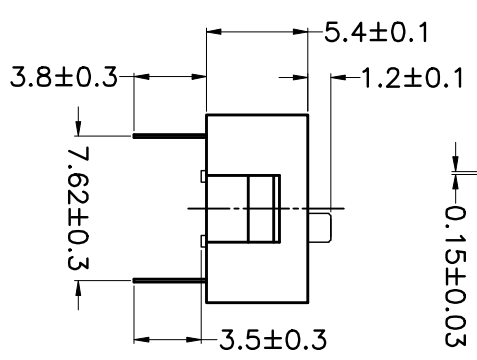
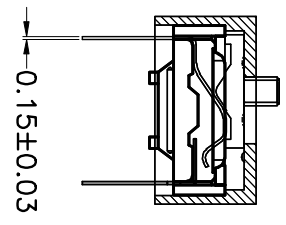
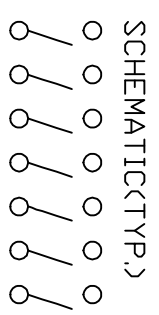

- Note:**
- All dimensions are in millimeters.
 - General tolerance: $\pm 0.2\text{mm}$.
 - Material:

- Base: UL94V-0 PBT Thermoplastic (Black).
- Cover: UL94V-0 PBT Thermoplastic (Black/Red/Blue).
- Actuators: UL94V-0 PA66 Thermoplastic (White).
- Contact plating: Gold plating over nickel.
- Pitting material: Epoxy.

- Electrical
- Electrical: 2000 Operations per switch 24/VDC, 25mA.
- Non-Switching Rating: 100mA, 50/VDC.
- Switching Rating: 25mA, 24/VDC
- Contact Resistance: 100 mΩ Max at initial.

- Mechanical
- Mechanical life: 2000 Operations per switch.
- Stroke: 2.0mm.
- Operation Temp: -20°C to 70°C.
- Storage Temp: -40°C to 85°C.

6. PART NUMBER DESCRIPTION:

DS WB 07 L H G E T

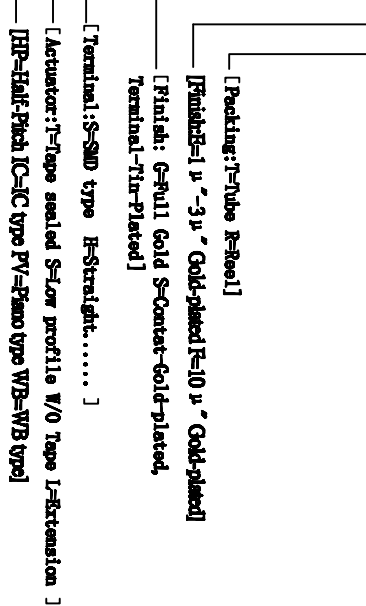

TOLERANCE UNLESS OTHERWISE SPECIFIED		INSPECTION COPY	
LINER	ANGLES	PROJECTION	
0 ± 0.30	0 ± 1°	[Symbol]	
.00 ± 0.20	.0 ± 0.5°		
.000± 0.10	.00±		
DESIGN	LU ER XIN	2013/07/02	
DRAWING			
CHECK			
APPRO.			
FILE NO.	DSWB07LHGFT-A		
SIZE	A4		
UNIT	mm		
SCALE	1:1		
SHEET	1 OF 1		
REV.	A		

东莞市富实业有限公司
Dongguan Kingtek Industrial Co., Ltd.

BY DSWB SERIES PITCH 2.54mm
PRODUCT FAMILY DSWB SERIES

PRAT NO. DSWB07LHGFT

FILE NO. DSWB07LHGFT-A
SIZE UNIT SCALE SHEET REV.
A4 mm 1:1 1 OF 1 A