

5V, 3.1A, 550KHz High Efficiency Low Ripple Synchronous Step-Up Converter

Description

The FP6717 is a high efficiency, fixed frequency 550KHz, current mode PWM boost DC/DC converter which could operate battery such as input voltage down to 2.5V. The converter output voltage can be adjusted to a maximum of 5.25V by an external resistor divider. Besides the converter includes a 39mΩ N-channel MOSFET switch and 42mΩ P-channel synchronous rectifier. So no external Schottky diode is required and could get better efficiency near 90%.

The converter is based on a fixed frequency, current mode, pulse-width-modulation PWM controller that goes automatically into PSM mode at light load.

When converter operation into discontinuous mode, the internal anti-ringing switch will reduce interference and radiated electromagnetic energy.

The FP6717 is available in a space-saving SOP-8 (Exposed Pad) package for portable application.

Pin Assignments

SP Package (SOP-8 Exposed Pad)

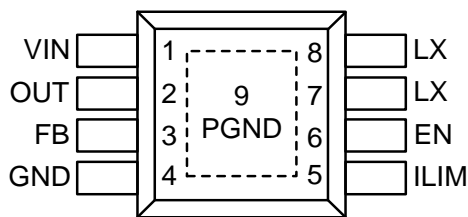

Figure 1. Pin Assignment of FP6717

Features

- High Efficiency up to 90%
- Low $R_{DS(ON)}$ Integrated Power MOSFET
- NMOS 39mΩ/PMOS 42mΩ
- Wide Input Voltage Range: 2.5V to 5.25V
- Fixed 550KHz Switching Frequency
- Low-Power Mode for Light Load Conditions
- $\pm 2.0\%$ Voltage Reference Accuracy
- Adjustable Current Limit
- PMOS Current Limit for Short Circuit Protection
- Low Quiescent Current
- Input Under Voltage Lockout
- Internal Compensation Function
- Built-In Soft Start Function
- Over-Temperature Protection with Auto Recovery
- Output Overvoltage Protection
- SOP-8 (Exposed Pad) Pb-Free Package

Applications

- Portable Power Bank
- Wireless Equipment
- Handheld Instrument
- GPS Receiver

Ordering Information

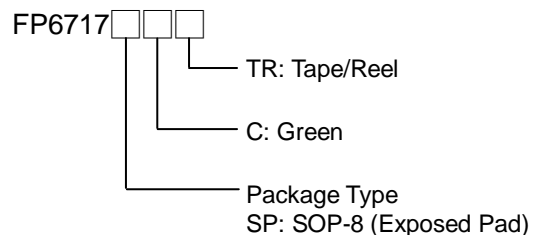

Typical Application Circuit

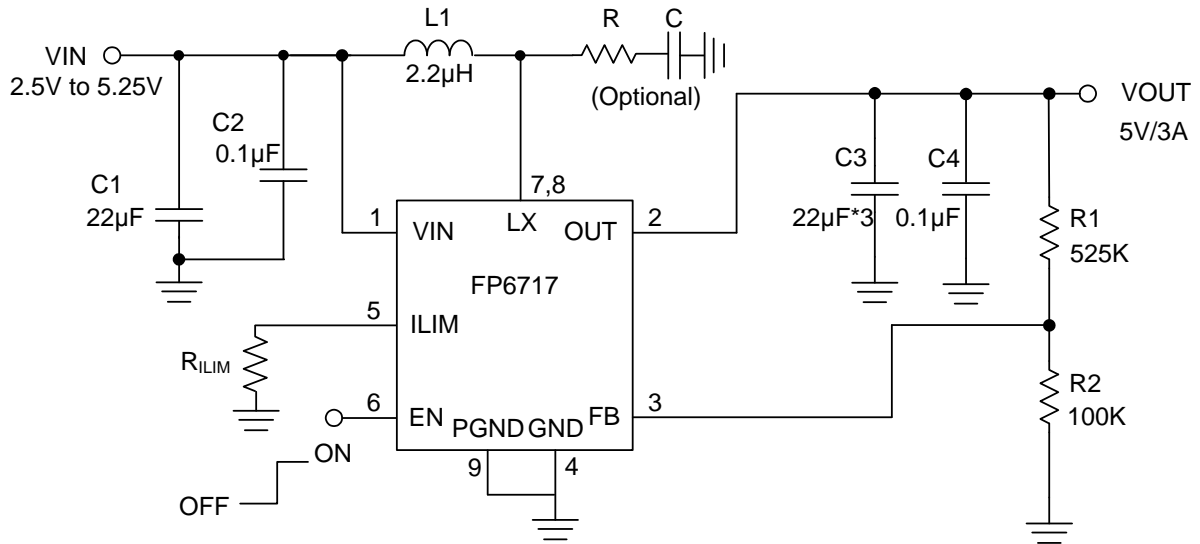
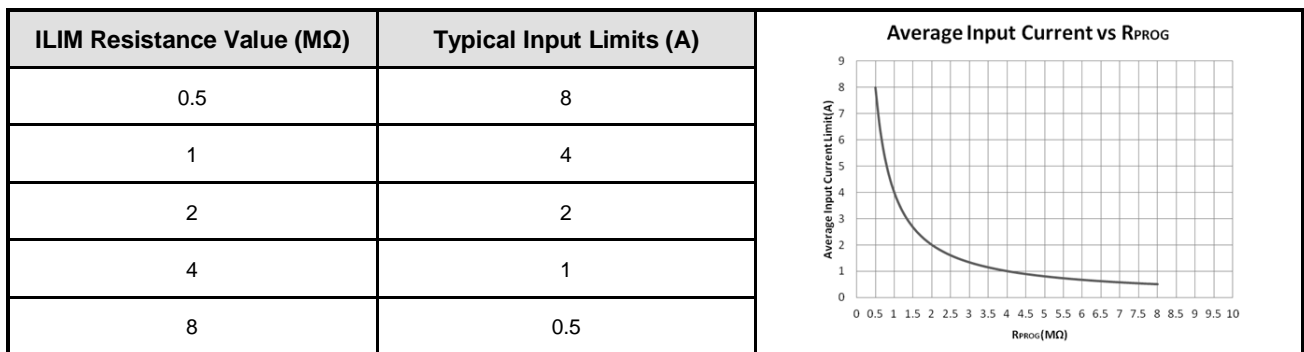

Figure 2. Typical Application Circuit



Functional Pin Description

Pin Name	Pin No.	Pin Function
VIN	1	Power Supply Input Pin.
OUT	2	Output of the Synchronous Rectifier.
FB	3	Voltage Feedback Input Pin.
GND	4	Ground Pin. Connect GND to exposed pad.
ILIM	5	Programming Input for Average Input Current.
EN	6	Logic Controlled Shutdown Input.
LX	7,8	Power Switching Connection. Connect LX to the inductor and output rectifier.
PGND	9	Power Ground Pin.

Block Diagram

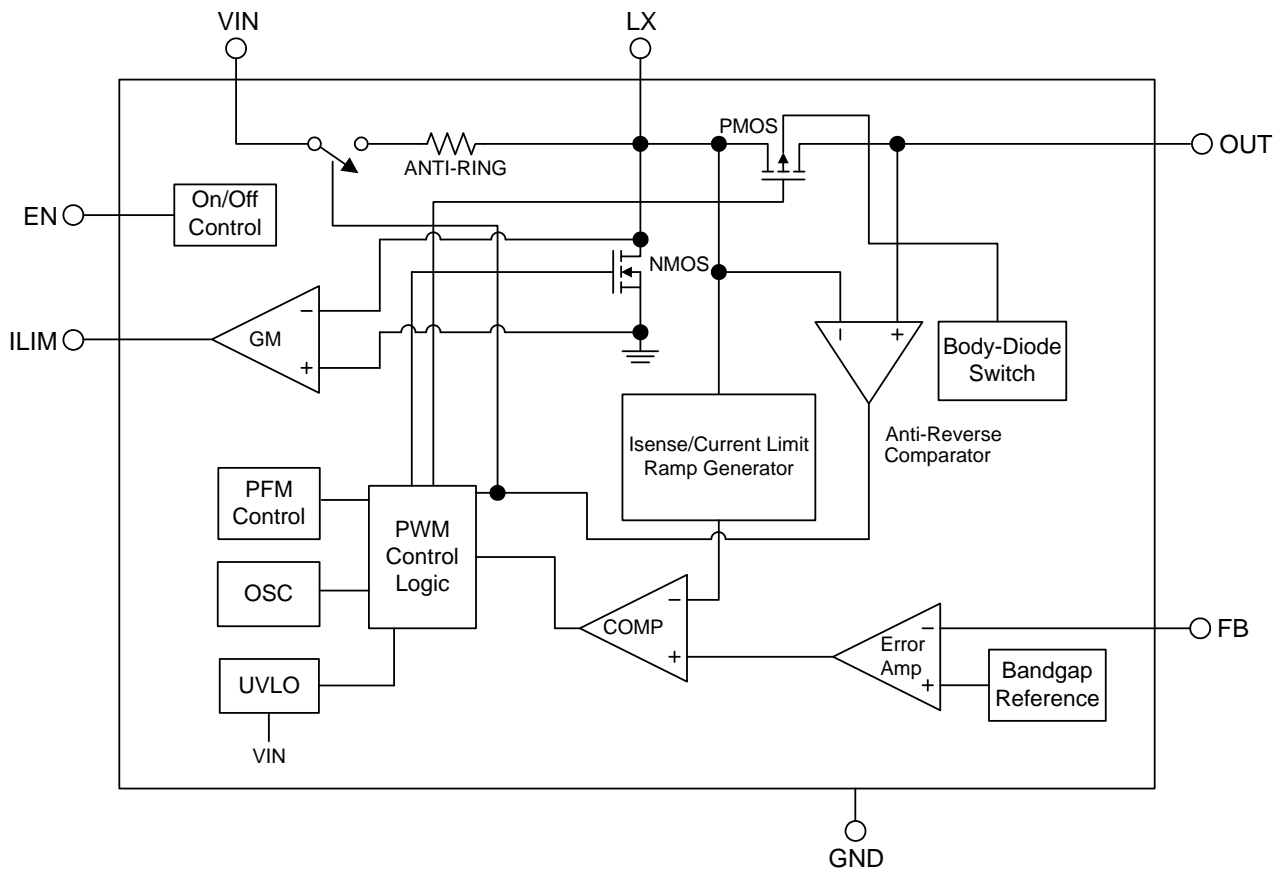

Figure 3. Block Diagram of FP6717

Absolute Maximum Ratings (Note 1)

- Supply Voltage V_{IN} ----- -0.3V to +6V
- LX Voltage V_{LX} ----- -0.3V to +6V
- All Other Pins Voltage ----- -0.3V to +6V
- Maximum Junction Temperature (T_J) ----- +150°C
- Storage Temperature (T_S) ----- -65°C to +150°C
- Lead Temperature (Soldering, 10sec.) ----- +260°C
- Package Thermal Resistance, (θ_{JA})
 - SOP-8 (Exposed Pad) ----- 60°C/W
- Package Thermal Resistance, (θ_{JC})
 - SOP-8 (Exposed Pad) ----- 15°C/W

Note 1 : Stresses beyond this listed under "Absolute Maximum Ratings" may cause permanent damage to the device.

Recommended Operating Conditions

- Supply Voltage V_{IN} ----- +2.5V to +5.25V
- Output Voltage Range ----- up to +5.25V
- Operation Temperature Range ----- -40°C to +85°C

Electrical Characteristics

($V_{IN}=3.3V$, $T_A=25^{\circ}C$, unless otherwise specified.)

Parameter	Symbol	Conditions	Min	Typ	Max	Unit
VIN Input Supply Voltage	V_{IN}		2.5		5.25	V
VIN Supply Current (Switching)		$V_{IN}=3.3V$, $V_{FB}=0.7V$ Measure V_{IN}		300	500	μA
VIN Supply Current (No witching)		$V_{FB}=1V$		45		μA
Feedback Voltage	V_{FB}	$2.5V \leq V_{IN} \leq 5.5V$	0.784	0.8	0.816	V
High-Side PMOSFET $R_{DS(ON)}$				42		m Ω
Low-Side NMOSFET $R_{DS(ON)}$				39		m Ω
High-Side MOSFET Leakage Current	$I_{LX(leak)}$	$V_{LX}=5.5V$, $V_{OUT}=0V$			10	μA
Low-Side MOSFET Leakage Current		$V_{LX}=5.5V$			10	μA
Oscillation Frequency	F_{OSC}		450	550	650	KHz
Short Circuit Trip Point		Monitored FB voltage		0.3		V
Short Circuit Current Limit		$V_{IN}=3.3V$		50		mA
Maximum Duty Cycle	D_{MAX}	$V_{IN}=3.3V$	90			%
ILIM Current		$R_{ILIM}=500K$		8		A
ILIM Current Gain		$V_{IN}=3.3V$		8		M Ω -A/A
Line Regulation		$V_{IN}=2.5V$ to $5.5V$, $I_{OUT}=100mA$			1	%
Load Regulation		$I_{OUT}=0.5A$ to $2A$		0.5		%
Input UVLO Threshold	$V_{UVLO(VTH)}$	V_{IN} Rising		2.3		V
Under Voltage Lockout Threshold Hysteresis	$V_{UVLO(HYS)}$	V_{IN} Falling		250		mV
OVP Threshold Voltage on OUT Pin				5.7		V
OVP Threshold Hysteresis				350		mV
Internal Soft-Start Time				1	3	ms
EN Input Low Voltage	$V_{EN(L)}$				0.4	V
EN Input High Voltage	$V_{EN(H)}$		1.4			V
EN Input Current	I_{EN}	$V_{IN}=3.3V$		2		μA
Thermal Shutdown Threshold (Note 2)	TSD			150		$^{\circ}C$
Thermal Shutdown Hysteresis				30		$^{\circ}C$

Typical Performance Curves

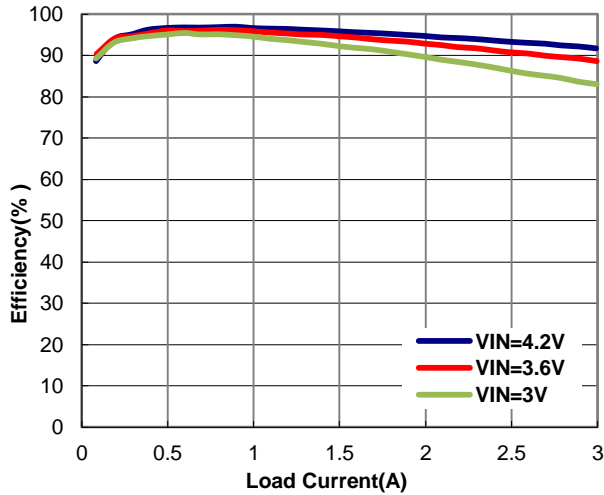

Figure 4. Efficiency vs. Output Current (VOUT=5V)

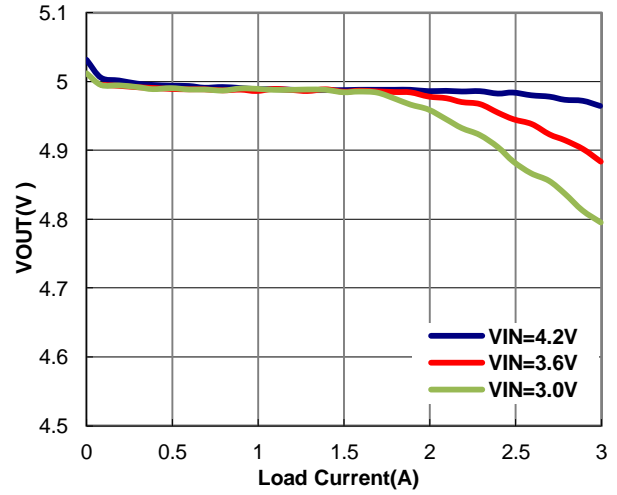

Figure 5. Output Voltage vs. Output Current

V_{IN}=3V, V_{OUT}=5V, I_{OUT}=0A

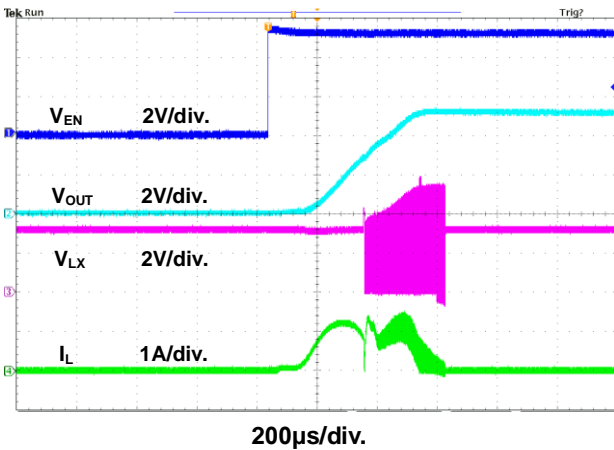

Figure 6. Power On through EN Waveform

V_{IN}=3V, V_{OUT}=5V, I_{OUT}=0A

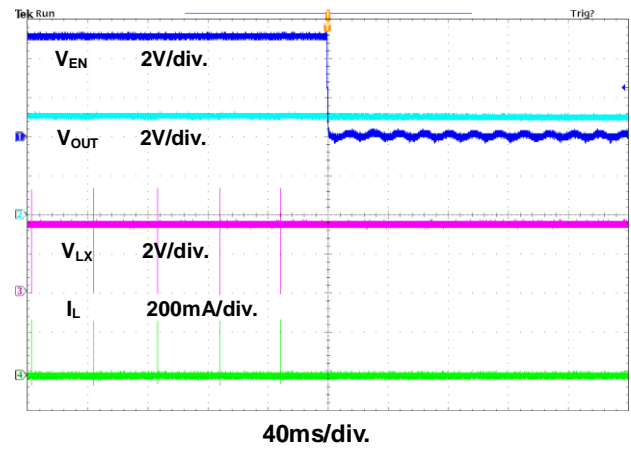

Figure 7. Power Off through EN Waveform

V_{IN}=3V, V_{OUT}=5V, I_{OUT}=0A

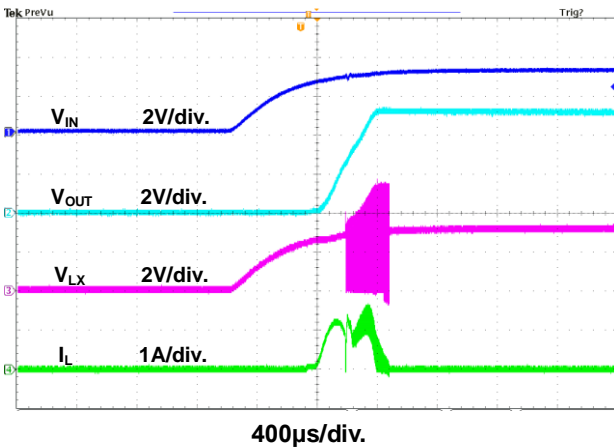

Figure 8. Power On through VIN Waveform

V_{IN}=3V, V_{OUT}=5V, I_{OUT}=0A

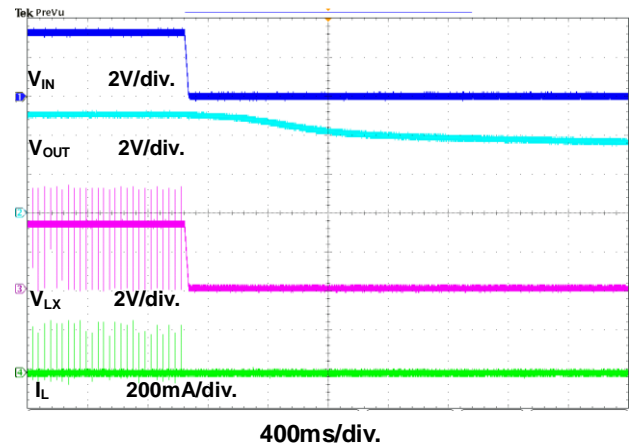

Figure 9. Power Off through VIN Waveform

Typical Performance Curves (Continued)

$V_{IN}=3V, V_{OUT}=5V, I_{OUT}=3A$

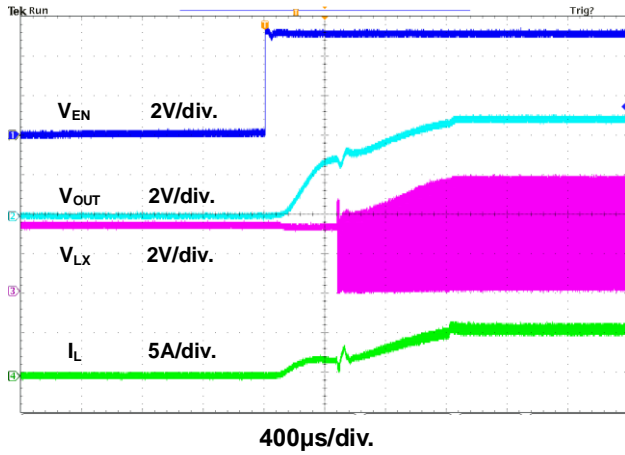

Figure 10. Power On through EN Waveform

$V_{IN}=4.2V, V_{OUT}=5V, I_{OUT}=3A$

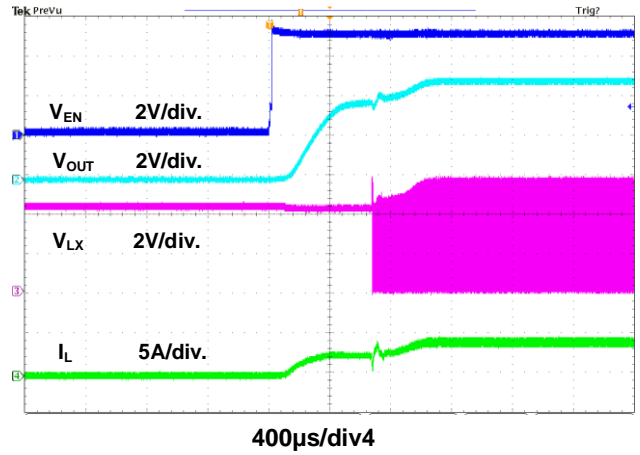
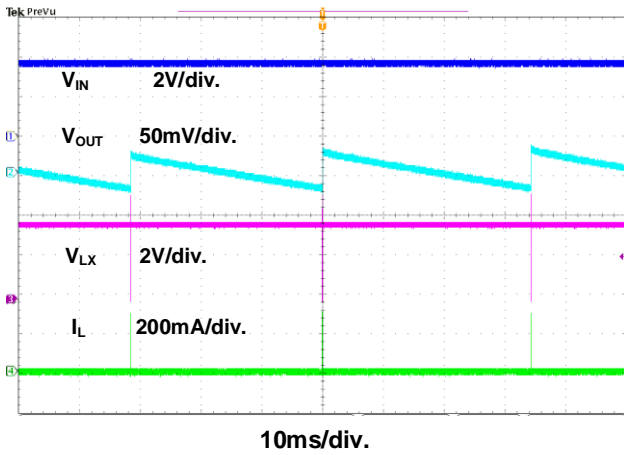
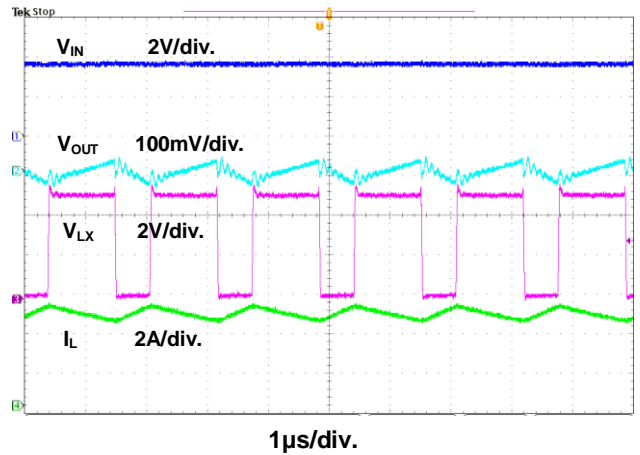

Figure 11. Power On through EN Waveform

$V_{IN}=3.6V, V_{OUT}=5V, I_{OUT}=0A$



$V_{IN}=3.6V, V_{OUT}=5V, I_{OUT}=3A$



$V_{IN}=3V, V_{OUT}=5V, I_{OUT}=0.2A \rightarrow 3A$

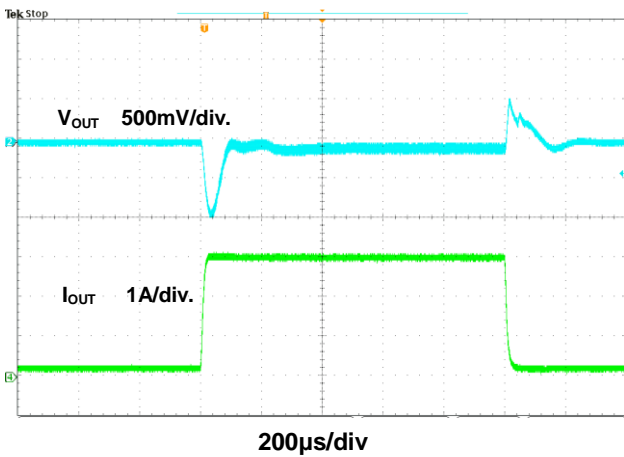

$V_{IN}=4.2V, V_{OUT}=5V, I_{OUT}=0.2A \rightarrow 3A$

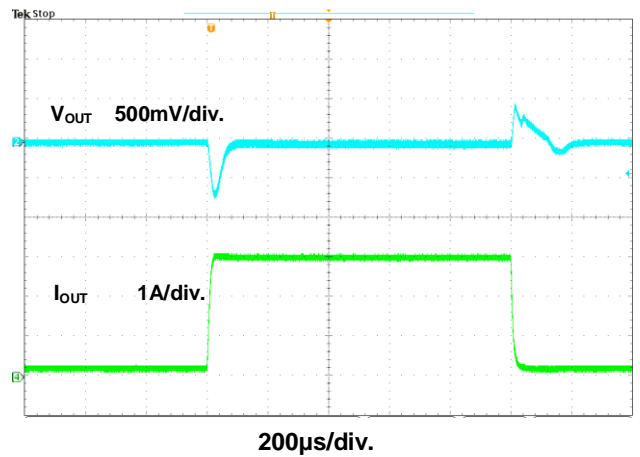

Typical Performance Curves (Continued)

$V_{IN}=3V, V_{OUT}=5V$

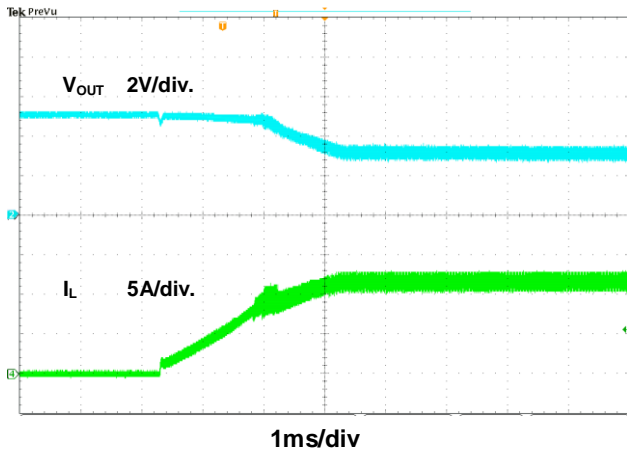

$V_{IN}=4.2V, V_{OUT}=5V$

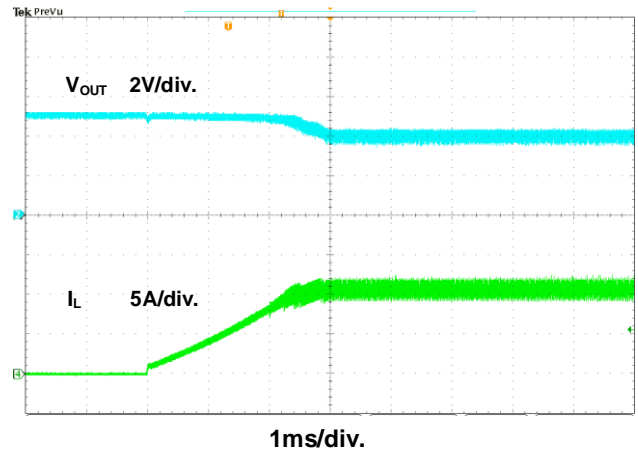

Outline Information

SOP-8 (Exposed Pad) Package (Unit: mm)

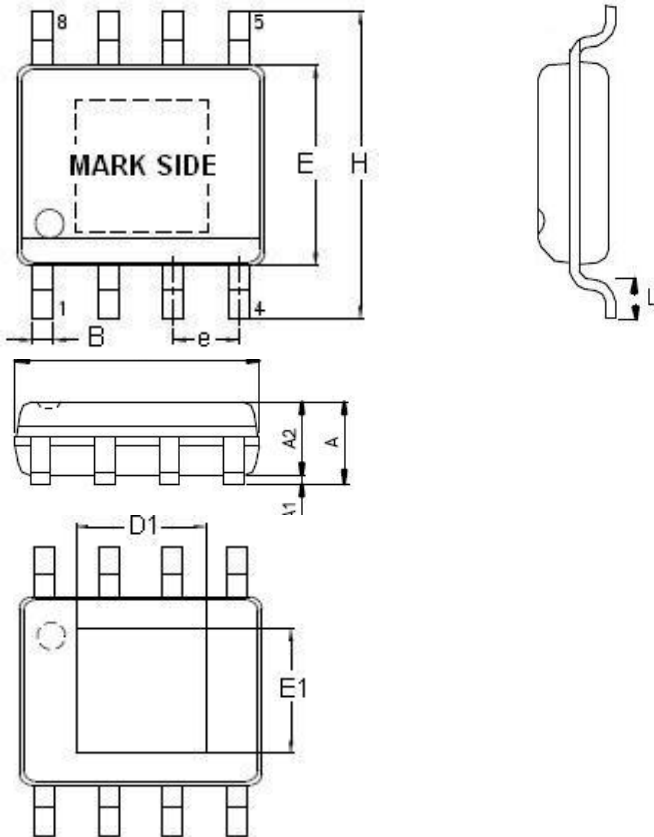

SYMBOLS UNIT	DIMENSION IN MILLIMETER	
	MIN	MAX
A	1.25	1.70
A1	0.00	0.15
A2	1.25	1.55
B	0.31	0.51
D	4.80	5.00
D1	3.04	3.50
E	3.80	4.00
E1	2.15	2.41
e	1.20	1.34
H	5.80	6.20
L	0.40	1.27

Note : Followed From JEDEC MO-012-E.

Carrier Dimensions

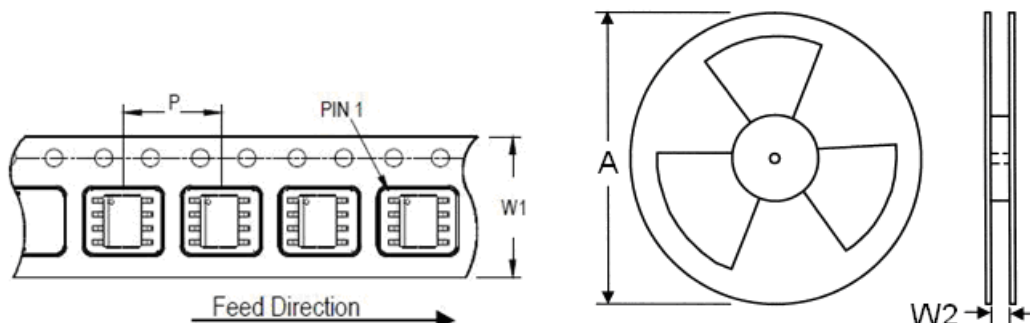

Tape Size (W1) mm	Pocket Pitch (P) mm	Reel Size (A)		Reel Width (W2) mm	Empty Cavity Length mm	Units per Reel
		in	mm			
12	8	13	330	12.4	400~1000	2,500

Life Support Policy

Fitipower's products are not authorized for use as critical components in life support devices or other medical systems.