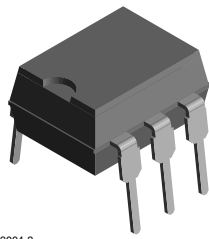
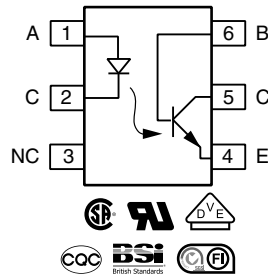




Optocoupler, Phototransistor Output, with Base Connection



H179004-3



FEATURES

- Interfaces with common logic families
- Input-output coupling capacitance < 0.5 pF
- Industry standard dual-in line 6-pin package
- Isolation rated voltage 4420 V_{RMS}
- Material categorization:
for definitions of compliance please see www.vishay.com/doc?99912



RoHS COMPLIANT

DESCRIPTION

The H11Ax family is an industry standard single channel phototransistor coupler. It includes the H11A1, H11A2, H11A3, H11A4, H11A5 couplers.

Each optocoupler consists of gallium arsenide infrared LED and a silicon NPN phototransistor.

The isolation performance is accomplished through Vishay double molding isolation manufacturing process. Compliance to DIN EN 60747-5-5 partial discharge isolation specification is available is by ordering option 1.

These isolation processes and the Vishay ISO9001 quality program results in the highest isolation performance available for a commercial plastic phototransistor optocoupler.

The devices are available in lead formed configuration suitable for surface mounting and are available either on tape and reel, or in standard tube shipping containers.

Note

- Designing with data sheet is covered in Application Note 45.

APPLICATIONS

- AC mains detection
- Reed relay driving
- Switch mode power supply feedback
- Telephone ring detection
- Logic ground isolation
- Logic coupling with high frequency noise rejection

AGENCY APPROVALS

- UL1577, file no. E52744, double protection
- cUL tested to CSA 22.2 bulletin 5A
- CSA 93751
- BSI EN 60950, BSI EN 60065
- DIN EN 60747-5-5 (VDE 0884-5), available with option 1
- FIMKO
- CQC: GB 8898-2011, GB 4943.1-2011

ORDERING INFORMATION	
<div style="display: flex; justify-content: space-around; align-items: center;"> <div style="text-align: center;"> <div style="border: 1px solid black; padding: 2px;">H</div> <div style="border: 1px solid black; padding: 2px;">1</div> <div style="border: 1px solid black; padding: 2px;">1</div> <div style="border: 1px solid black; padding: 2px;">A</div> <div style="border: 1px solid black; padding: 2px;">#</div> </div> <div style="text-align: center;">-</div> <div style="text-align: center;"> <div style="border: 1px solid black; padding: 2px;">X</div> <div style="border: 1px solid black; padding: 2px;">0</div> <div style="border: 1px solid black; padding: 2px;">0</div> <div style="border: 1px solid black; padding: 2px;">#</div> </div> <div style="text-align: center;"> <div style="border: 1px solid black; padding: 2px;">X</div> </div> </div> <p style="text-align: center;"> PART NUMBER PACKAGE OPTION TAPE AND REEL </p>	<div style="display: flex; justify-content: space-around; align-items: center;"> <div style="text-align: center;"> <p>DIP</p> <p>7.62 mm</p> </div> <div style="text-align: center;"> <p>Option 6</p> <p>10.16 mm</p> </div> </div> <div style="text-align: center; margin-top: 10px;"> <p>Option 9</p> <p>> 0.1 mm</p> </div>
AGENCY CERTIFIED/PACKAGE	CTR (%)
UL, CSA, BSI, FIMKO, CQC	> 50
DIP-6	H11A1, H11A1-X001
DIP-6, 400 mil, option 6	H11A1-X006
SMD-6, option 9	H11A1-X009, H11A1-X009T

Note

- Additional options may be possible, please contact sales office.



ABSOLUTE MAXIMUM RATINGS ($T_{amb} = 25\text{ }^{\circ}\text{C}$, unless otherwise specified)				
PARAMETER	TEST CONDITION	SYMBOL	VALUE	UNIT
INPUT				
Reverse voltage		V_R	6	V
Forward current		I_F	60	mA
Surge current	$t \leq 10\text{ }\mu\text{s}$	I_{FSM}	2.5	A
Power dissipation		P_{diss}	100	mW
OUTPUT				
Collector emitter breakdown voltage		V_{CEO}	70	V
Emitter base breakdown voltage		V_{EBO}	7	V
Collector current		I_C	50	mA
	$t < 1\text{ ms}$	I_C	100	mA
Power dissipation		P_{diss}	150	mW
COUPLER				
Storage temperature range		T_{stg}	-55 to +150	$^{\circ}\text{C}$
Operating temperature range		T_{amb}	-55 to +100	$^{\circ}\text{C}$
Junction temperature		T_j	100	$^{\circ}\text{C}$
Soldering temperature	Max. 10 s, dip soldering: distance to seating plane $\geq 1.5\text{ mm}$	T_{sld}	260	$^{\circ}\text{C}$

Note

- Stresses in excess of the absolute maximum ratings can cause permanent damage to the device. Functional operation of the device is not implied at these or any other conditions in excess of those given in the operational sections of this document. Exposure to absolute maximum ratings for extended periods of the time can adversely affect reliability.

ELECTRICAL CHARACTERISTICS ($T_{amb} = 25\text{ }^{\circ}\text{C}$, unless otherwise specified)							
PARAMETER	TEST CONDITION	PART	SYMBOL	MIN.	TYP.	MAX.	UNIT
INPUT							
Forward voltage	$I_F = 10\text{ mA}$	H11A1	V_F		1.1	1.5	V
Reverse current	$V_R = 3\text{ V}$		I_R			10	μA
Capacitance	$V_R = 0\text{ V}$, $f = 1\text{ MHz}$		C_O		50		pF
OUTPUT							
Collector emitter breakdown voltage	$I_C = 1\text{ mA}$, $I_F = 0\text{ mA}$		BV_{CEO}	30			V
Emitter collector breakdown voltage	$I_E = 100\text{ }\mu\text{A}$, $I_F = 0\text{ mA}$		BV_{ECO}	7			V
Collector base breakdown voltage	$I_C = 10\text{ }\mu\text{A}$, $I_F = 0\text{ mA}$		BV_{CBO}	70			V
Collector emitter leakage current	$V_{CE} = 10\text{ V}$, $I_F = 0\text{ mA}$		I_{CEO}		5	50	nA
Emitter collector capacitance	$V_{CE} = 0\text{ V}$		C_{CE}		6		pF
COUPLER							
Collector emitter, saturation voltage	$I_{CE} = 0.5\text{ mA}$, $I_F = 10\text{ mA}$		V_{CEsat}			0.4	V
Capacitance (input-output)			C_{IO}		0.5		pF

Note

- Minimum and maximum values were tested requirements. Typical values are characteristics of the device and are the result of engineering evaluations. Typical values are for information only and are not part of the testing requirements.

CURRENT TRANSFER RATIO							
PARAMETER	TEST CONDITION	PART	SYMBOL	MIN.	TYP.	MAX.	UNIT
I_C/I_F	$V_{CE} = 10\text{ V}$, $I_F = 10\text{ mA}$	H11A1	CTR_{DC}	50			%

SWITCHING CHARACTERISTICS						
PARAMETER	TEST CONDITION	SYMBOL	MIN.	TYP.	MAX.	UNIT
Turn-on time	$I_C = 2\text{ mA}$, $R_L = 100\text{ }\Omega$, $V_{CE} = 10\text{ V}$	t_{on}		3		μs
Turn-off time		t_{off}		3		μs

SAFETY AND INSULATION RATINGS				
PARAMETER	TEST CONDITION	SYMBOL	VALUE	UNIT
Climatic classification	According to IEC 68 part 1		55/100/21	
Comparative tracking index		CTI	175	
Maximum rated withstanding isolation voltage	t = 1 min	V_{ISO}	4420	V_{RMS}
Maximum transient isolation voltage		V_{IOTM}	10 000	V_{peak}
Maximum repetitive peak isolation voltage		V_{IORM}	890	V_{peak}
Isolation resistance	$V_{IO} = 500\text{ V}, T_{amb} = 25\text{ }^{\circ}\text{C}$	R_{IO}	$\geq 10^{12}$	Ω
	$V_{IO} = 500\text{ V}, T_{amb} = 100\text{ }^{\circ}\text{C}$	R_{IO}	$\geq 10^{11}$	Ω
Output safety power		P_{SO}	400	mW
Input safety current		I_{SI}	275	mA
Safety temperature		T_S	175	$^{\circ}\text{C}$
Creepage distance			≥ 7	mm
Clearance distance			≥ 7	mm
Insulation thickness		DTI	≥ 0.4	mm

Note

- As per IEC 60747-5-5, § 7.4.3.8.2, this optocoupler is suitable for “safe electrical insulation” only within the safety ratings. Compliance with the safety ratings shall be ensured by means of protective circuits.

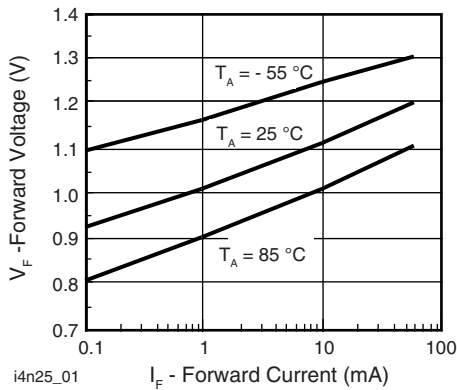
TYPICAL CHARACTERISTICS ($T_{amb} = 25\text{ }^{\circ}\text{C}$, unless otherwise specified)


Fig. 1 - Forward Voltage vs. Forward Current

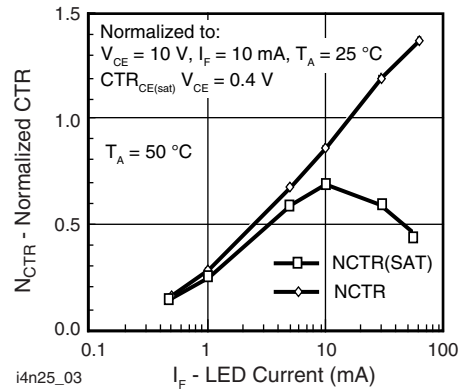


Fig. 3 - Normalized Non-Saturated and Saturated CTR vs. LED Current

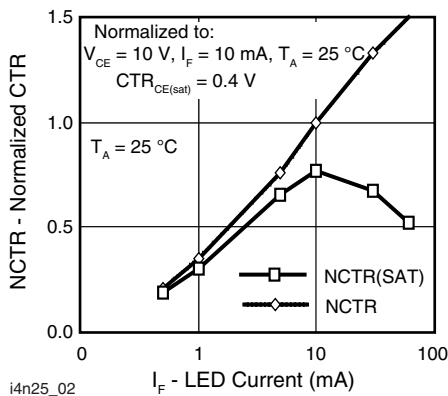


Fig. 2 - Normalized Non-Saturated and Saturated CTR vs. LED Current

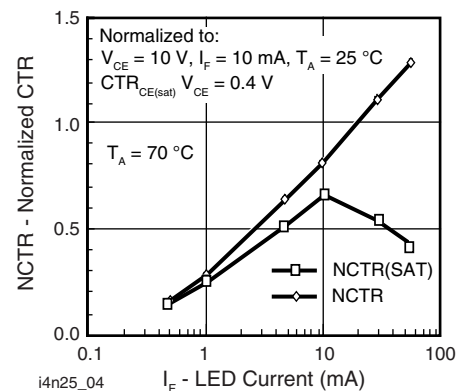


Fig. 4 - Normalized Non-Saturated and Saturated CTR vs. LED Current

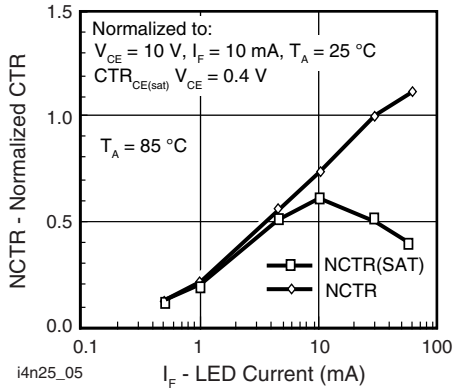


Fig. 5 - Normalized Non-Saturated and Saturated CTR vs. LED Current

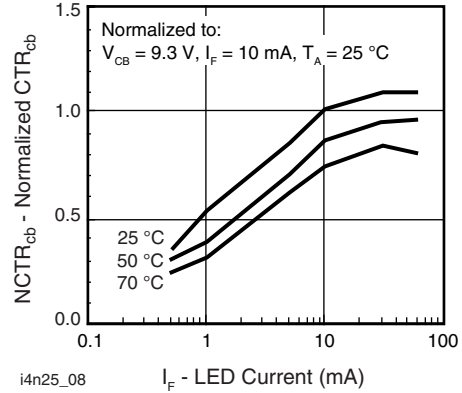


Fig. 8 - Normalized CTR_{cb} vs. LED Current and Temperature

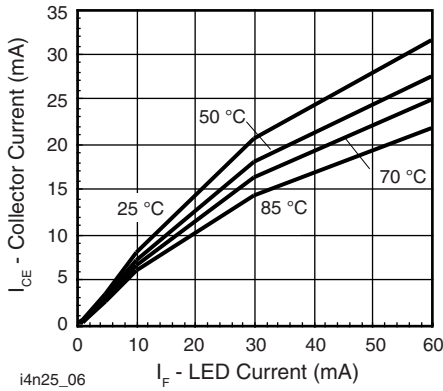


Fig. 6 - Collector Emitter Current vs. Temperature and LED Current

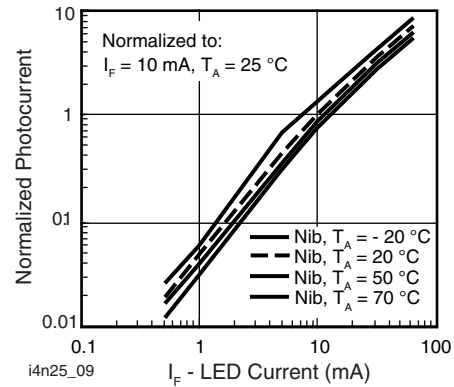


Fig. 9 - Normalized Photocurrent vs. I_F and Temperature

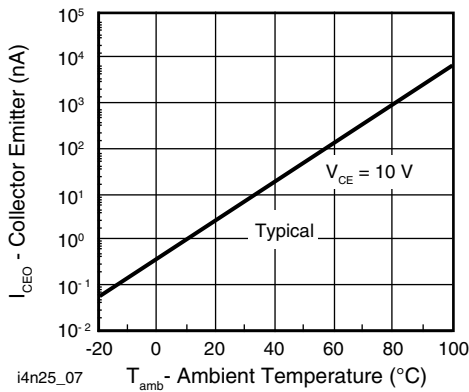


Fig. 7 - Collector Emitter Leakage Current vs. Temperature

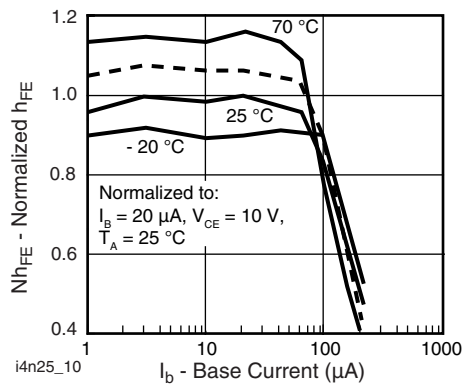


Fig. 10 - Normalized Non-Saturated h_{FE} vs. Base Current and Temperature

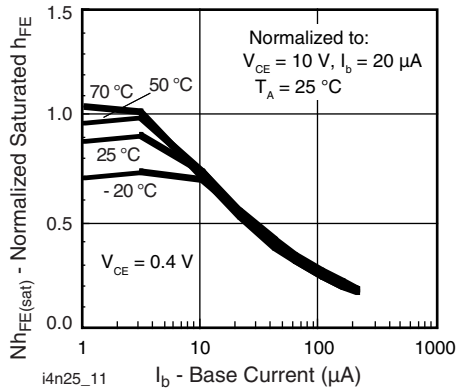
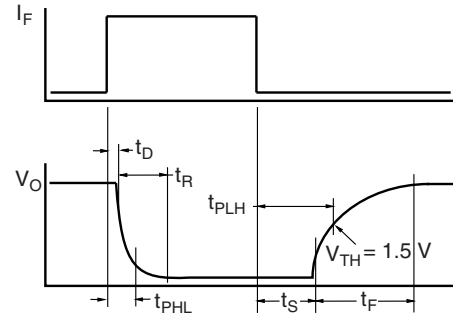
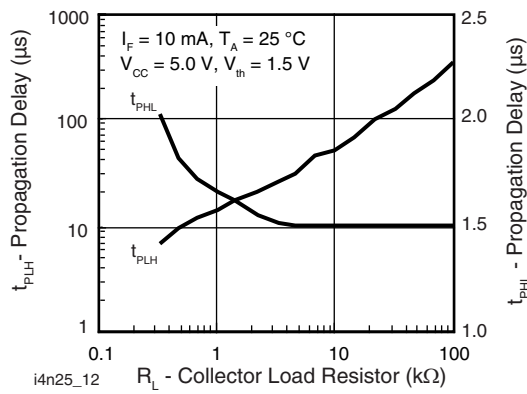


Fig. 11 - Normalized HFE vs. Base Current and Temperature



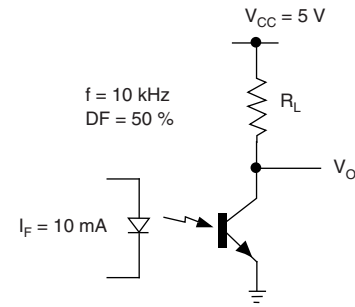
i4n25_13

Fig. 13 - Switching Timing



i4n25_12

Fig. 12 - Propagation Delay vs. Collector Load Resistor



i4n25_14

Fig. 14 - Switching Schematic

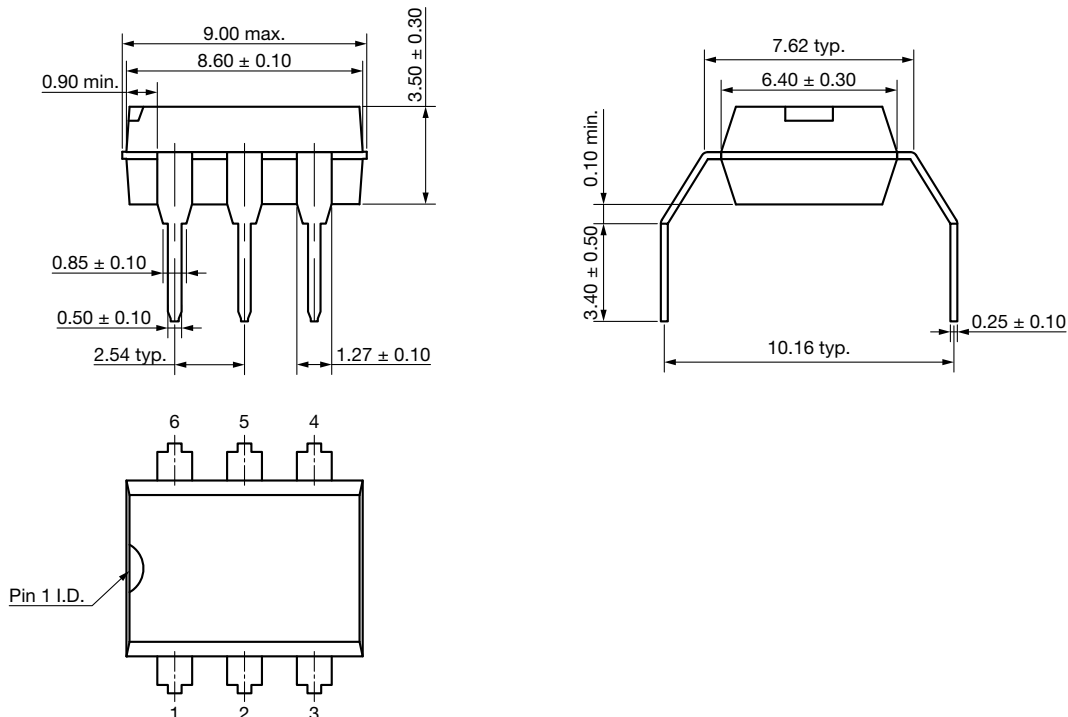


PACKAGE DIMENSIONS in millimeters

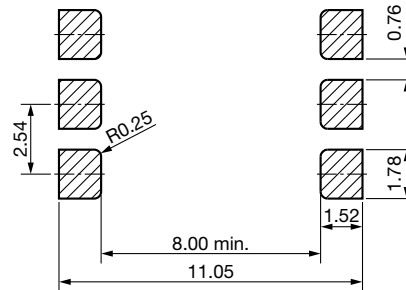
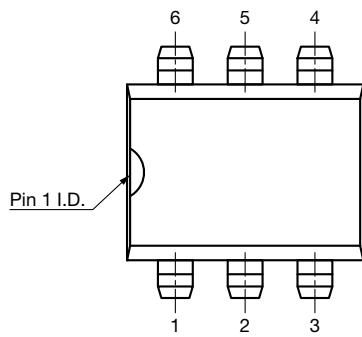
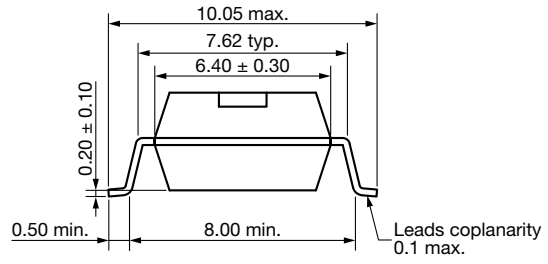
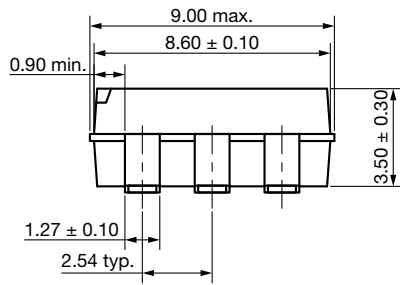
DIP-6



Option 6



Option 9





Disclaimer

ALL PRODUCT, PRODUCT SPECIFICATIONS AND DATA ARE SUBJECT TO CHANGE WITHOUT NOTICE TO IMPROVE RELIABILITY, FUNCTION OR DESIGN OR OTHERWISE.

Vishay Intertechnology, Inc., its affiliates, agents, and employees, and all persons acting on its or their behalf (collectively, "Vishay"), disclaim any and all liability for any errors, inaccuracies or incompleteness contained in any datasheet or in any other disclosure relating to any product.

Vishay makes no warranty, representation or guarantee regarding the suitability of the products for any particular purpose or the continuing production of any product. To the maximum extent permitted by applicable law, Vishay disclaims (i) any and all liability arising out of the application or use of any product, (ii) any and all liability, including without limitation special, consequential or incidental damages, and (iii) any and all implied warranties, including warranties of fitness for particular purpose, non-infringement and merchantability.

Statements regarding the suitability of products for certain types of applications are based on Vishay's knowledge of typical requirements that are often placed on Vishay products in generic applications. Such statements are not binding statements about the suitability of products for a particular application. It is the customer's responsibility to validate that a particular product with the properties described in the product specification is suitable for use in a particular application. Parameters provided in datasheets and / or specifications may vary in different applications and performance may vary over time. All operating parameters, including typical parameters, must be validated for each customer application by the customer's technical experts. Product specifications do not expand or otherwise modify Vishay's terms and conditions of purchase, including but not limited to the warranty expressed therein.

Except as expressly indicated in writing, Vishay products are not designed for use in medical, life-saving, or life-sustaining applications or for any other application in which the failure of the Vishay product could result in personal injury or death. Customers using or selling Vishay products not expressly indicated for use in such applications do so at their own risk. Please contact authorized Vishay personnel to obtain written terms and conditions regarding products designed for such applications.

No license, express or implied, by estoppel or otherwise, to any intellectual property rights is granted by this document or by any conduct of Vishay. Product names and markings noted herein may be trademarks of their respective owners.