

SIGN	DATE	DESCRIPTION	APPROVER
△	08.09	NEW PRODUCT ISSUE	nierzhenqi
△			
△			

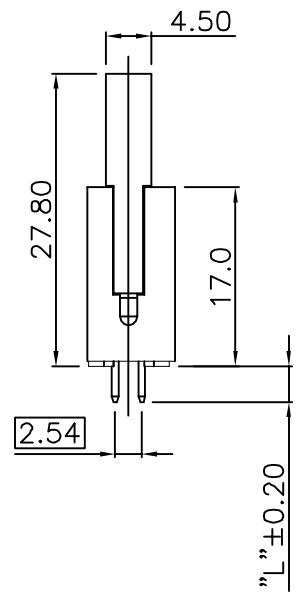
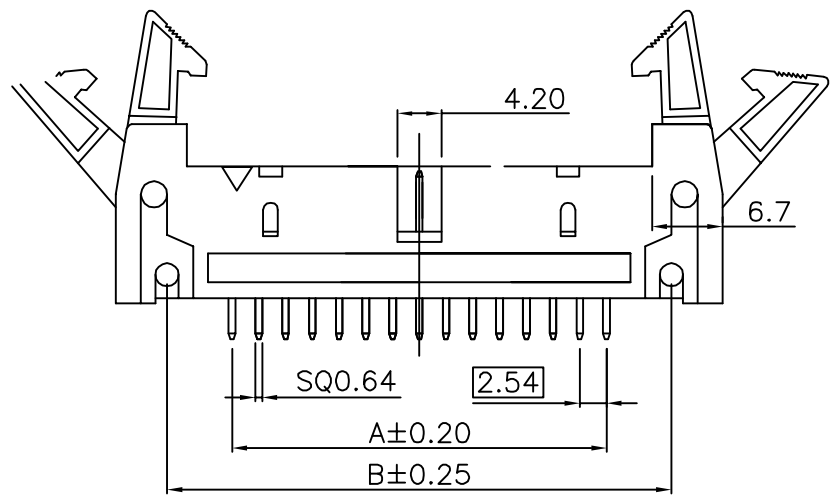

- NOTES:
- MATERIALS:
    - INSULATOR: PBT+30%GF UL94V-0, BLACK.
    - CONTACT: Copper ALLOY.
    - PLATED: CONTACT GOLD PLATED OVER Ni.
  - ELECTRICAL CHARACTERISTICS:
    - CURRENT RATING: 3 Amp.
    - CONTACT RESISTANCE: 20 mOhms Max.
    - WITHSTANDING VOLTAGE: 500V AC Min.
    - INSULATION RESISTANCE: 1000 MOhms Min.
    - Operation Temperature: -40° C~+105° C.

Part NO.

230-0\*0-\*\*\*-20\*

Solder length  
Dim "L"  
1:3.4  
3:4.0  
4:2.9  
7:4.5  
Housing Color  
0:Black  
6:Blue  
8:Grey

Plated  
2:G/F  
3:Au 10u"  
4:Au 15u"  
5:Au 30u"  
9:Au 3u"  
A:Au 5u"  
NO. Of Positions  
6~64

PIN	A±0.20	B±0.25	C±0.20	D±0.25
6	5.08	16.76	22.86	26.92
8	7.62	19.30	25.40	29.46
10	10.16	21.84	27.94	32.00
14	15.24	26.92	33.02	37.08
16	17.78	29.46	35.56	39.62
18	20.32	32.00	38.10	42.16
20	22.86	34.54	40.64	44.70
24	27.94	39.62	45.72	49.78
26	30.48	42.16	48.26	52.32
30	35.56	47.24	53.34	57.40
34	40.64	52.32	58.42	62.48
40	48.26	59.94	66.04	70.10
50	60.96	72.64	78.74	82.80
60	73.66	85.35	91.44	95.50
64	78.74	90.42	96.52	100.58

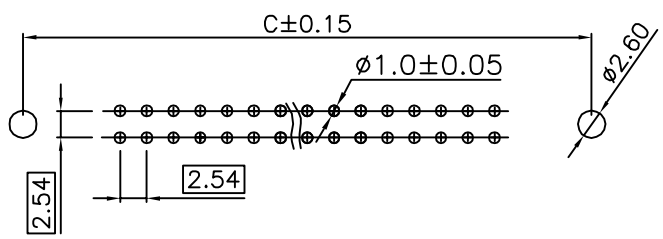
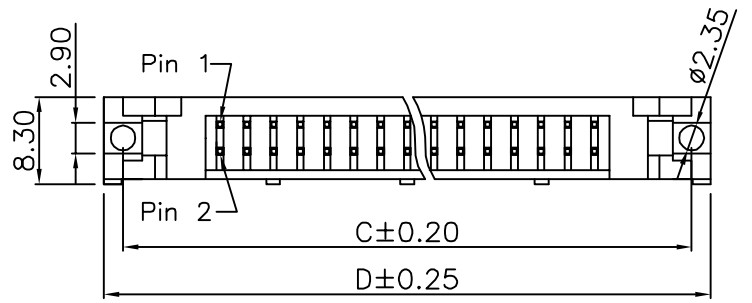

PCB LAYOUT

**nexttron** 正凌精密工业股份有限公司  
NEXTRONICS ENGINEERING CORP

PART. NAME: xxPIN 2.54mm EJECTOR HEADER CONNECTOR				TITLE: 2.54mm EJECTOR HEADER STRAIGHT Type	
PART. NO.: SEE TABLE				DWG NAME: 230-010-820-209	
APPROVED BY	CHECKED BY	DESIGNED BY	DRAWN BY	CUSTOM NO.:	Tolerance
jeff	jeff		nierzhenqi		x. ±0.50
				UNITS: mm	x.x ±0.20
				SCALE:	x.xx ±0.10
				REVISION:	xx' ±1"