

Features

- -16V/-8A,
 $R_{DS(ON)} = 40m\Omega(Typ.)@V_{GS}=-4.5V$
 $R_{DS(ON)} = 65m\Omega(Typ.)@V_{GS}=-2.5V$
- Super High Dense Cell Design
- Fast Switching Speed
- Reliable and Rugged
- Lead Free and Green Devices Available (RoHS Compliant)

Applications

- Load Switch
- Battery Charge
- DC/DC Converters

Pin Description

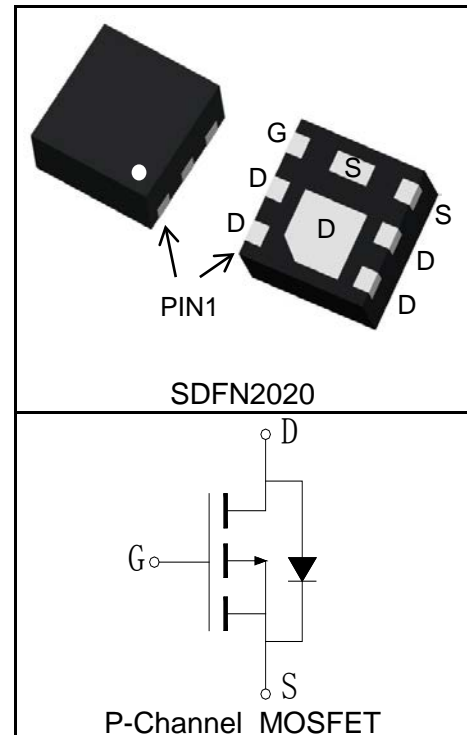

Absolute Maximum Ratings

Symbol	Parameter	Rating	Unit
Common Ratings ($T_C=25^\circ C$ Unless Otherwise Noted)			
V_{DSS}	Drain-Source Voltage	-16	V
V_{GSS}	Gate-Source Voltage	± 12	
T_J	Maximum Junction Temperature	150	$^\circ C$
T_{STG}	Storage Temperature Range	-55 to 150	$^\circ C$
I_S	Diode Continuous Forward Current	$T_C=25^\circ C$ -14	A
Mounted on Large Heat Sink			
$I_{DP}^{①}$	300 μs Pulse Drain Current Tested	$T_C=25^\circ C$ -56	A
$I_D^{②}$	Continuous Drain Current@ $T_C(V_{GS}=-4.5V)$	$T_C=25^\circ C$ -14	A
		$T_C=100^\circ C$ -9	
	Continuous Drain Current@ $T_A(V_{GS}=-4.5V)^{③}$	$T_A=25^\circ C$ -8	
		$T_A=70^\circ C$ -5.6	
P_D	Maximum Power Dissipation@ T_C	$T_C=25^\circ C$ 17.8	W
		$T_C=100^\circ C$ 7.1	
	Maximum Power Dissipation@ $T_A^{③}$	$T_A=25^\circ C$ 2.5	
		$T_A=70^\circ C$ 1.6	

Symbol	Parameter	Rating	Unit
$R_{\theta JC}$	Thermal Resistance-Junction to Case	7	°C/W
$R_{\theta JA}^{(3)}$	Thermal Resistance-Junction to Ambient	50	°C/W
Drain-Source Avalanche Ratings			
$E_{AS}^{(4)}$	Avalanche Energy, Single Pulsed	TBD	mJ

Electrical Characteristics ($T_C=25^\circ\text{C}$ Unless Otherwise Noted)

Symbol	Parameter	Test Condition	RU16P8M4			Unit
			Min.	Typ.	Max.	
Static Characteristics						
BV_{DSS}	Drain-Source Breakdown Voltage	$V_{GS}=0V, I_{DS}=-250\mu A$	-16			V
I_{DSS}	Zero Gate Voltage Drain Current	$V_{DS}=-16V, V_{GS}=0V$			-1	μA
		$T_J=125^\circ\text{C}$			-30	
$V_{GS(th)}$	Gate Threshold Voltage	$V_{DS}=V_{GS}, I_{DS}=-250\mu A$	-0.4		-1.1	V
I_{GSS}	Gate Leakage Current	$V_{GS}=\pm 12V, V_{DS}=0V$			± 100	nA
$R_{DS(ON)}^{(5)}$	Drain-Source On-state Resistance	$V_{GS}=-4.5V, I_{DS}=-4A$		40	50	$m\Omega$
		$V_{GS}=-2.5V, I_{DS}=-3A$		65	80	$m\Omega$
Diode Characteristics						
$V_{SD}^{(5)}$	Diode Forward Voltage	$I_{SD}=-1A, V_{GS}=0V$			-1.2	V
t_{rr}	Reverse Recovery Time	$I_{SD}=-4A, dI_{SD}/dt=100A/\mu s$		8		ns
Q_{rr}	Reverse Recovery Charge			3		nC
Dynamic Characteristics⁽⁶⁾						
R_G	Gate Resistance	$V_{GS}=0V, V_{DS}=0V, F=1\text{MHz}$		0.6		Ω
C_{iss}	Input Capacitance	$V_{GS}=0V,$ $V_{DS}=-8V,$ Frequency=1.0MHz		500		pF
C_{oss}	Output Capacitance			90		
C_{riss}	Reverse Transfer Capacitance			45		
$t_{d(ON)}$	Turn-on Delay Time	$V_{DD}=-8V, I_{DS}=-4A,$ $V_{GEN}=-4.5V, R_G=6\Omega$		5		ns
t_r	Turn-on Rise Time			10		
$t_{d(OFF)}$	Turn-off Delay Time			21		
t_f	Turn-off Fall Time			9		
Gate Charge Characteristics⁽⁶⁾						
Q_g	Total Gate Charge	$V_{DS}=-12V, V_{GS}=-4.5V,$ $I_{DS}=-4A$		8		nC
Q_{gs}	Gate-Source Charge			1.3		
Q_{gd}	Gate-Drain Charge			2.5		

- Notes:
- ① Pulse width limited by safe operating area.
 - ② Calculated continuous current based on maximum allowable junction temperature.
 - ③ When mounted on 1 inch square copper board, $t \leq 10\text{sec}$.
 - ④ Limited by $T_{J\text{max}}$, Starting $T_J = 25^\circ\text{C}$.
 - ⑤ Pulse test; Pulse width $\leq 300\mu\text{s}$, duty cycle $\leq 2\%$.
 - ⑥ Guaranteed by design, not subject to production testing.

Ordering and Marking Information

Device	Marking	Package	Packaging	Quantity	Reel Size	Tape width
RU16P8M4	16P8	SDFN2020	Tape&Reel	3000	7"	8mm

Typical Characteristics

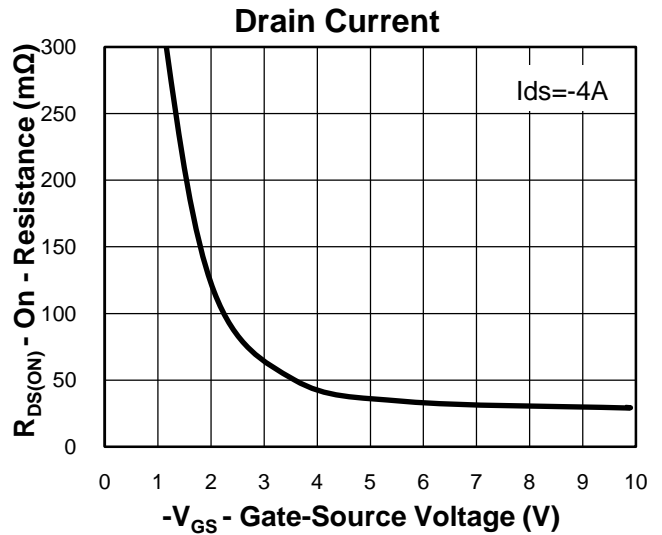
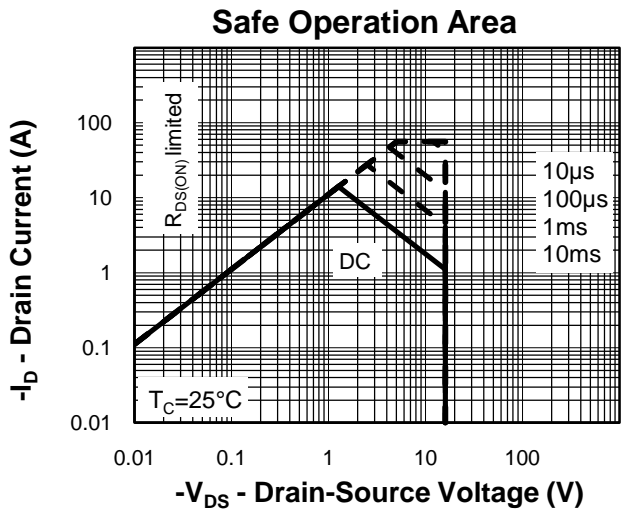
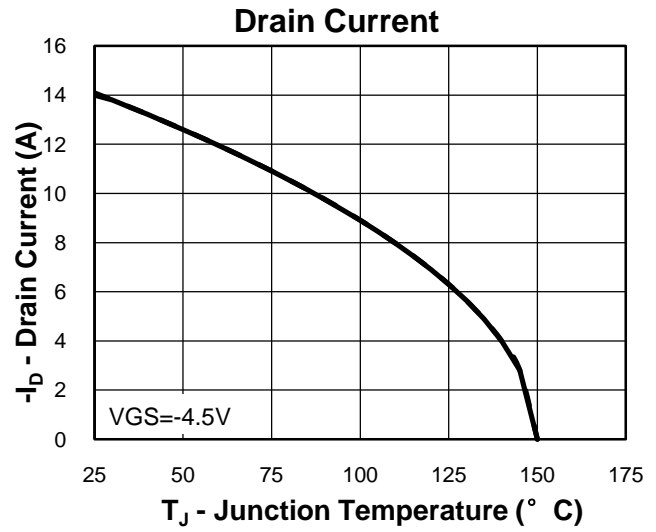
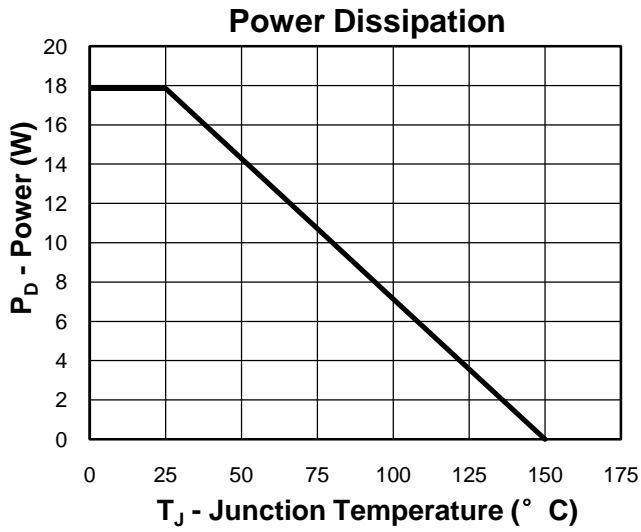

Thermal Transient Impedance

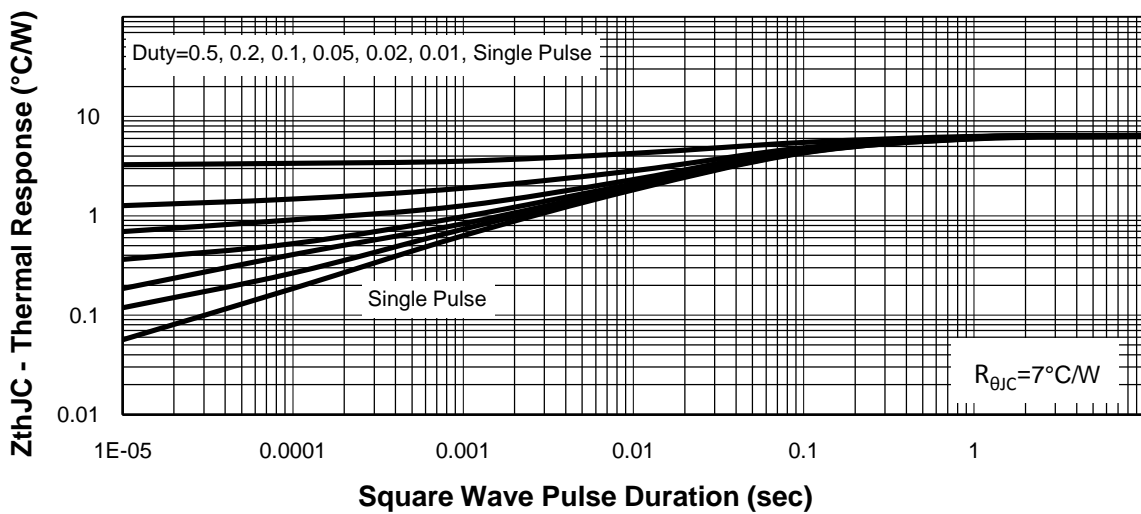

Typical Characteristics

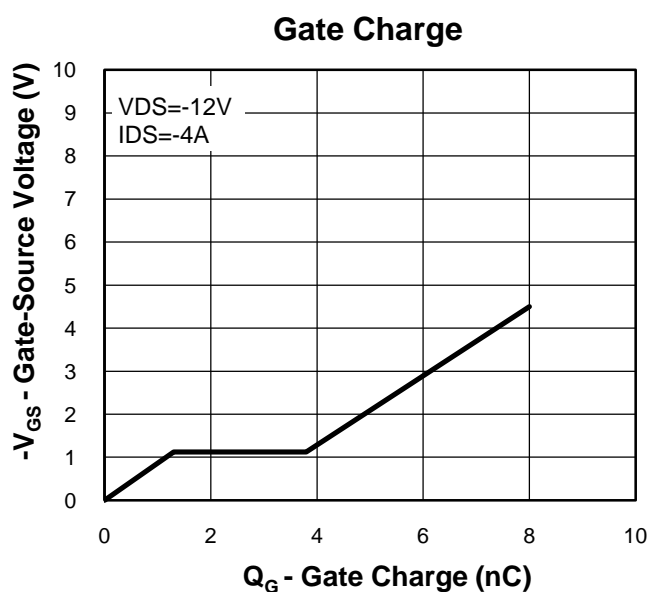
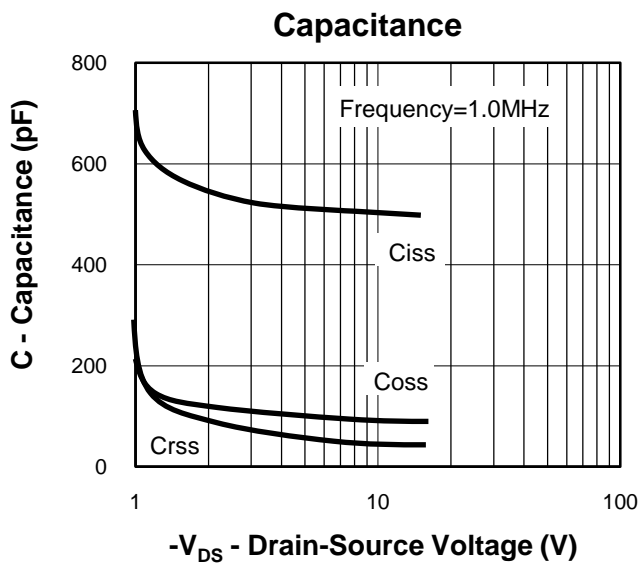
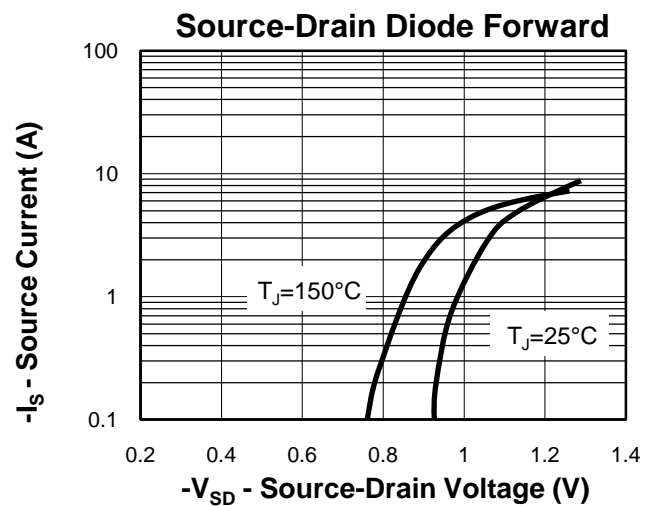
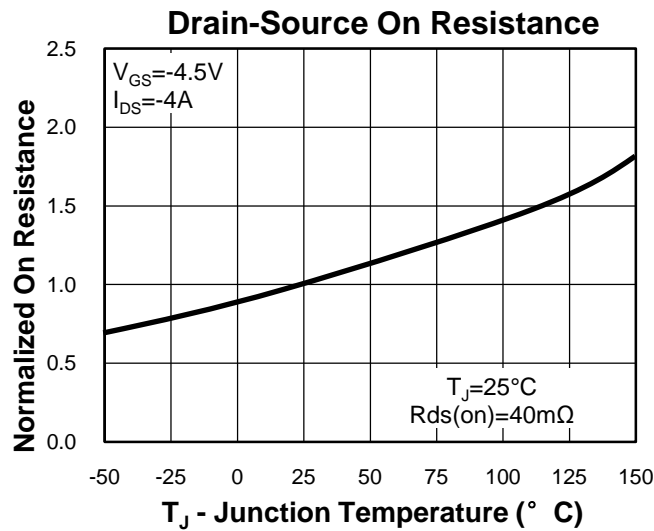
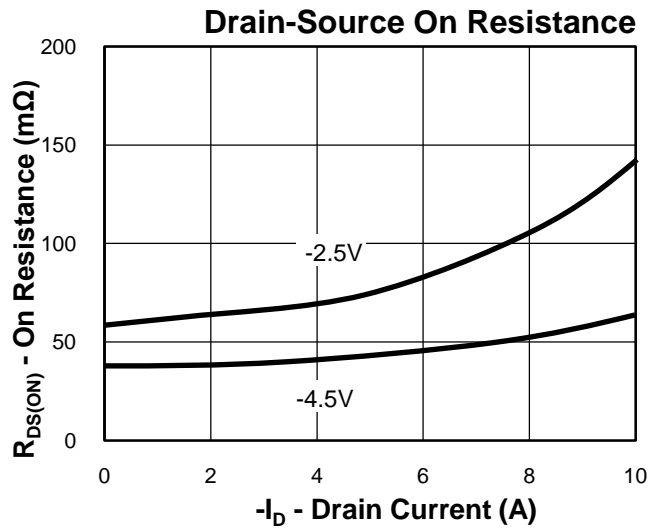
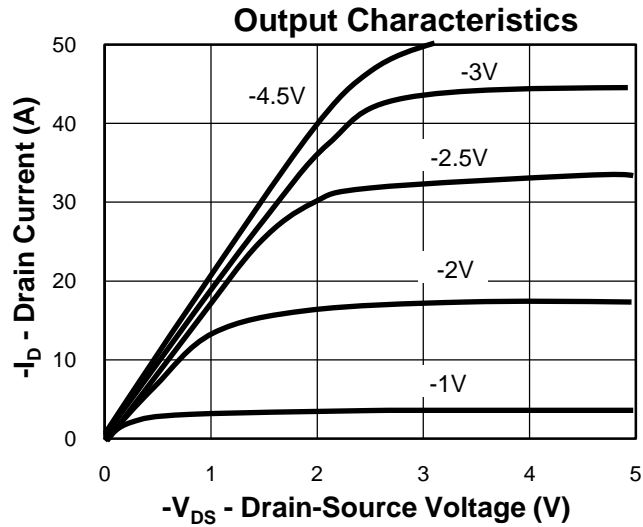

Avalanche Test Circuit and Waveforms

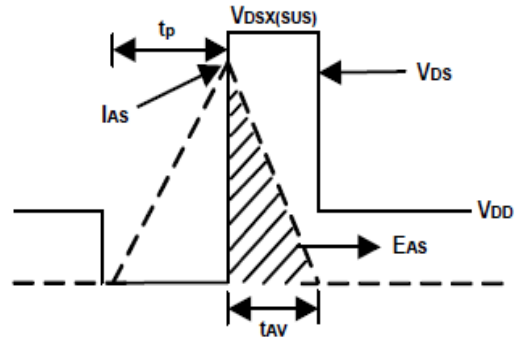
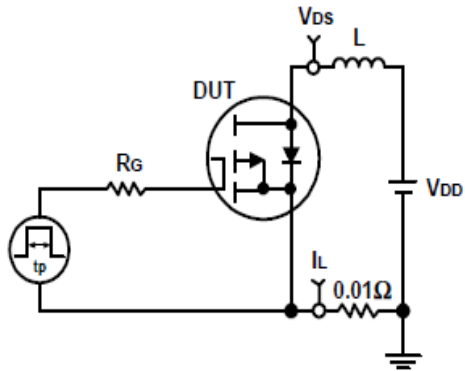

Switching Time Test Circuit and Waveforms

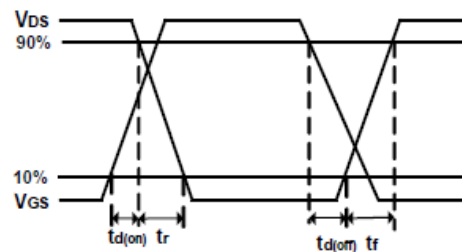
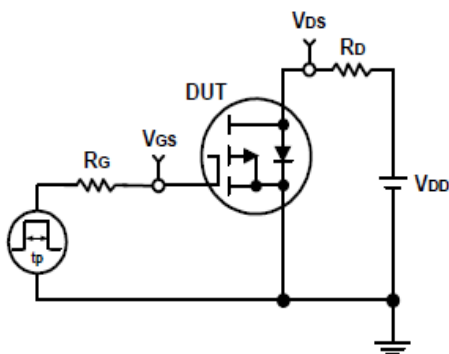

Package Information

SDFN2020

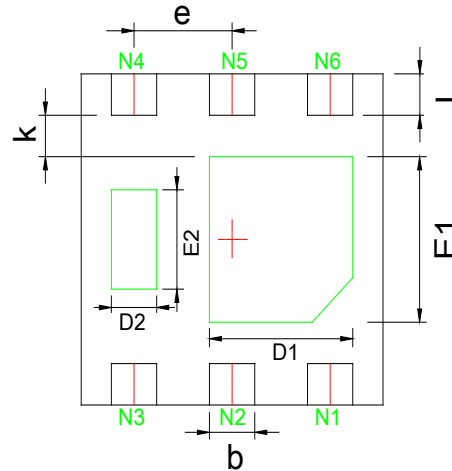
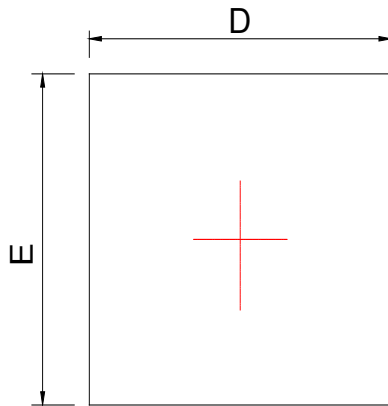

Land Pattern
(Only for Reference)

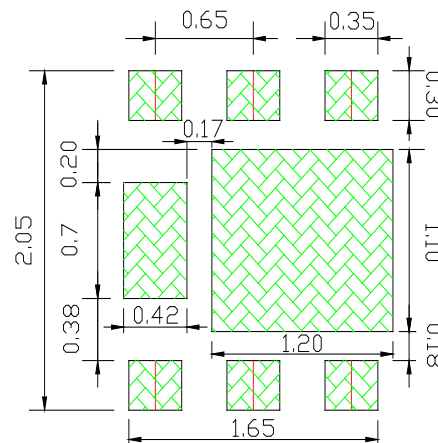
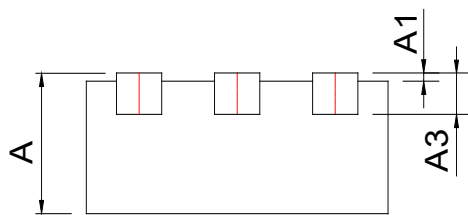

SYMBOL	MM			INCH		
	MIN	NOM	MAX	MIN	NOM	MAX
A	0.700	0.750	0.800	0.028	0.030	0.031
A1	0.000	0.025	0.050	0.000	0.001	0.002
A3	0.203 REF.			0.008 REF.		
D	1.924	2.000	2.076	0.076	0.079	0.082
E	1.924	2.000	2.076	0.076	0.079	0.082
D1	0.800	0.900	1.000	0.031	0.035	0.039
E1	0.850	0.950	1.050	0.033	0.037	0.041
D2	0.200	0.300	0.400	0.008	0.012	0.016
E2	0.460	0.560	0.660	0.018	0.022	0.026
K	0.200 MIN.			0.008 MIN.		
b	0.250	0.300	0.350	0.010	0.012	0.014
e	0.650 TYP			0.026 TYP		
L	0.174	0.250	0.326	0.007	0.010	0.013

Customer Service**Worldwide Sales and Service:**

Sales@ruichips.com

Technical Support:

Technical@ruichips.com

Investor Relations Contacts:

Investor@ruichips.com

Marcom Contact:

Marcom@ruichips.com

Editorial Contact:

Editorial@ruichips.com

HR Contact:

HR@ruichips.com

Legal Contact:

Legal@ruichips.com

Shen Zhen RUICHIPS Semiconductor CO., LTDRoom 501, the 5floor An Tong Industrial Building,
NO.207 Mei Hua Road Fu Tian Area Shen Zhen City, CHINA**TEL:** (86-755) 8311-5334**FAX:** (86-755) 8311-4278**E-mail:** Sales-SZ@ruichips.com