

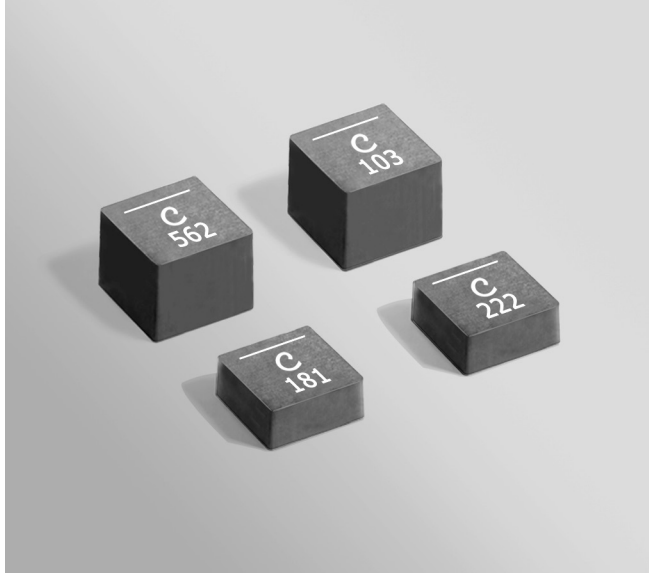

Shielded Power Inductors – XAL50xx



- High current; very low DCR; soft saturation
- AEC-200 Grade 1 (–40°C to +125°C)

Designer's Kit C445 contains 3 of each value

Core material Composite

Environmental RoHS compliant, halogen free

Terminations RoHS compliant tin-silver (96.5/3.5) over copper
Other terminations available at additional cost.

Weight XAL5030: 0.44 – 0.51 g; XAL5050: 0.74 – 0.80 g

Operating voltage: 0 – 60 V

Ambient temperature –40°C to +125°C with (40°C rise) Irms current.

Maximum part temperature +165°C (ambient + temp rise). [Derating.](#)

Storage temperature Component: –55°C to +165°C.

Tape and reel packaging: –55°C to +80°C

Resistance to soldering heat Max three 40 second reflows at +260°C, parts cooled to room temperature between cycles

Moisture Sensitivity Level (MSL) 1 (unlimited floor life at <30°C / 85% relative humidity)

PCB washing Tested to MIL-STD-202 Method 215 plus an additional aqueous wash. See [Doc787 PCB Washing.pdf](#).

Part number ¹	Inductance ² ±20% (µH)	DCR (mOhms) ³		SRF typ ⁴ (MHz)	Isat ⁵ (A)	Irms (A) ⁶	
		typ	max			20°C rise	40°C rise
XAL5030-161ME_	0.16	2.15	2.36	183	31.0	14.2	22.2
XAL5030-331ME_	0.33	3.20	3.52	108	26.0	13.8	19.2
XAL5030-601ME_	0.60	4.11	4.52	75	19.8	13.6	17.7
XAL5030-801ME_	0.80	5.14	5.65	63	18.5	10.0	13.0
XAL5030-102ME_	1.0	8.50	9.40	68	14.0	8.7	11.1
XAL5030-122ME_	1.2	11.40	12.40	45	12.5	7.9	10.4
XAL5030-222ME_	2.2	13.20	14.50	38	9.2	7.2	9.7
XAL5030-332ME_	3.3	21.20	23.30	28	8.7	5.9	8.1
XAL5030-472ME_	4.7	36.00	40.00	23	6.7	4.3	5.9
XAL5050-562ME_	5.6	23.45	25.80	25	6.3	5.3	7.2
XAL5050-682ME_	6.8	26.75	29.45	21	6.0	4.7	6.4
XAL5050-822ME_	8.2	31.75	34.95	18	5.6	4.5	6.1
XAL5050-103ME_	10	40.90	45.00	15	4.9	3.6	4.9
XAL5050-153ME_	15	69.70	76.70	13	3.7	2.9	3.9
XAL5050-223ME_	22	90.60	99.65	11	3.6	2.5	3.4

Irms Testing

Irms testing was performed on 0.75 inch wide × 0.25 inch thick copper traces in still air.

Temperature rise is highly dependent on many factors including pcb land pattern, trace size, and proximity to other components. Therefore temperature rise should be verified in application conditions.

1. When ordering, please specify **termination** and **packaging** code:

XAL5050-223MEC

Termination: E = Halogen free component. RoHS compliant tin-silver over copper terminations.
Special order: T = RoHS tin-silver-copper (95.5/4/0.5) or S = non-RoHS tin-lead (63/37).

Packaging: C = 7" machine-ready reel. EIA-481 embossed plastic tape. Quantities less than full reel available: in tape (not machine ready) or with leader and trailer (\$25 charge).

B = Less than full reel. In an effort to simplify our part numbering system, Coilcraft is eliminating the need for multiple packaging codes. When ordering, simply change the last letter of your part number from B to C.

D = 13" machine-ready reel. EIA-481 embossed plastic tape. Factory order only, not stocked

2. Inductance tested at 1 MHz, 0.1 Vrms, 0 Adc.

3. DCR measured on a micro-ohmmeter.

4. SRF measured using Agilent/HP 4395A or equivalent.

5. DC current at 25°C that causes an inductance drop of 30% (typ) from its value without current.

[Click for temperature derating information.](#)

6. Current that causes the specified temperature rise from 25°C ambient. This information is for reference only and does not represent absolute maximum ratings. [Click for temperature derating information.](#)

7. Electrical specifications at 25°C.

Refer to Doc 362 "Soldering Surface Mount Components" before soldering.



www.coilcraft.com

US +1-847-639-6400 sales@coilcraft.com

UK +44-1236-730595 sales@coilcraft-europe.com

Taiwan +886-2-2264 3646 sales@coilcraft.com.tw

China +86-21-6218 8074 sales@coilcraft.com.cn

Singapore + 65-6484 8412 sales@coilcraft.com.sg

Document 908-1 Revised 06/23/21

© Coilcraft Inc. 2021

This product may not be used in medical or high risk applications without prior Coilcraft approval. Specification subject to change without notice. Please check web site for latest information

HIGH TEMPERATURE

Shielded Power Inductors – XAL50^{XX}

L vs Current

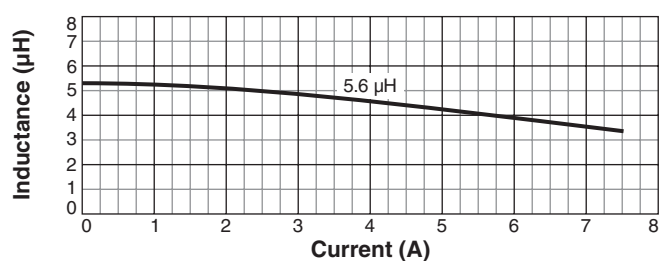
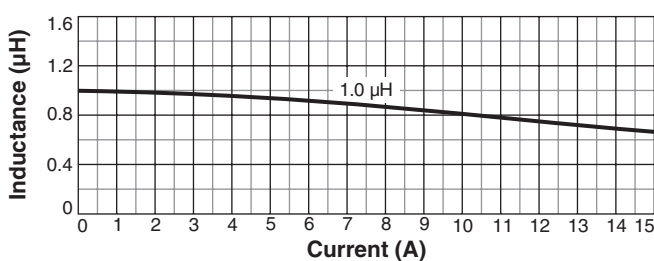
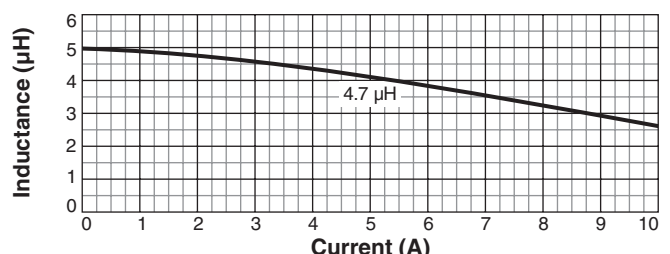
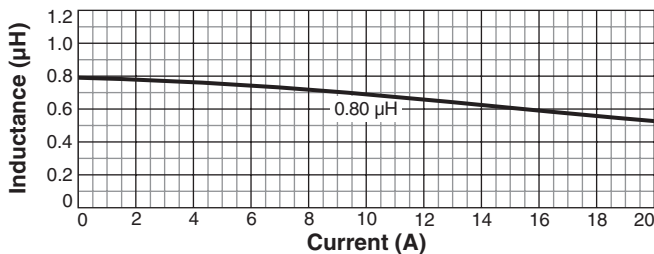
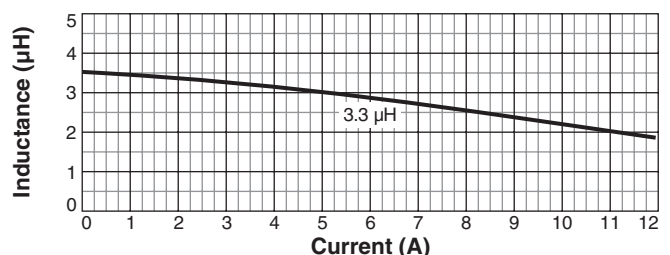
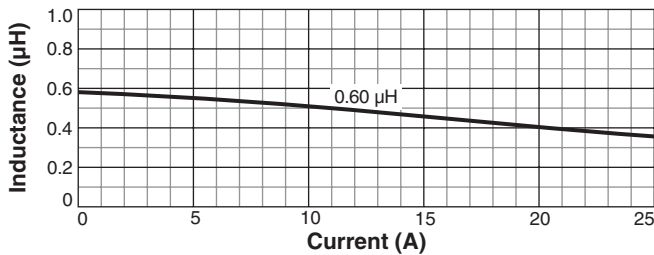
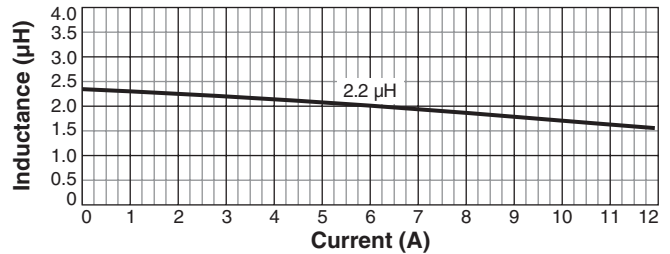
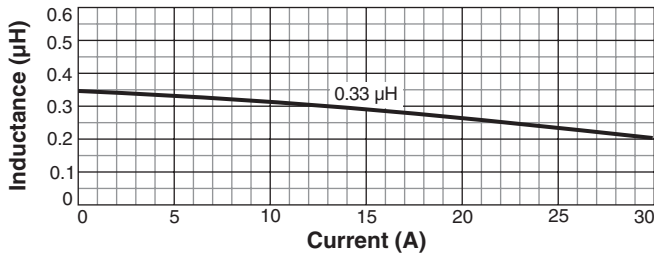
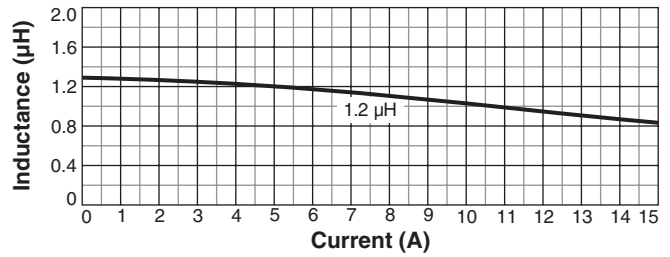
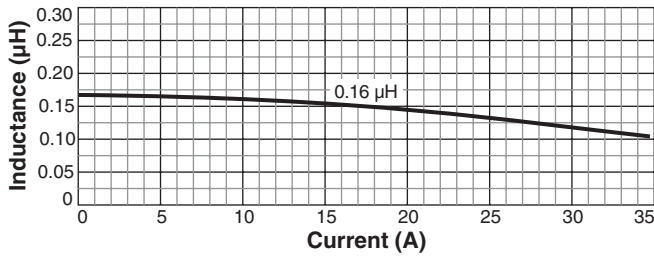

US +1-847-639-6400 sales@coilcraft.com
UK +44-1236-730595 sales@coilcraft-europe.com
Taiwan +886-2-2264 3646 sales@coilcraft.com.tw
China +86-21-6218 8074 sales@coilcraft.com.cn
Singapore + 65-6484 8412 sales@coilcraft.com.sg

Document 908-2 Revised 06/23/21

© Coilcraft Inc. 2021

This product may not be used in medical or high risk applications without prior Coilcraft approval. Specification subject to change without notice. Please check web site for latest information.

HIGH TEMPERATURE

Shielded Power Inductors – XAL50^{XX}

L vs Current

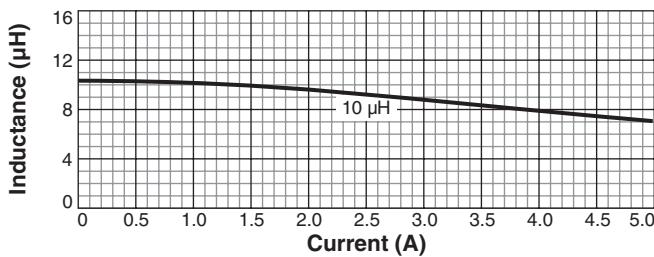
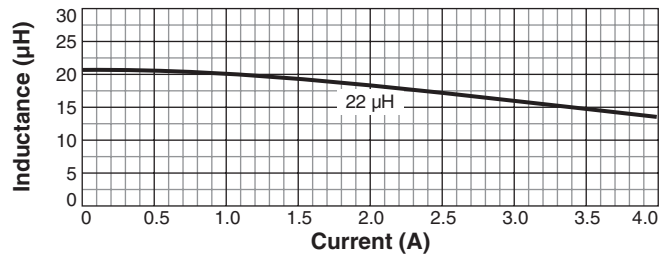
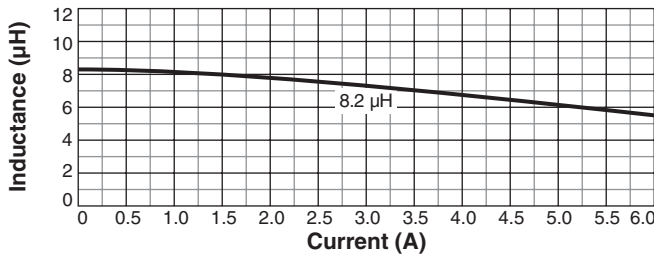
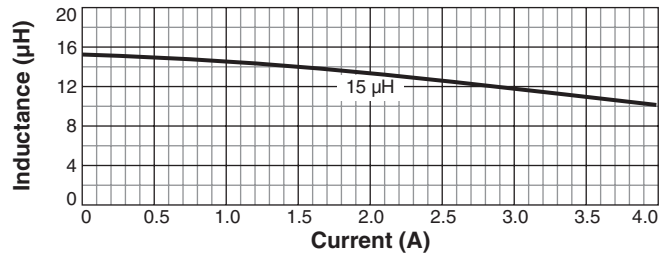
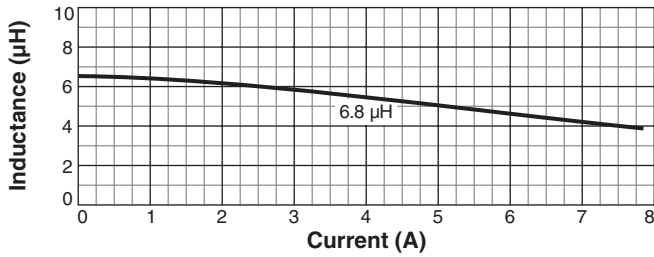

HIGH TEMPERATURE

Shielded Power Inductors – XAL50xx

Typical L vs Frequency

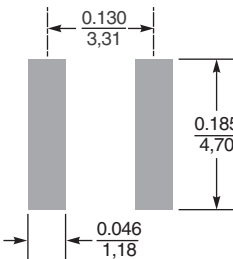
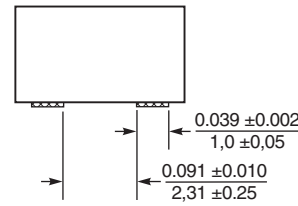
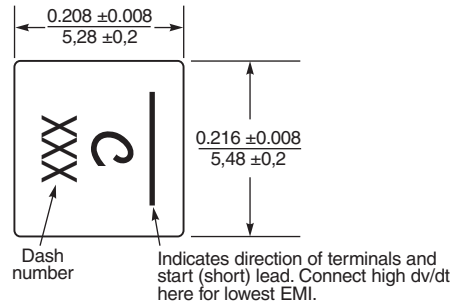
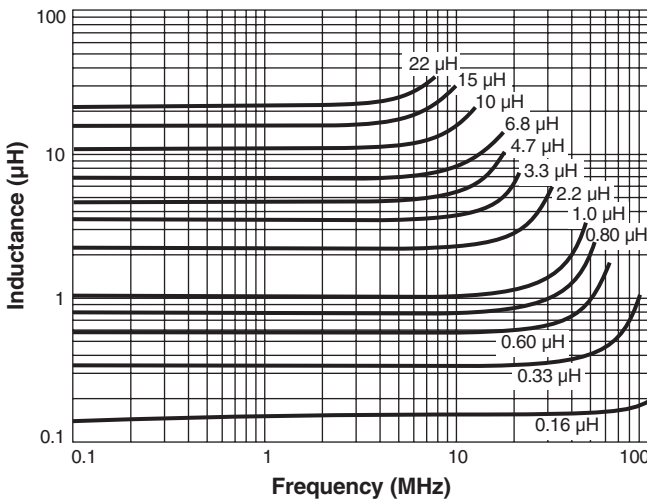

Recommended Land Pattern

Dimensions are in $\frac{\text{inches}}{\text{mm}}$

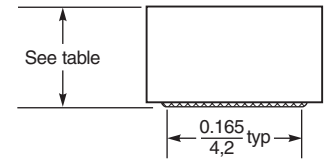

Dash number	Height* max (in / mm)
-161	0.122 / 3.1
-331	0.122 / 3.1
-601	0.122 / 3.1
-801	0.122 / 3.1
-102	0.122 / 3.1
-122	0.122 / 3.1
-222	0.122 / 3.1
-332	0.122 / 3.1
-472	0.122 / 3.1
-562	0.201 / 5.1
-682	0.201 / 5.1
-822	0.201 / 5.1
-103	0.201 / 5.1
-153	0.201 / 5.1
-223	0.201 / 5.1

* For optional tin-lead and tin-silver-copper terminations, dimensions are for the mounted part. Dimensions before mounting can be an additional 0.005 inch / 0.13 mm.

Packaging

XAL5030 400/7" reel; 1500/13" reel Plastic tape: 16 mm wide, 0.3 mm thick, 12 mm pocket spacing, 3.18 mm pocket depth
XAL5050 250/7" reel; 750/13" reel Plastic tape: 16 mm wide, 0.3 mm thick, 12 mm pocket spacing, 5.21 mm pocket depth

