

Optocoupler, Phototransistor Output, AC Input, with Base Connection

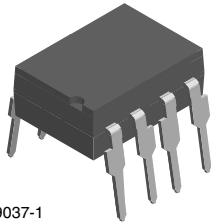

i179037-1

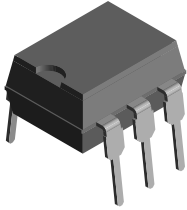
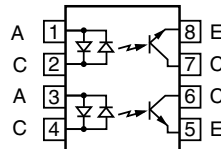
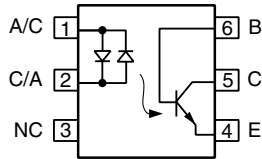

FEATURES

- AC or polarity insensitive inputs
- Built-in reverse polarity input protection
- Improved CTR symmetry
- Industry standard DIP package
- Material categorization: for definitions of compliance please see www.vishay.com/doc?99912

RoHS
COMPLIANT

APPLICATIONS

- Ideal for AC signal detection and monitoring

AGENCY APPROVALS

- UL1577, file no. E52744, double protection
- cUL tested to CSA 22.2 bulletin 5A
- CSA 93751
- BSI EN 60950, BSI EN 60065
- DIN EN 60747-5-5 (VDE 0884-5)
- CQC GB4943.1-2011 and GB8898-2011 (suitable for installation altitude below 2000 m)

DESCRIPTION

The IL250, IL251, IL252, ILD252 are bidirectional input optically coupled isolators consisting of two gallium arsenide infrared LEDs coupled to a silicon NPN phototransistor per channel.

The IL250 has a minimum CTR of 50 %, the IL251 has a minimum CTR of 20 %, and the IL252, ILD252 has a minimum CTR of 100 %.

The IL250, IL251, IL252 are single channel optocouplers. The ILD252 has two isolated channels in a single DIP package.

ORDERING INFORMATION

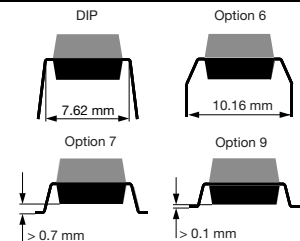
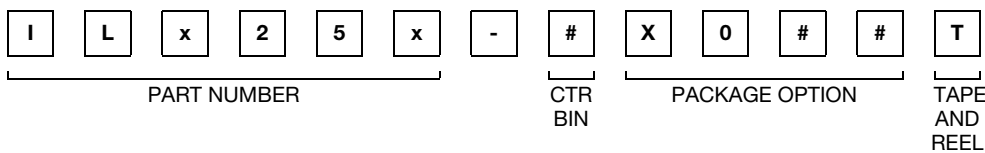

AGENCY CERTIFIED/PACKAGE	CTR (%)			
	SINGLE CHANNEL, 6 PIN			DUAL CHANNEL, 8 PIN
UL, CSA, BSI, CQC	≥ 20	≥ 50	≥ 100	≥ 100
DIP-#	IL251	IL250	IL252	-
SMD-#, option 7	-	IL250-X007	IL252-X007T ⁽¹⁾	-
SMD-#, option 9	IL251-X009T	IL250-X009T ⁽¹⁾	IL252-X009T ⁽¹⁾	-
VDE, UL, CSA, BSI, CQC	≥ 20	≥ 50	≥ 100	≥ 100
DIP-#	-	IL250-X001	IL252-X001	-
DIP-#, option 6	-	-	IL252-X016	-
SMD-#, option 7	-	-	IL252-X017T ⁽¹⁾	ILD252-X017

Notes

- Additional options may be possible, please contact sales office
- ⁽¹⁾ Also available in tubes; do not add "T" to end



ABSOLUTE MAXIMUM RATINGS ($T_{amb} = 25\text{ }^{\circ}\text{C}$, unless otherwise specified)				
PARAMETER	TEST CONDITION	SYMBOL	VALUE	UNIT
INPUT				
Forward continuous current		I_F	60	mA
Power dissipation		P_{diss}	100	mW
Derate linearly from 25 °C			1.33	mW/°C
OUTPUT				
Collector emitter breakdown voltage		BV_{CEO}	30	V
Emitter base breakdown voltage		BV_{EBO}	5	V
Collector base breakdown voltage		BV_{CBO}	70	V
Power dissipation single channel		P_{diss}	200	mW
Power dissipation dual channel		P_{diss}	150	mW
Derate linearly from 25 °C single channel			2.6	mW/°C
Derate linearly from 25 °C dual channel			2	mW/°C
COUPLER				
Total dissipation single channel		P_{tot}	250	mW
Total dissipation dual channel		P_{tot}	400	mW
Derate linearly from 25 °C single channel			3.3	mW/°C
Derate linearly from 25 °C dual channel			5.3	mW/°C
Storage temperature		T_{stg}	-55 to +150	°C
Operating temperature		T_{amb}	-55 to +100	°C
Lead soldering time at 260 °C			10	s

Note

- Stresses in excess of the absolute maximum ratings can cause permanent damage to the device. Functional operation of the device is not implied at these or any other conditions in excess of those given in the operational sections of this document. Exposure to absolute maximum ratings for extended periods of the time can adversely affect reliability

ELECTRICAL CHARACTERISTICS ($T_{amb} = 25\text{ }^{\circ}\text{C}$, unless otherwise specified)						
PARAMETER	TEST CONDITION	SYMBOL	MIN.	TYP.	MAX.	UNIT
INPUT						
Forward voltage	$I_F = \pm 10\text{ mA}$	V_F	-	1.2	1.5	V
OUTPUT						
Collector emitter breakdown voltage	$I_C = 1\text{ mA}$	BV_{CEO}	30	50	-	V
Emitter base breakdown voltage	$I_E = 100\text{ }\mu\text{A}$	BV_{EBO}	7	10	-	V
Collector base breakdown voltage	$I_C = 10\text{ }\mu\text{A}$	BV_{CBO}	70	90	-	V
Collector emitter leakage current	$V_{CE} = 10\text{ V}$	I_{CEO}	-	5	50	nA
COUPLER						
Collector emitter saturation voltage	$I_F = \pm 16\text{ mA}$, $I_C = 2\text{ mA}$	V_{CEsat}	-	-	0.4	V

Note

- Minimum and maximum values are testing requirements. Typical values are characteristics of the device and are the result of engineering evaluation. Typical values are for information only and are not part of the testing requirements



CURRENT TRANSFER RATIO ($T_{amb} = 25\text{ }^{\circ}\text{C}$, unless otherwise specified)							
PARAMETER	TEST CONDITION	PART	SYMBOL	MIN.	TYP.	MAX.	UNIT
I_C/I_F	$I_F = \pm 10\text{ mA}$, $V_{CE} = 10\text{ V}$	IL250	CTR_{DC}	50	-	-	%
		IL251	CTR_{DC}	20	-	-	%
		IL252, ILD252	CTR_{DC}	100	-	-	%
Symmetry	$I_F = \pm 10\text{ mA}$			0.50	1	2	

SWITCHING CHARACTERISTICS ($T_{amb} = 25\text{ }^{\circ}\text{C}$, unless otherwise specified)							
PARAMETER	TEST CONDITION	SYMBOL	MIN.	TYP.	MAX.	UNIT	
Turn-on time		t_{on}	-	TBD	-	μs	
Turn-off time		t_{off}	-	TBD	-	μs	

SAFETY AND INSULATION RATINGS				
PARAMETER	TEST CONDITION	SYMBOL	VALUE	UNIT
Climatic classification	According to IEC 68 part 1		55/100/21	
Comparative tracking index		CTI	175	
Maximum rated withstanding isolation voltage	$t = 1\text{ min}$	V_{ISO}	4420	V_{RMS}
Maximum transient isolation voltage		V_{IOTM}	10 000	V_{peak}
Maximum repetitive peak isolation voltage		V_{IORM}	890	V_{peak}
Isolation resistance	$V_{IO} = 500\text{ V}$, $T_{amb} = 25\text{ }^{\circ}\text{C}$	R_{IO}	$\geq 10^{12}$	Ω
	$V_{IO} = 500\text{ V}$, $T_{amb} = 100\text{ }^{\circ}\text{C}$	R_{IO}	$\geq 10^{11}$	Ω
Output safety power		P_{SO}	400	mW
Input safety current		I_{SI}	275	mA
Safety temperature		T_S	175	$^{\circ}\text{C}$
Creepage distance			≥ 7	mm
Clearance distance			≥ 7	mm
Insulation thickness		DTI	≥ 0.4	mm

Note

- As per IEC 60747-5-5, § 7.4.3.8.2, this optocoupler is suitable for “safe electrical insulation” only within the safety ratings. Compliance with the safety ratings shall be ensured by means of protective circuits



TYPICAL CHARACTERISTICS (T_{amb} = 25 °C, unless otherwise specified)

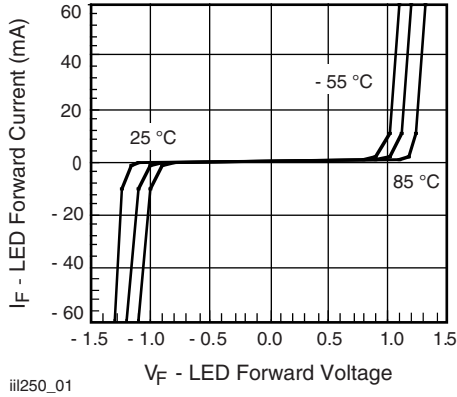

Fig. 1 - LED Forward Current vs. Forward Voltage

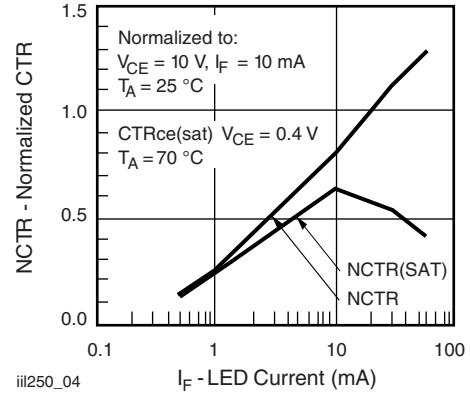

Fig. 4 - Normalized Non-Saturated and Saturated CTR vs. LED Current

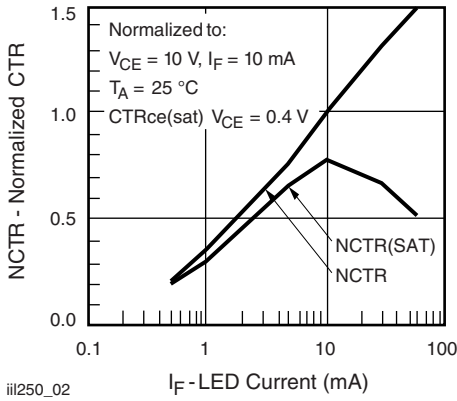

Fig. 2 - Normalized Non-Saturated and Saturated CTR vs. LED Current

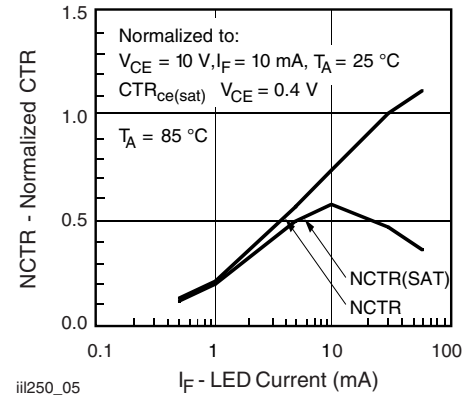

Fig. 5 - Normalized Non-Saturated and Saturated CTR vs. LED Current

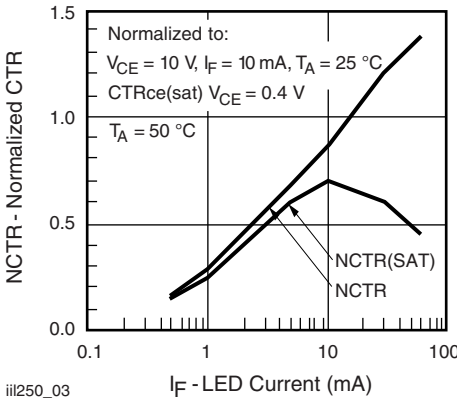

Fig. 3 - Normalized Non-Saturated and Saturated CTR vs. LED Current

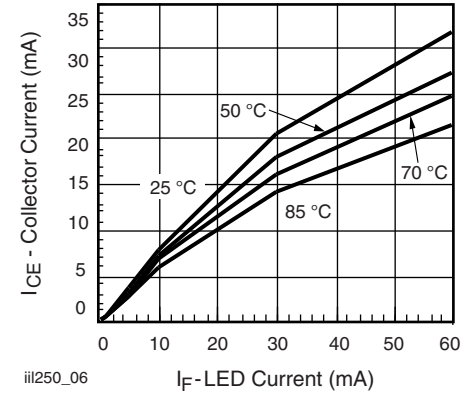

Fig. 6 - Collector Emitter Current vs. Temperature and LED Current

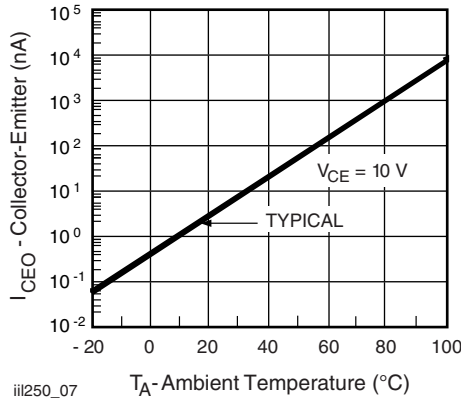

Fig. 7 - Collector Emitter Leakage Current vs. Temperature

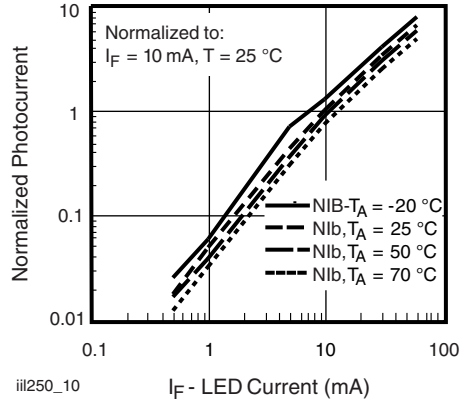

Fig. 10 - Normalized Photocurrent vs. I_F and Temperature

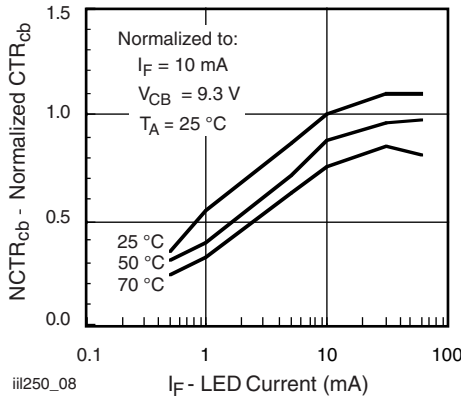

Fig. 8 - Normalized CTR_{CB} vs. LED Current and Temperature

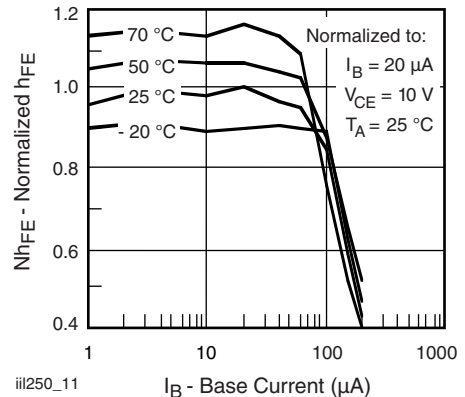

Fig. 11 - Normalized Non Saturated h_{FE} vs. Base Current and Temperature

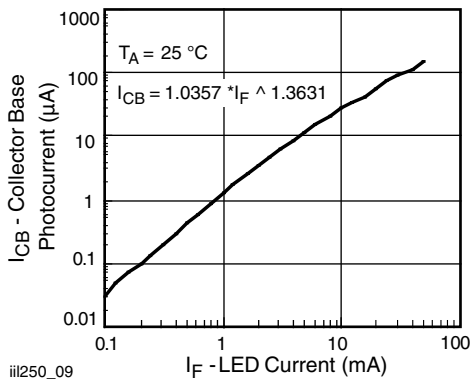

Fig. 9 - Collector Base Photocurrent vs. LED Current

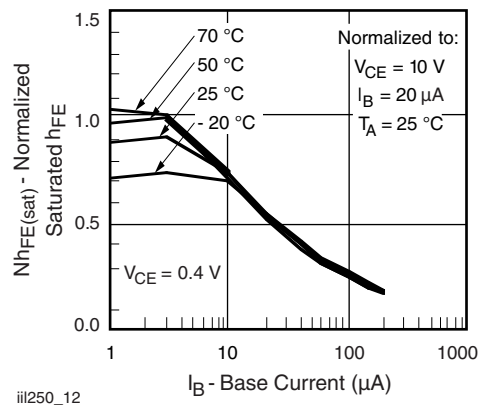

Fig. 12 - Normalized Saturated h_{FE} vs. Base Current and Temperature

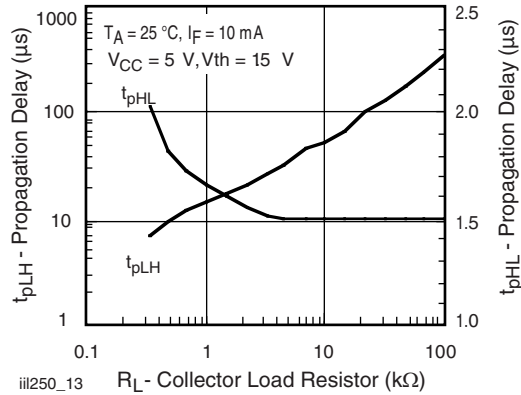

Fig. 13 - Propagation Delay vs. Collector Load Resistor

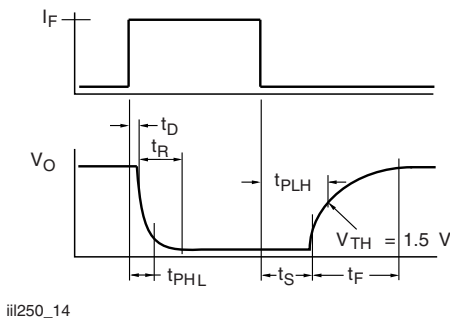

Fig. 14 - Switching Timing

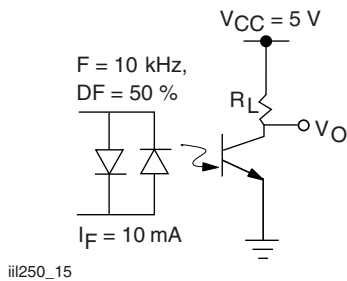
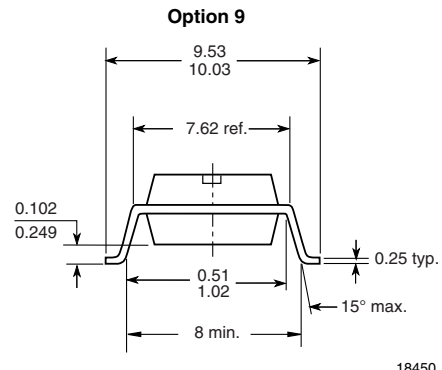
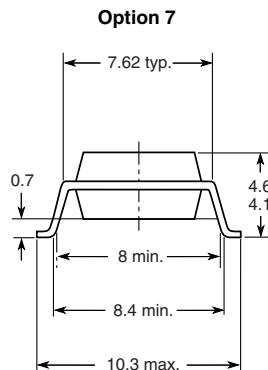
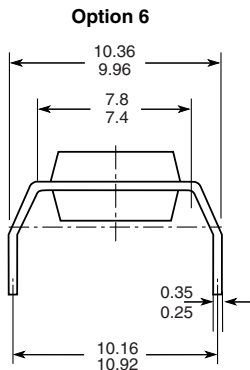
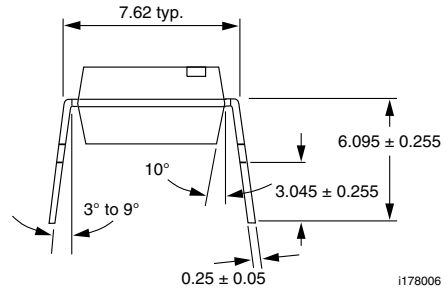
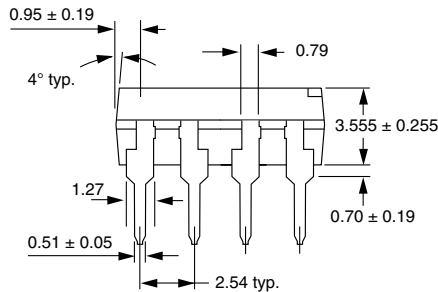
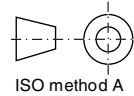
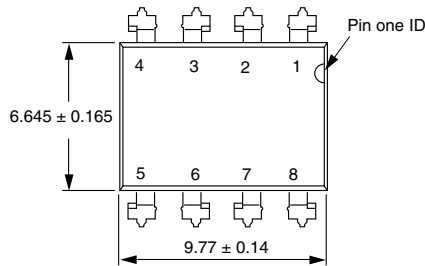
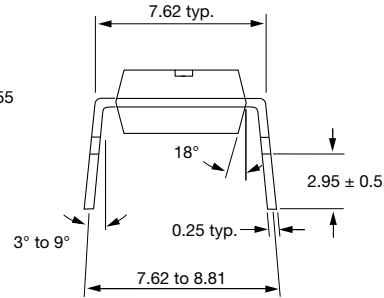
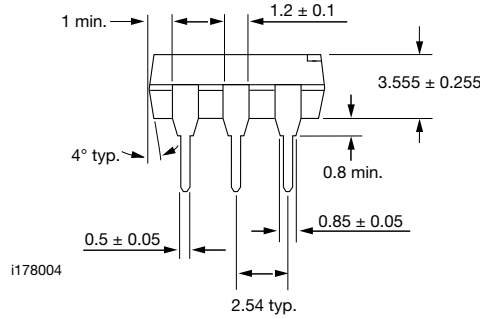
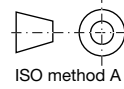
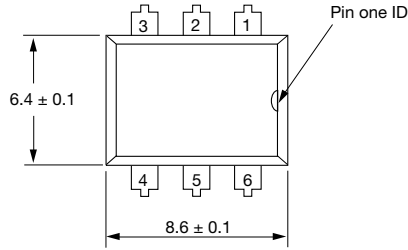

Fig. 15 - Switching Schematic



PACKAGE DIMENSIONS in inches (millimeters)





Disclaimer

ALL PRODUCT, PRODUCT SPECIFICATIONS AND DATA ARE SUBJECT TO CHANGE WITHOUT NOTICE TO IMPROVE RELIABILITY, FUNCTION OR DESIGN OR OTHERWISE.

Vishay Intertechnology, Inc., its affiliates, agents, and employees, and all persons acting on its or their behalf (collectively, "Vishay"), disclaim any and all liability for any errors, inaccuracies or incompleteness contained in any datasheet or in any other disclosure relating to any product.

Vishay makes no warranty, representation or guarantee regarding the suitability of the products for any particular purpose or the continuing production of any product. To the maximum extent permitted by applicable law, Vishay disclaims (i) any and all liability arising out of the application or use of any product, (ii) any and all liability, including without limitation special, consequential or incidental damages, and (iii) any and all implied warranties, including warranties of fitness for particular purpose, non-infringement and merchantability.

Statements regarding the suitability of products for certain types of applications are based on Vishay's knowledge of typical requirements that are often placed on Vishay products in generic applications. Such statements are not binding statements about the suitability of products for a particular application. It is the customer's responsibility to validate that a particular product with the properties described in the product specification is suitable for use in a particular application. Parameters provided in datasheets and / or specifications may vary in different applications and performance may vary over time. All operating parameters, including typical parameters, must be validated for each customer application by the customer's technical experts. Product specifications do not expand or otherwise modify Vishay's terms and conditions of purchase, including but not limited to the warranty expressed therein.

Except as expressly indicated in writing, Vishay products are not designed for use in medical, life-saving, or life-sustaining applications or for any other application in which the failure of the Vishay product could result in personal injury or death. Customers using or selling Vishay products not expressly indicated for use in such applications do so at their own risk. Please contact authorized Vishay personnel to obtain written terms and conditions regarding products designed for such applications.

No license, express or implied, by estoppel or otherwise, to any intellectual property rights is granted by this document or by any conduct of Vishay. Product names and markings noted herein may be trademarks of their respective owners.