

# 74VHC125; 74VHCT125

Quad buffer/line driver; 3-state

Rev. 02 — 13 October 2009

Product data sheet

## 1. General description

The 74VHC125; 74VHCT125 are high-speed Si-gate CMOS devices and are pin compatible with Low-power Schottky TTL (LSTTL). They are specified in compliance with JEDEC standard JESD7-A.

The 74VHC125; 74VHCT125 provides four non-inverting buffer/line drivers with 3-state outputs. The 3-state outputs (nY) are controlled by the output enable input ( $\overline{nOE}$ ). A HIGH at  $\overline{nOE}$  causes the outputs to assume a high-impedance OFF-state.

The 74VHC125; 74VHCT125 are identical to the 74VHC126; 74VHCT126 but have active LOW enable inputs.

## 2. Features

- Balanced propagation delays
- All inputs have a Schmitt-trigger action
- Inputs accepts voltages higher than  $V_{CC}$
- Input levels:
  - ◆ The 74VHC125 operates with CMOS logic levels
  - ◆ The 74VHCT125 operates with TTL logic levels
- ESD protection:
  - ◆ HBM JESD22-A114E exceeds 2000 V
  - ◆ MM JESD22-A115-A exceeds 200 V
  - ◆ CDM JESD22-C101C exceeds 1000 V
- Multiple package options
- Specified from  $-40\text{ }^{\circ}\text{C}$  to  $+85\text{ }^{\circ}\text{C}$  and from  $-40\text{ }^{\circ}\text{C}$  to  $+125\text{ }^{\circ}\text{C}$

## 3. Ordering information

Table 1. Ordering information

Type number	Package			Version
	Temperature range	Name	Description	
74VHC125D 74VHCT125D	$-40\text{ }^{\circ}\text{C}$ to $+125\text{ }^{\circ}\text{C}$	SO14	plastic small outline package; 14 leads; body width 3.9 mm	SOT108-1
74VHC125PW 74VHCT125PW	$-40\text{ }^{\circ}\text{C}$ to $+125\text{ }^{\circ}\text{C}$	TSSOP14	plastic thin shrink small outline package; 14 leads; body width 4.4 mm	SOT402-1
74VHC125BQ 74VHCT125BQ	$-40\text{ }^{\circ}\text{C}$ to $+125\text{ }^{\circ}\text{C}$	DHVQFN14	plastic dual in-line compatible thermal enhanced very thin quad flat package; no leads; 14 terminals; body $2.5 \times 3 \times 0.85$ mm	SOT762-1

## 4. Functional diagram

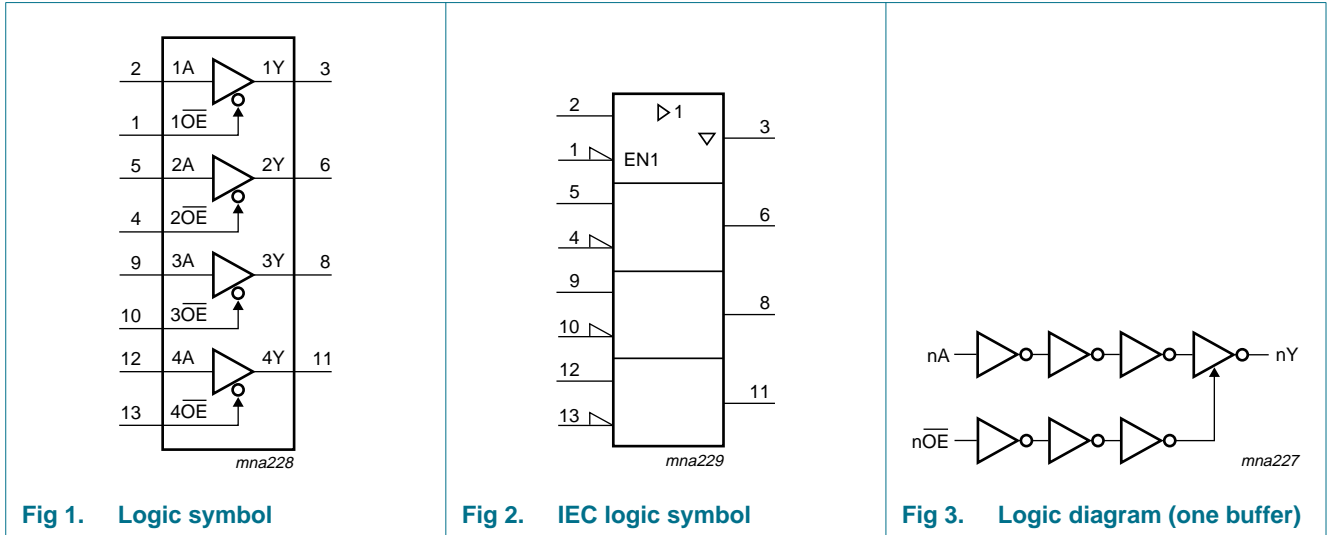

## 5. Pinning information

### 5.1 Pinning

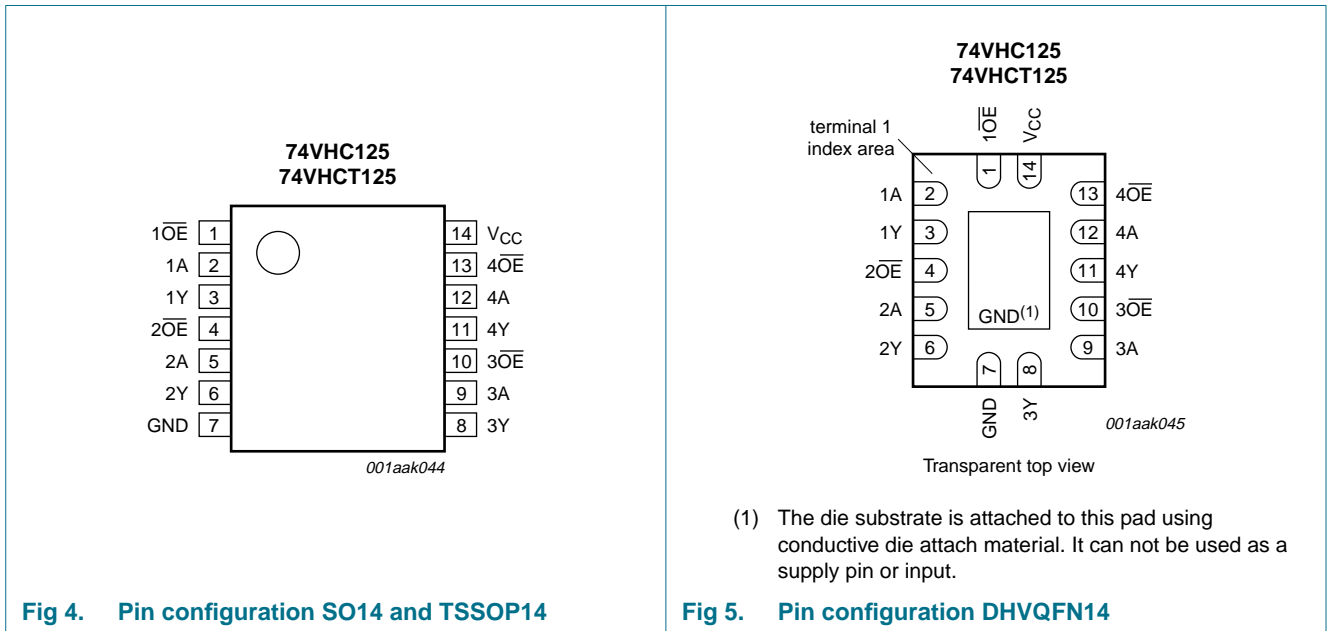

## 5.2 Pin description

**Table 2.** Pin description

Symbol	Pin	Description
$1\overline{OE}$ , $2\overline{OE}$ , $3\overline{OE}$ , $4\overline{OE}$	1, 4, 10, 13	output enable input (active LOW)
1A, 2A, 3A, 4A	2, 5, 9, 12	data input
1Y, 2Y, 3Y, 4Y	3, 6, 8, 11	data output
GND	7	ground (0 V)
$V_{CC}$	14	supply voltage

## 6. Functional description

**Table 3.** Function table<sup>[1]</sup>

Control	Input	Output
$n\overline{OE}$	nA	nY
L	L	L
	H	H
H	X	Z

[1] H = HIGH voltage level; L = LOW voltage level; X = don't care; Z = high-impedance OFF-state.

## 7. Limiting values

**Table 4.** Limiting values

In accordance with the Absolute Maximum Rating System (IEC 60134). Voltages are referenced to GND (ground = 0 V).

Symbol	Parameter	Conditions	Min	Max	Unit
$V_{CC}$	supply voltage		-0.5	+7.0	V
$V_I$	input voltage		-0.5	+7.0	V
$I_{IK}$	input clamping current	$V_I < -0.5$ V	[1] -20	-	mA
$I_{OK}$	output clamping current	$V_O < -0.5$ V or $V_O > V_{CC} + 0.5$ V	[1] -	±20	mA
$I_O$	output current	$V_O = -0.5$ V to $(V_{CC} + 0.5$ V)	-	±25	mA
$I_{CC}$	supply current		-	75	mA
$I_{GND}$	ground current		-75	-	mA
$T_{stg}$	storage temperature		-65	+150	°C
$P_{tot}$	total power dissipation	$T_{amb} = -40$ °C to +125 °C			
	SO14 package		[2] -	500	mW
	TSSOP14 package		[3] -	500	mW
	DHVQFN14 package		[4] -	500	mW

[1] The input and output voltage ratings may be exceeded if the input and output current ratings are observed.

[2]  $P_{tot}$  derates linearly with 8 mW/K above 70 °C.

[3]  $P_{tot}$  derates linearly with 5.5 mW/K above 60 °C.

[4]  $P_{tot}$  derates linearly with 4.5 mW/K above 60 °C.

## 8. Recommended operating conditions

**Table 5. Recommended operating conditions**

Voltages are referenced to GND (ground = 0 V).

Symbol	Parameter	Conditions	74VHC125			74VHCT125			Unit
			Min	Typ	Max	Min	Typ	Max	
V <sub>CC</sub>	supply voltage		2.0	5.0	5.5	4.5	5.0	5.5	V
V <sub>I</sub>	input voltage		0	-	5.5	0	-	5.5	V
V <sub>O</sub>	output voltage		0	-	V <sub>CC</sub>	0	-	V <sub>CC</sub>	V
T <sub>amb</sub>	ambient temperature		-40	+25	+125	-40	+25	+125	°C
Δt/ΔV	input transition rise and fall rate	V <sub>CC</sub> = 3.3 V ± 0.3 V	-	-	100	-	-	-	ns/V
		V <sub>CC</sub> = 5.0 V ± 0.5 V	-	-	20	-	-	20	ns/V

## 9. Static characteristics

**Table 6. Static characteristics**

Voltages are referenced to GND (ground = 0 V).

Symbol	Parameter	Conditions	25 °C			-40 °C to +85 °C		-40 °C to +125 °C		Unit
			Min	Typ	Max	Min	Max	Min	Max	
<b>For type 74VHC125</b>										
V <sub>IH</sub>	HIGH-level input voltage	V <sub>CC</sub> = 2.0 V	1.5	-	-	1.5	-	1.5	-	V
		V <sub>CC</sub> = 3.0 V	2.1	-	-	2.1	-	2.1	-	V
		V <sub>CC</sub> = 5.5 V	3.85	-	-	3.85	-	3.85	-	V
V <sub>IL</sub>	LOW-level input voltage	V <sub>CC</sub> = 2.0 V	-	-	0.5	-	0.5	-	0.5	V
		V <sub>CC</sub> = 3.0 V	-	-	0.9	-	0.9	-	0.9	V
		V <sub>CC</sub> = 5.5 V	-	-	1.65	-	1.65	-	1.65	V
V <sub>OH</sub>	HIGH-level output voltage	V <sub>I</sub> = V <sub>IH</sub> or V <sub>IL</sub>								
		I <sub>O</sub> = -50 μA; V <sub>CC</sub> = 2.0 V	1.9	2.0	-	1.9	-	1.9	-	V
		I <sub>O</sub> = -50 μA; V <sub>CC</sub> = 3.0 V	2.9	3.0	-	2.9	-	2.9	-	V
		I <sub>O</sub> = -50 μA; V <sub>CC</sub> = 4.5 V	4.4	4.5	-	4.4	-	4.4	-	V
		I <sub>O</sub> = -4.0 mA; V <sub>CC</sub> = 3.0 V	2.58	-	-	2.48	-	2.40	-	V
I <sub>O</sub> = -8.0 mA; V <sub>CC</sub> = 4.5 V	3.94	-	-	3.8	-	3.70	-	V		
V <sub>OL</sub>	LOW-level output voltage	V <sub>I</sub> = V <sub>IH</sub> or V <sub>IL</sub>								
		I <sub>O</sub> = 50 μA; V <sub>CC</sub> = 2.0 V	-	0	0.1	-	0.1	-	0.1	V
		I <sub>O</sub> = 50 μA; V <sub>CC</sub> = 3.0 V	-	0	0.1	-	0.1	-	0.1	V
		I <sub>O</sub> = 50 μA; V <sub>CC</sub> = 4.5 V	-	0	0.1	-	0.1	-	0.1	V
		I <sub>O</sub> = 4.0 mA; V <sub>CC</sub> = 3.0 V	-	-	0.36	-	0.44	-	0.55	V
I <sub>O</sub> = 8.0 mA; V <sub>CC</sub> = 4.5 V	-	-	0.36	-	0.44	-	0.55	V		
I <sub>OZ</sub>	OFF-state output current	V <sub>I</sub> = V <sub>IH</sub> or V <sub>IL</sub> ; V <sub>O</sub> = V <sub>CC</sub> or GND; V <sub>CC</sub> = 5.5 V	-	-	±0.25	-	±2.5	-	±10.0	μA
I <sub>I</sub>	input leakage current	V <sub>I</sub> = 5.5 V or GND; V <sub>CC</sub> = 0 V to 5.5 V	-	-	0.1	-	1.0	-	2.0	μA
I <sub>CC</sub>	supply current	V <sub>I</sub> = V <sub>CC</sub> or GND; I <sub>O</sub> = 0 A; V <sub>CC</sub> = 5.5 V	-	-	2.0	-	20	-	40	μA

**Table 6. Static characteristics ...continued**  
 Voltages are referenced to GND (ground = 0 V).

Symbol	Parameter	Conditions	25 °C			-40 °C to +85 °C		-40 °C to +125 °C		Unit
			Min	Typ	Max	Min	Max	Min	Max	
C <sub>I</sub>	input capacitance		-	3.0	10	-	10	-	10	pF
C <sub>O</sub>	output capacitance		-	4.0	-	-	-	-	-	pF
<b>For type 74VHCT125</b>										
V <sub>IH</sub>	HIGH-level input voltage	V <sub>CC</sub> = 4.5 V to 5.5 V	2.0	-	-	2.0	-	2.0	-	V
V <sub>IL</sub>	LOW-level input voltage	V <sub>CC</sub> = 4.5 V to 5.5 V	-	-	0.8	-	0.8	-	0.8	V
V <sub>OH</sub>	HIGH-level output voltage	V <sub>I</sub> = V <sub>IH</sub> or V <sub>IL</sub> ; V <sub>CC</sub> = 4.5 V								
		I <sub>O</sub> = -50 μA	4.4	4.5	-	4.4	-	4.4	-	V
		I <sub>O</sub> = -8.0 mA	3.94	-	-	3.8	-	3.70	-	V
V <sub>OL</sub>	LOW-level output voltage	V <sub>I</sub> = V <sub>IH</sub> or V <sub>IL</sub> ; V <sub>CC</sub> = 4.5 V								
		I <sub>O</sub> = 50 μA	-	0	0.1	-	0.1	-	0.1	V
		I <sub>O</sub> = 8.0 mA	-	-	0.36	-	0.44	-	0.55	V
I <sub>OZ</sub>	OFF-state output current	per input pin; V <sub>I</sub> = V <sub>IH</sub> or V <sub>IL</sub> ; V <sub>CC</sub> = 5.5 V; I <sub>O</sub> = 0 A V <sub>O</sub> = V <sub>CC</sub> or GND; other pins at V <sub>CC</sub> or GND	-	-	±0.25	-	±2.5	-	±10.0	μA
I <sub>I</sub>	input leakage current	V <sub>I</sub> = 5.5 V or GND; V <sub>CC</sub> = 0 V to 5.5 V	-	-	0.1	-	1.0	-	2.0	μA
I <sub>CC</sub>	supply current	V <sub>I</sub> = V <sub>CC</sub> or GND; I <sub>O</sub> = 0 A; V <sub>CC</sub> = 5.5 V	-	-	2.0	-	20	-	40	μA
ΔI <sub>CC</sub>	additional supply current	per input pin; V <sub>I</sub> = V <sub>CC</sub> - 2.1 V; I <sub>O</sub> = 0 A; other pins at V <sub>CC</sub> or GND; V <sub>CC</sub> = 4.5 V to 5.5 V	-	-	1.35	-	1.5	-	1.5	mA
C <sub>I</sub>	input capacitance		-	3.0	10	-	10	-	10	pF
C <sub>O</sub>	output capacitance		-	4.0	-	-	-	-	-	pF

## 10. Dynamic characteristics

**Table 7. Dynamic characteristics**  
*GND = 0 V; For test circuit see Figure 8.*

Symbol	Parameter	Conditions	25 °C			−40 °C to +85 °C		−40 °C to +125 °C		Unit
			Min	Typ <sup>[1]</sup>	Max	Min	Max	Min	Max	
<b>For type 74VHC125</b>										
$t_{pd}$	propagation delay	nA to nY; see Figure 6 <sup>[2]</sup>								
		$V_{CC} = 3.0\text{ V to }3.6\text{ V}$								
		$C_L = 15\text{ pF}$	-	4.4	8.0	1.0	9.5	1.0	11.5	ns
		$C_L = 50\text{ pF}$	-	6.2	11.5	1.0	13.0	1.0	14.5	ns
		$V_{CC} = 4.5\text{ V to }5.5\text{ V}$								
		$C_L = 15\text{ pF}$	-	3.0	5.5	1.0	6.5	1.0	7.0	ns
$t_{en}$	enable time	nOE to nY; see Figure 7 <sup>[2]</sup>								
		$V_{CC} = 3.0\text{ V to }3.6\text{ V}$								
		$C_L = 15\text{ pF}$	-	4.7	8.0	1.0	9.5	1.0	11.5	ns
		$C_L = 50\text{ pF}$	-	6.8	11.5	1.0	13.0	1.0	14.5	ns
		$V_{CC} = 4.5\text{ V to }5.5\text{ V}$								
		$C_L = 15\text{ pF}$	-	3.3	5.1	1.0	6.0	1.0	6.5	ns
$t_{dis}$	disable time	nOE to nY; see Figure 7 <sup>[2]</sup>								
		$V_{CC} = 3.0\text{ V to }3.6\text{ V}$								
		$C_L = 15\text{ pF}$	-	6.7	9.7	1.0	11.5	1.0	12.5	ns
		$C_L = 50\text{ pF}$	-	9.6	13.2	1.0	15.0	1.0	16.5	ns
		$V_{CC} = 4.5\text{ V to }5.5\text{ V}$								
		$C_L = 15\text{ pF}$	-	4.8	6.8	1.0	8.0	1.0	8.5	ns
$C_{PD}$	power dissipation capacitance	$C_L = 50\text{ pF}; f_i = 1\text{ MHz}; V_i = \text{GND to }V_{CC}$ <sup>[3]</sup>	-	10	-	-	-	-	-	pF

**Table 7. Dynamic characteristics ...continued**  
*GND = 0 V; For test circuit see Figure 8.*

Symbol	Parameter	Conditions	25 °C			-40 °C to +85 °C		-40 °C to +125 °C		Unit
			Min	Typ <sup>[1]</sup>	Max	Min	Max	Min	Max	
<b>For type 74VHCT125</b>										
t <sub>pd</sub>	propagation delay	nA to nY; see Figure 6 <sup>[2]</sup>								
		V <sub>CC</sub> = 4.5 V to 5.5 V								
		C <sub>L</sub> = 15 pF	-	3.0	5.5	1.0	6.5	1.0	7.0	ns
		C <sub>L</sub> = 50 pF	-	4.3	7.5	1.0	8.5	1.0	9.5	ns
t <sub>en</sub>	enable time	nOE to nY; see Figure 7								
		V <sub>CC</sub> = 4.5 V to 5.5 V								
		C <sub>L</sub> = 15 pF	-	3.4	5.1	1.0	6.0	1.0	6.5	ns
		C <sub>L</sub> = 50 pF	-	4.9	7.3	1.0	8.3	1.0	9.5	ns
t <sub>dis</sub>	disable time	nOE to nY; see Figure 7 <sup>[2]</sup>								
		V <sub>CC</sub> = 4.5 V to 5.5 V								
		C <sub>L</sub> = 15 pF	-	4.5	6.8	1.0	8.0	1.0	8.5	ns
		C <sub>L</sub> = 50 pF	-	6.5	8.8	1.0	10.0	1.0	11.0	ns
C <sub>PD</sub>	power dissipation capacitance	C <sub>L</sub> = 50 pF; f <sub>i</sub> = 1 MHz; V <sub>i</sub> = GND to V <sub>CC</sub> <sup>[3]</sup>	-	12	-	-	-	-	-	pF

[1] Typical values are measured at nominal supply voltage (V<sub>CC</sub> = 3.3 V and V<sub>CC</sub> = 5.0 V).

[2] t<sub>pd</sub> is the same as t<sub>PLH</sub> and t<sub>PHL</sub>.  
 t<sub>en</sub> is the same as t<sub>PZL</sub> and t<sub>PZH</sub>.  
 t<sub>dis</sub> is the same as t<sub>PLZ</sub> and t<sub>PHZ</sub>.

[3] C<sub>PD</sub> is used to determine the dynamic power dissipation (P<sub>D</sub> in μW).  
 $P_D = C_{PD} \times V_{CC}^2 \times f_i \times N + \Sigma(C_L \times V_{CC}^2 \times f_o)$  where:  
 f<sub>i</sub> = input frequency in MHz, f<sub>o</sub> = output frequency in MHz  
 C<sub>L</sub> = output load capacitance in pF  
 V<sub>CC</sub> = supply voltage in Volts  
 N = number of inputs switching  
 $\Sigma(C_L \times V_{CC}^2 \times f_o)$  = sum of the outputs.

## 11. Waveforms

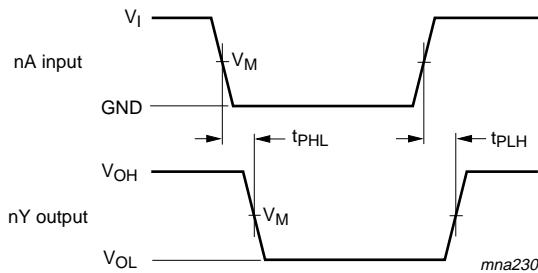

Measurement points are given in Table 8.  
 V<sub>OL</sub> and V<sub>OH</sub> are typical voltage output levels that occur with the output load.

**Fig. 6. Propagation delay input (nA) to output (nY)**

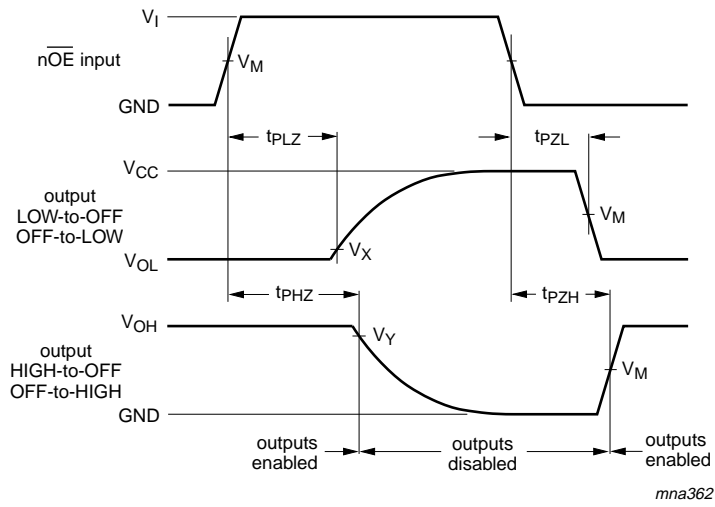

Measurement points are given in [Table 8](#).

$V_{OL}$  and  $V_{OH}$  are typical voltage output levels that occur with the output load.

**Fig 7. Enable and disable times**

**Table 8. Measurement points**

Type	Input	Output		
	$V_M$	$V_M$	$V_X$	$V_Y$
74VHC125	$0.5V_{CC}$	$0.5V_{CC}$	$V_{OL} + 0.3 V$	$V_{OL} - 0.3 V$
74VHCT125	1.5 V	$0.5V_{CC}$	$V_{OL} + 0.3 V$	$V_{OL} - 0.3 V$



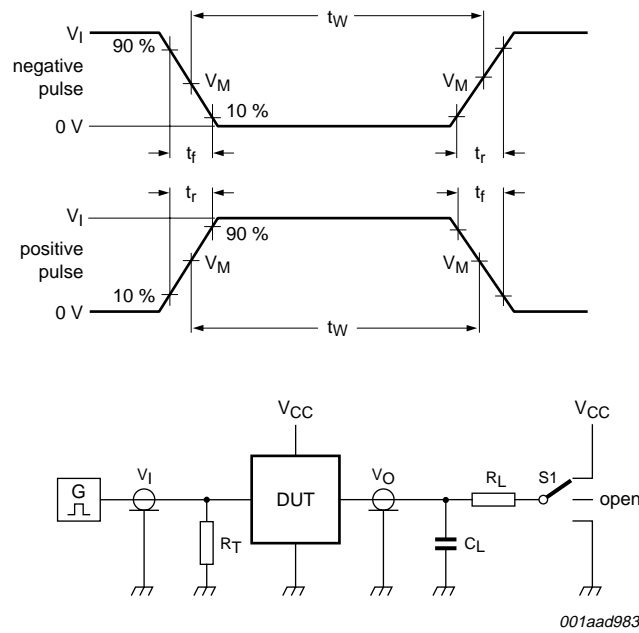

Test data is given in [Table 9](#).

Definitions test circuit:

$R_T$  = Termination resistance should be equal to output impedance  $Z_o$  of the pulse generator.

$C_L$  = Load capacitance including jig and probe capacitance.

$R_L$  = Load resistance.

$S1$  = Test selection switch.

**Fig 8. Load circuit for switching times**

**Table 9. Test data**

Type	Input		Load		S1 position		
	$V_I$	$t_r, t_f$	$C_L$	$R_L$	$t_{PHL}, t_{PLH}$	$t_{PZH}, t_{PHZ}$	$t_{PZL}, t_{PLZ}$
74VHC125	$V_{CC}$	$\leq 3.0$ ns	15 pF, 50 pF	1 k $\Omega$	open	GND	$V_{CC}$
74VHCT125	3.0 V	$\leq 3.0$ ns	15 pF, 50 pF	1 k $\Omega$	open	GND	$V_{CC}$

12. Package outline

SO14: plastic small outline package; 14 leads; body width 3.9 mm

SOT108-1

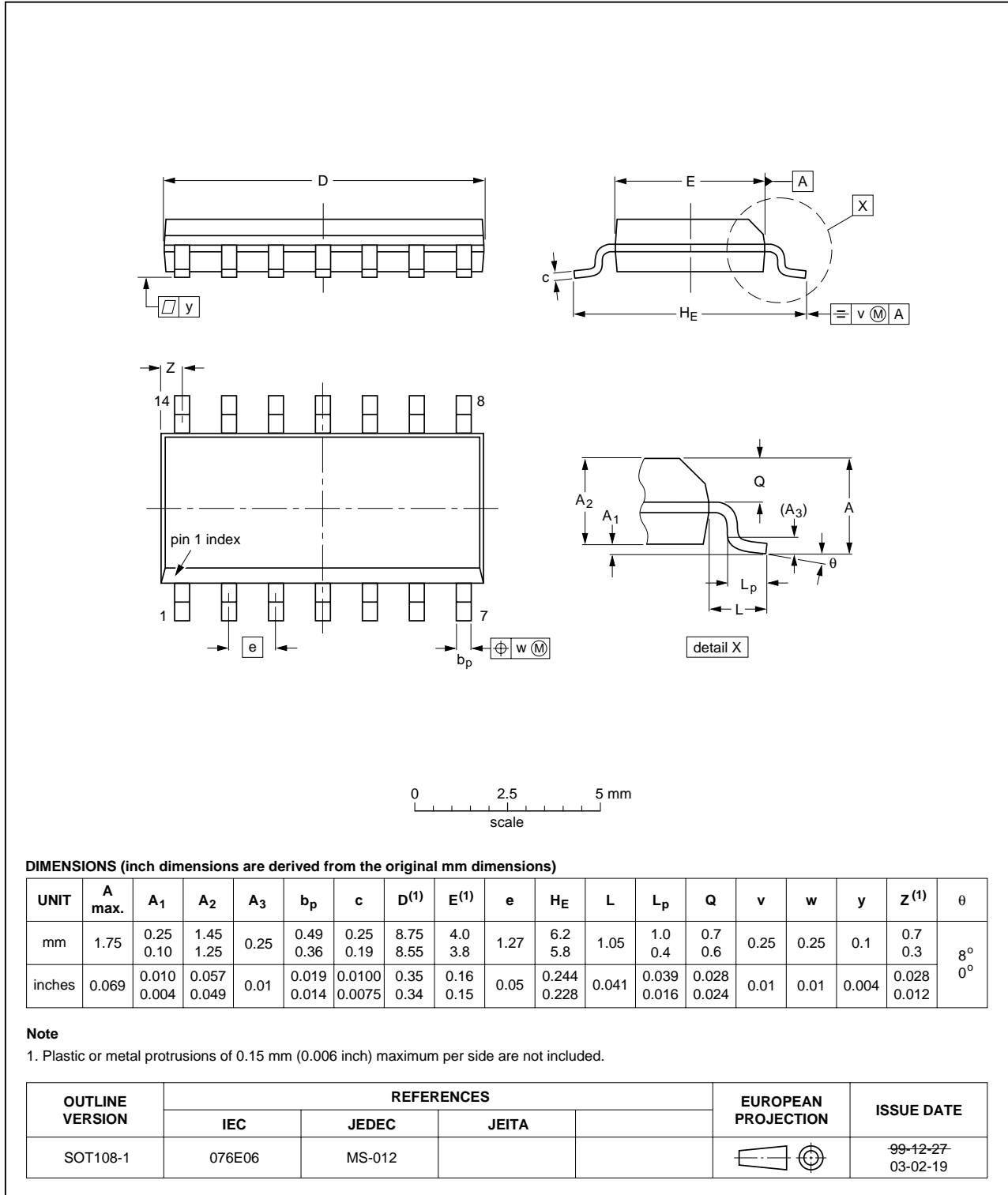

Fig 9. Package outline SOT108-1 (SO14)

TSSOP14: plastic thin shrink small outline package; 14 leads; body width 4.4 mm

SOT402-1

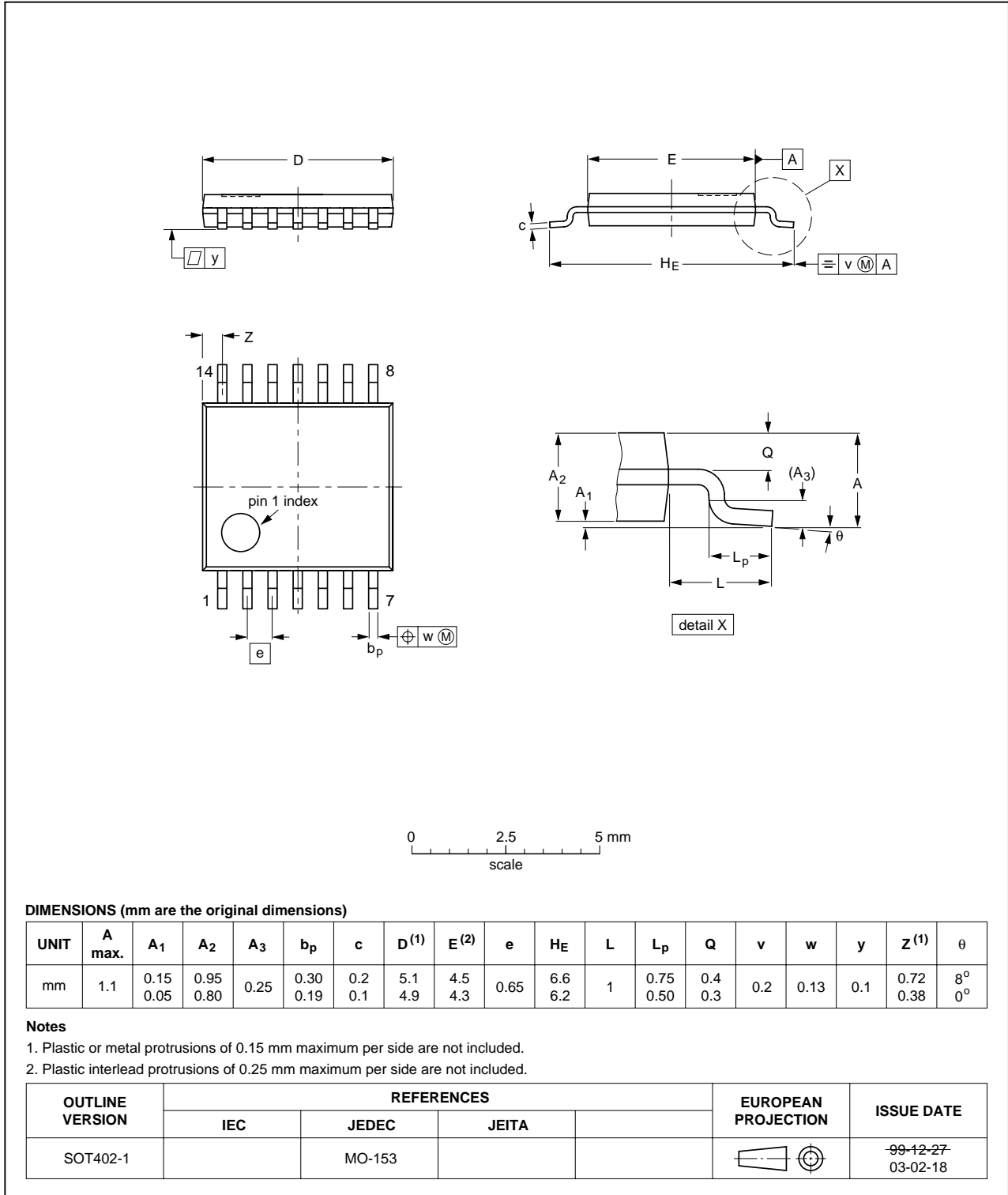
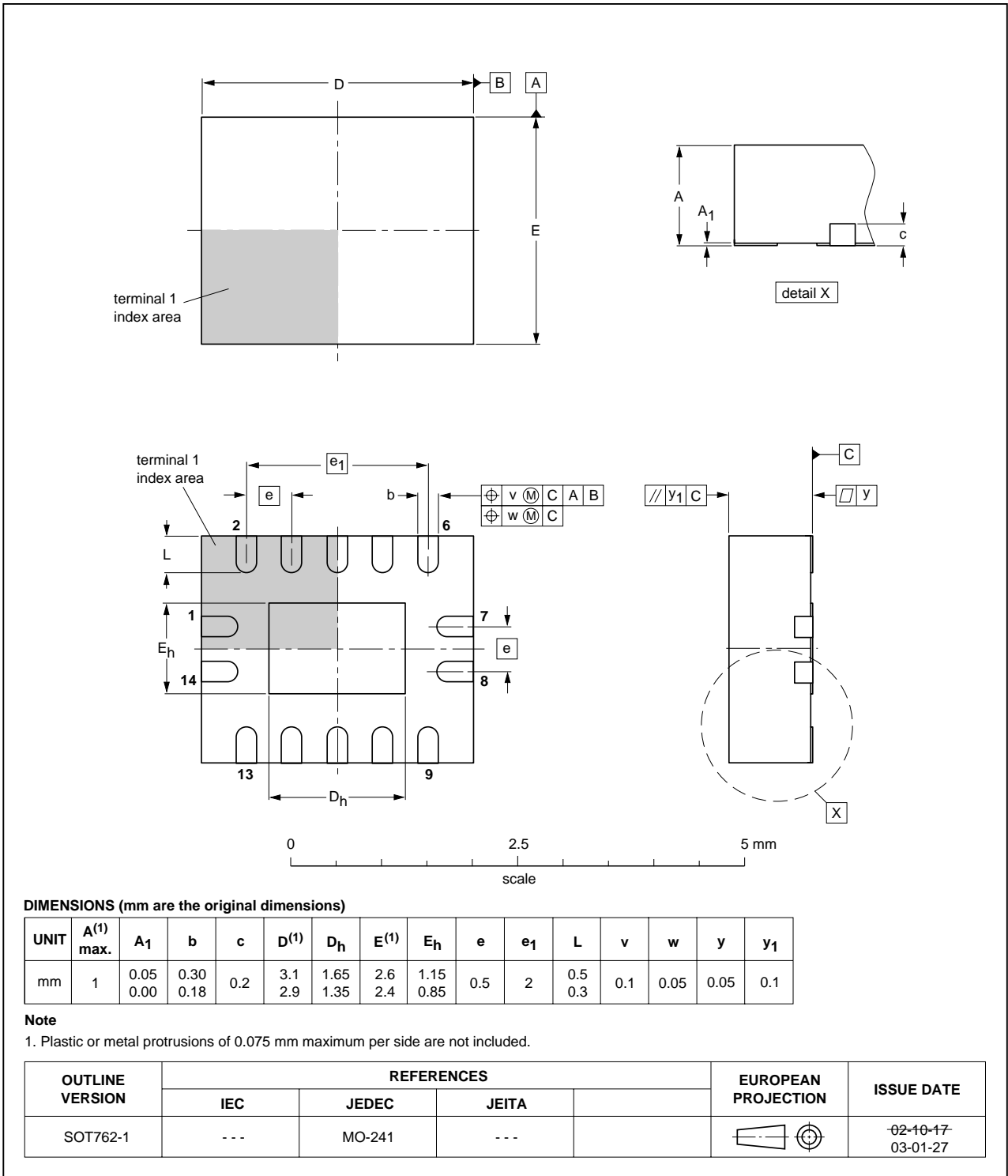

Fig 10. Package outline SOT402-1 (TSSOP14)

**DHVQFN14: plastic dual in-line compatible thermal enhanced very thin quad flat package; no leads; 14 terminals; body 2.5 x 3 x 0.85 mm**

**SOT762-1**



**Fig 11. Package outline SOT762-1 (DHVQFN14)**

## 13. Abbreviations

Table 10. Abbreviations

Acronym	Description
CMOS	Complementary Metal Oxide Semiconductor
LSTTL	Low-power Schottky Transistor-Transistor Logic
ESD	ElectroStatic Discharge
HBM	Human Body Model
MM	Machine Model
CDM	Charge-Device Model
TTL	Transistor-Transistor Logic

## 14. Revision history

Table 11. Revision history

Document ID	Release date	Data sheet status	Change notice	Supersedes
74VHC_VHCT125_2	20091013	Product data sheet	-	74VHC_VHCT125_1
Modifications:	• Errata in features list corrected.			
74VHC_VHCT125_1	20090630	Product data sheet	-	-

## 15. Legal information

### 15.1 Data sheet status

Document status <sup>[1][2]</sup>	Product status <sup>[3]</sup>	Definition
Objective [short] data sheet	Development	This document contains data from the objective specification for product development.
Preliminary [short] data sheet	Qualification	This document contains data from the preliminary specification.
Product [short] data sheet	Production	This document contains the product specification.

[1] Please consult the most recently issued document before initiating or completing a design.

[2] The term 'short data sheet' is explained in section "Definitions".

[3] The product status of device(s) described in this document may have changed since this document was published and may differ in case of multiple devices. The latest product status information is available on the Internet at URL <http://www.nexperia.com>.

### 15.2 Definitions

**Draft** — The document is a draft version only. The content is still under internal review and subject to formal approval, which may result in modifications or additions. Nexperia does not give any representations or warranties as to the accuracy or completeness of information included herein and shall have no liability for the consequences of use of such information.

**Short data sheet** — A short data sheet is an extract from a full data sheet with the same product type number(s) and title. A short data sheet is intended for quick reference only and should not be relied upon to contain detailed and full information. For detailed and full information see the relevant full data sheet, which is available on request via the local Nexperia sales office. In case of any inconsistency or conflict with the short data sheet, the full data sheet shall prevail.

### 15.3 Disclaimers

**General** — Information in this document is believed to be accurate and reliable. However, Nexperia does not give any representations or warranties, expressed or implied, as to the accuracy or completeness of such information and shall have no liability for the consequences of use of such information.

**Right to make changes** — Nexperia reserves the right to make changes to information published in this document, including without limitation specifications and product descriptions, at any time and without notice. This document supersedes and replaces all information supplied prior to the publication hereof.

**Suitability for use** — Nexperia products are not designed, authorized or warranted to be suitable for use in medical, military, aircraft, space or life support equipment, nor in applications where failure or malfunction of a Nexperia product can reasonably be expected to result in personal injury, death or severe property or environmental

damage. Nexperia accepts no liability for inclusion and/or use of Nexperia products in such equipment or applications and therefore such inclusion and/or use is at the customer's own risk.

**Applications** — Applications that are described herein for any of these products are for illustrative purposes only. Nexperia makes no representation or warranty that such applications will be suitable for the specified use without further testing or modification.

**Limiting values** — Stress above one or more limiting values (as defined in the Absolute Maximum Ratings System of IEC 60134) may cause permanent damage to the device. Limiting values are stress ratings only and operation of the device at these or any other conditions above those given in the Characteristics sections of this document is not implied. Exposure to limiting values for extended periods may affect device reliability.

**Terms and conditions of sale** — Nexperia products are sold subject to the general terms and conditions of commercial sale, as published at <http://www.nexperia.com/profile/terms>, including those pertaining to warranty, intellectual property rights infringement and limitation of liability, unless explicitly otherwise agreed to in writing by Nexperia. In case of any inconsistency or conflict between information in this document and such terms and conditions, the latter will prevail.

**No offer to sell or license** — Nothing in this document may be interpreted or construed as an offer to sell products that is open for acceptance or the grant, conveyance or implication of any license under any copyrights, patents or other industrial or intellectual property rights.

**Export control** — This document as well as the item(s) described herein may be subject to export control regulations. Export might require a prior authorization from national authorities.

### 15.4 Trademarks

Notice: All referenced brands, product names, service names and trademarks are the property of their respective owners.

## 16. Contact information

For more information, please visit: <http://www.nexperia.com>

For sales office addresses, please send an email to: [salesaddresses@nexperia.com](mailto:salesaddresses@nexperia.com)

## 17. Contents

---

<b>1</b>	<b>General description</b> .....	<b>1</b>
<b>2</b>	<b>Features</b> .....	<b>1</b>
<b>3</b>	<b>Ordering information</b> .....	<b>1</b>
<b>4</b>	<b>Functional diagram</b> .....	<b>2</b>
<b>5</b>	<b>Pinning information</b> .....	<b>2</b>
5.1	Pinning .....	2
5.2	Pin description .....	3
<b>6</b>	<b>Functional description</b> .....	<b>3</b>
<b>7</b>	<b>Limiting values</b> .....	<b>3</b>
<b>8</b>	<b>Recommended operating conditions</b> .....	<b>4</b>
<b>9</b>	<b>Static characteristics</b> .....	<b>4</b>
<b>10</b>	<b>Dynamic characteristics</b> .....	<b>6</b>
<b>11</b>	<b>Waveforms</b> .....	<b>7</b>
<b>12</b>	<b>Package outline</b> .....	<b>10</b>
<b>13</b>	<b>Abbreviations</b> .....	<b>13</b>
<b>14</b>	<b>Revision history</b> .....	<b>13</b>
<b>15</b>	<b>Legal information</b> .....	<b>14</b>
15.1	Data sheet status .....	14
15.2	Definitions .....	14
15.3	Disclaimers .....	14
15.4	Trademarks .....	14
<b>16</b>	<b>Contact information</b> .....	<b>14</b>
<b>17</b>	<b>Contents</b> .....	<b>15</b>

# Mouser Electronics

Authorized Distributor

Click to View Pricing, Inventory, Delivery & Lifecycle Information:

[Nexperia:](#)

[74VHC125BQ,115](#) [74VHC125D,118](#) [74VHC125PW,118](#) [74VHCT125BQ,115](#) [74VHCT125D,118](#)  
[74VHCT125PW,118](#)