

REV.	ECN NO.	DESCRIPTION	DRWN	CHK	APPD.	DATE
A0	ECN1008280111	NEW	Andy.Pi	✓	✓	2010-08-27

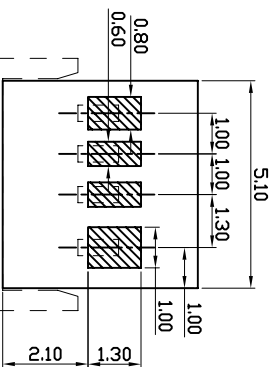
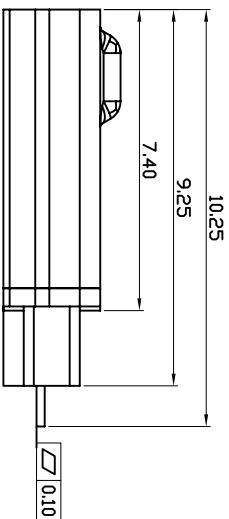
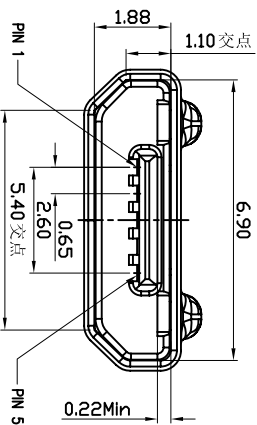
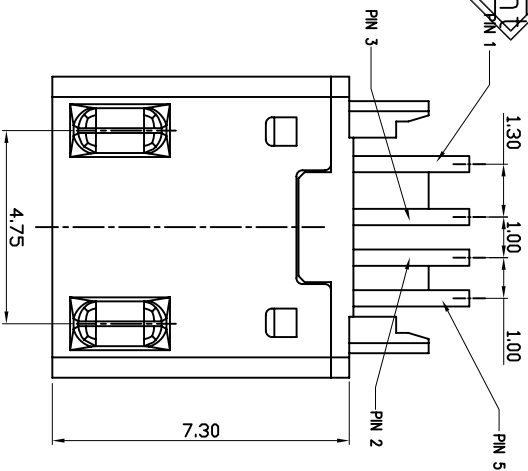
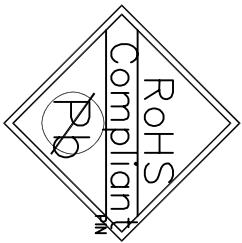

NOTES:
 SPECIFICATION:
 1.1 CURRENT RATING: 1.0A MAX
 1.2 VOLTAGE: 100 VAC
 1.3 TEMPERATURE RANGE: -30 °C ~ 85 °C
 1.4 CONTACT RESISTANCE: 30 MILLIONHM MAX
 1.5 DIELECTRIC WITHSTANDING VOLTAGE: 200 VAC r.m.s
 1.6 INSULATION RESISTANCE: 100 MEGOHMS MIN.

RECOMMEND PCB LAYOUT
 GENERAL TOLERANCE 0.35±0.05

NO.	DESCRIPTION	MATERIAL	REMARKS	QTY
3	SHELL	STAINLESS STEEL WHITE T=0.25mm	TiN/NI Plated	1PCS
2	CONTACT	COPPER ALLOY T=0.20mm	Au/NI Plated	1SET
1	HOUSING	High temperature plastic	BLACK	1PCS

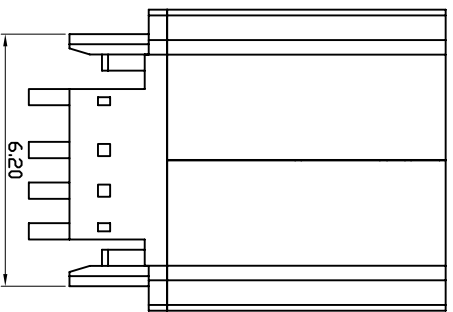
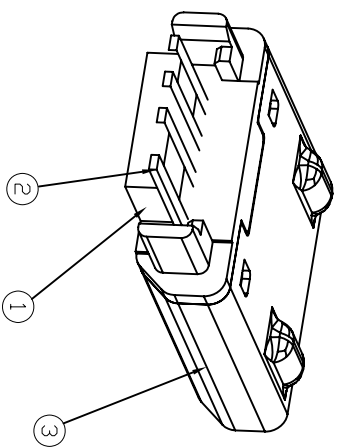

UNITS	SCALE	REV.	SHEET
mm	1:1	A0	1 OF 1
GENERAL TOLERANCE		DATE	2010-08-27
DR.		DR.	Andy.Pi
CHK.		CHK.	
APPD.		APPD.	

TITLE: Micro USB B Type Female

深圳市精拓金电子有限公司

GENERAL TOLERANCE	0. ±0.35	MATL	SEE TABLE	FINISH	SEE TABLE
	0.0 ±0.25	DWG.NO.	DWG-MUB 5F-088	PART NO.	MRF05428201005U
	0.00 ±0.15	APPD.	A	SIZE	A4
	0.° ±3°				
	0.0° ±2°				