

MAPX	MODIFICATION	DATE
------	--------------	------

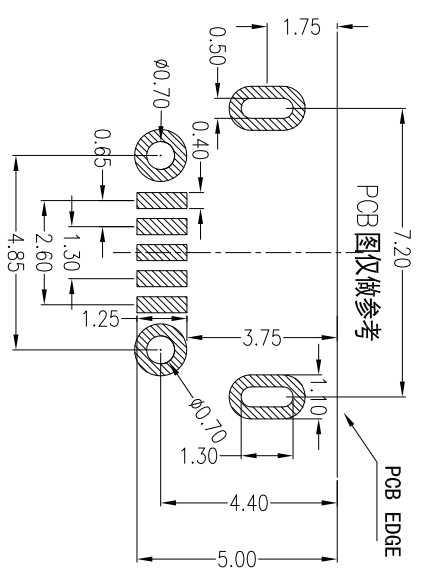
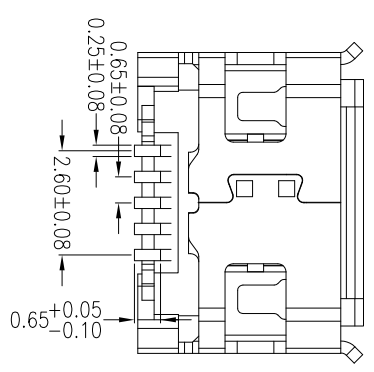
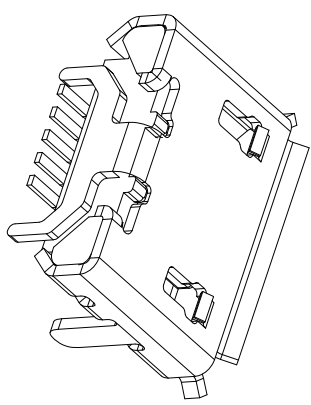
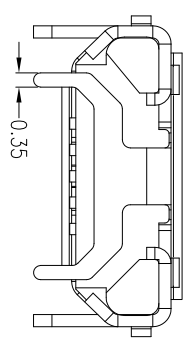
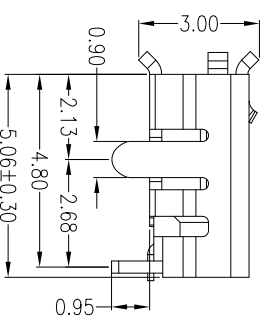
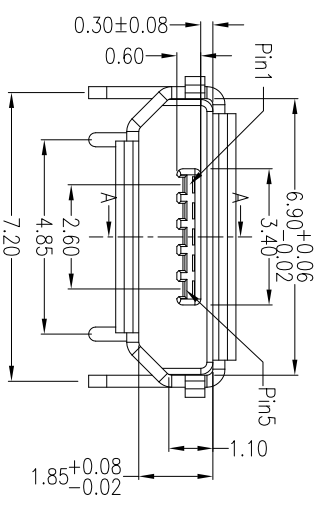
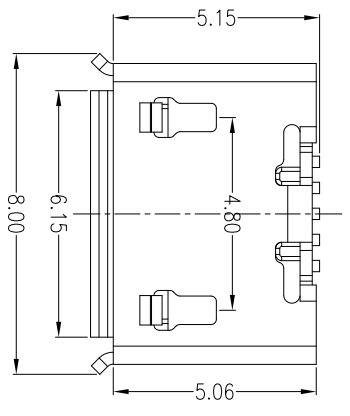

- Note:
- Material:
    - Housing: High temperature thermoplastic with g.f,UL94v-0
    - Contact: copper alloy,t=0.15mm
    - Shell: copper alloy or sus,t=0.30mm
  - Specification:
    - Current rating:1.5PIN 1.8A Max/2,3,4PIN 1A Max.
    - Dielectric withstanding voltage: 100 V(ac) for 1 min.
    - Contact resistance: 30 mΩ Max.
    - Insulation resistance: 100 MΩ Min.
    - Total mating force: 3.57 Kgf Max.
    - Total unmating force: 1.0 Kgf Min.
    - Temperature range: -30°C~80°C

产品图  
PRODUCT CHART DWG

深圳市精拓金电子有限公司

公差一览表 TOLERANCE UNLESS OTHERWISE		单位 UNITS	MM	制图 DRAWING	Gavin	制料号 PRODUCT PART NO.	MIRCO USB 5S B TYPE
X	±0.35	X	±5°	审核 CHKD	郭治富	产品名称 PRODUCT NO.	四脚全填充(插型)短针
X	±0.30	X	±2°	核准 APPD	黄国荣	角法 VIEW	版本 VER
XX	±0.20	XX	±1°	日期 DATE	2016-09-09	角法 VIEW	版本 VER
XXX	±0.10	.XXX	±0.5°	日期 DATE		角法 VIEW	版本 VER

G 1 2 3 4 5 6 7 8 9 10 G  
F E D C B A