

NOTES:

SPECIFICATION:

1. CURRENT RATING: 5.0A MAX
2. VOLTAGE: 100 VAC
3. TEMPERATURE RANGE: -30 °C ~ 85 °C
4. CONTACT RESISTANCE: 40 MILLIONHM MAX
5. INSULATION RESISTANCE: 100 MEGOHMS MIN.
6. INSERTION FORCE : 5N~20N
7. UNMATING FORCE: 8N~20N
8. DURABILITY: 10,000 CYCLES
9. WATER PROOFNESS: THIS PRODUCT IS BASED ON IPX6.

RECOMMENDED P.C.B. LAYOUT  
TOLERANCE UNSPECIFIED ±0.05mm

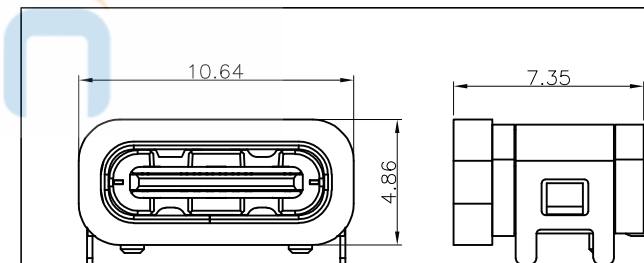
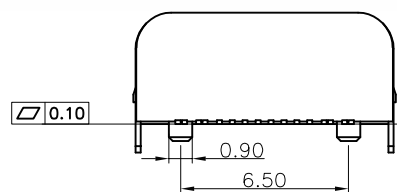
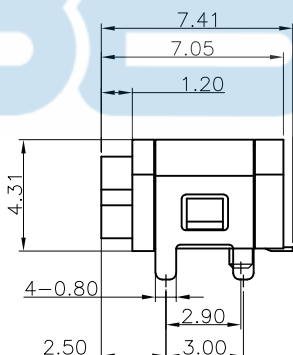
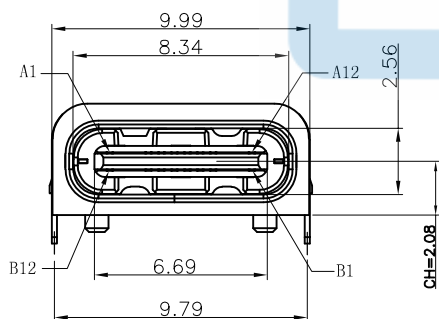

带防水圈示意图

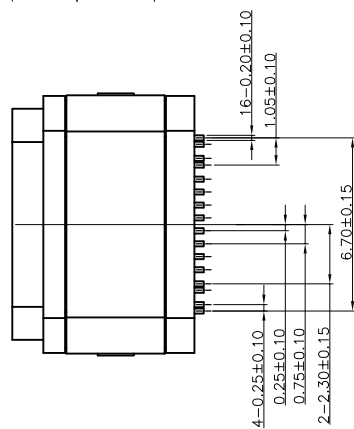

A1	GND	B12	GND
A4	VBUS	B9	VBUS
A5	CC1	B8	SBU2
A6	DP1	B7	DN2
A7	DN1	B6	DP2
A8	SBU1	B5	CC2
A9	VBUS	B4	VBUS
A12	GND	B1	GND
PIN	SIGNAL NAME	PIN	SIGNAL NAME

6	防水圈	硅胶	BLACK	1PCS
5	SHELL	STAINLESS STEEL	NI Plated	1PCS
4	SHIELDING PLATE	STAINLESS STEEL	NI Plated	1PCS
3	CONTACT	COPPER ALLOY	TIN/Au/NI Plated	1SET
2	SHELL HOUSING	HIGH TEMPERATURE PLASTIC	BLACK	1PCS
1	HOUSING	HIGH TEMPERATURE PLASTIC	BLACK	1PCS
NO.	DESCRIPTION	MATERIAL	REMARKS	QTY

TOLERANCE		NAME(INTENDED USE) CUSTOMER DRAWING		深圳市步步精科技有限公司	
X.X ±0.30	X.* ± 2*	0395-1		TITLE: TYPE-C 16P 防水母座板上四脚插L=7.05带柱IPX6 CH=2.08	
.XX ±0.20	.X* ± 1*			APPD: LJP	
.XXX ±0.10	.XX* ±0.5*			PART NO. UC.01.51-1J-0001	
UNITS	mm	MATERILA	CHED: LYX	SCALE	SHEET
FINISH		FINISH	DRAW: HMY	1:1	1/1
				REV.	A



REV.	ECN NO.	DESCRIPTION	DRAW	APPD.	DATE
A	---	新版本发行 (INITIAL EDITION)			



C F单排16P板上型成品

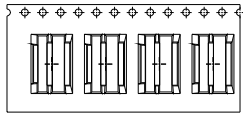

① 产品入载带示意图

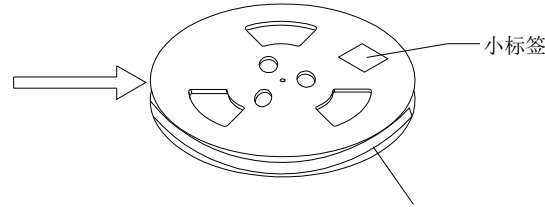

② 卷盘贴标签示意图

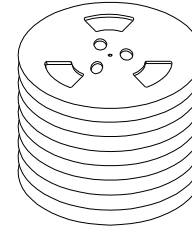

③ 10盘产品叠层示意图

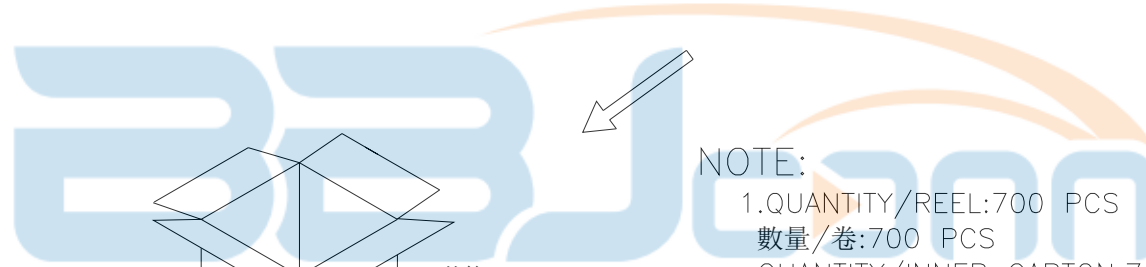

NOTE:

- 1. QUANTITY/REEL: 700 PCS  
數量/卷: 700 PCS  
QUANTITY/INNER CARTON: 700 X 10 = 7000 PCS  
數量/箱: 700 X 10 = 7000 PCS
- 2. FREE 20 CAVE IN THE FRONT CARRIER AND FREE 20 CAVE IN THE END CARRIER.  
包裝帶內圈空20格,外圈空20格。

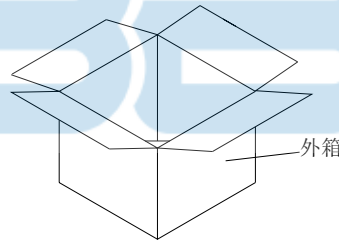

④ 产品入外箱示意图

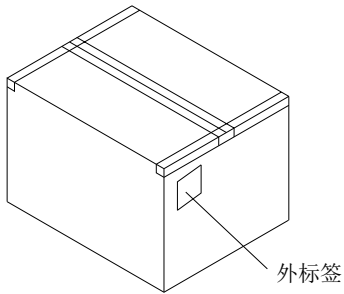

⑤ 外箱封箱示意图



1	成品		C F6P防水型沉板母座成品	8000
2	CARRIER TAPE	PET	W=24mm T=0.35mm	---
3	COVER TAPE	PET	W=13.3mm T=0.05mm	---
4	小标签		L102mm*W59mm	10
5	卷盘	PS	ø330MM*W28.5MM	10
6	外标签		L102mm*W102mm	1
7	外箱	A=A	L330mm*W330mm*320mm	1
ITEM	DESC.	MATERIAL	REMARKS	QTY
TOLERANCE		NAME(INTENDED USE) 包装规范		深圳市步步精科技有限公司
X. ±0.20	X.* ± 2°	0395-1		TITLE: TYPE-C 16P 防水母座板上四脚插=7.05带柱1PX6 CH=2.08
.X ±0.15	.X* ± 1°	APPD:	LJP	PART NO. UC.01.51-1J-0001
.XX ±0.10	.XX* ±0.5°	MATERILA	CHED: LYX	SCALE SHEET REV. NONE 1/1 A
FINISH		DRAW:	HMY	