

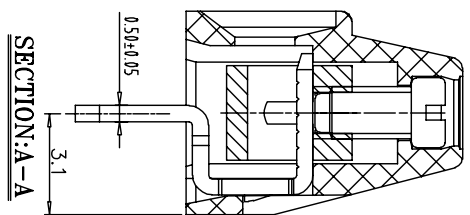

ZONE	REV	DESCRIPTION	DATE	APPROVED

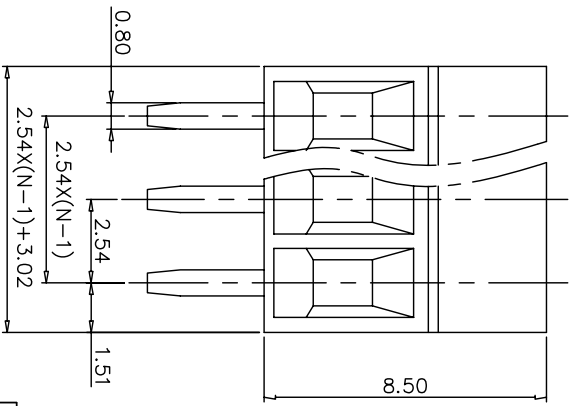
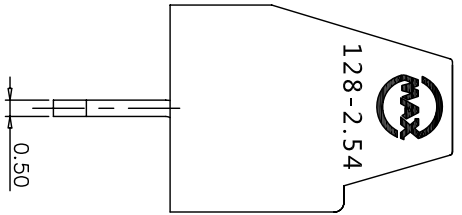
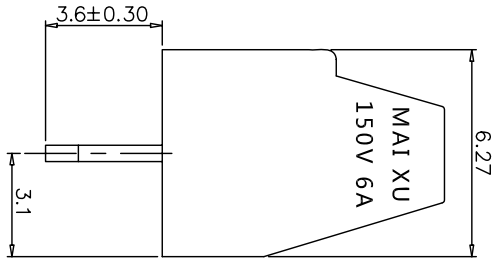
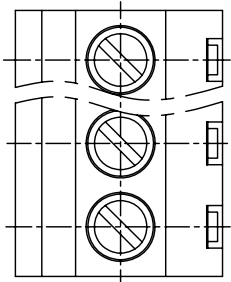
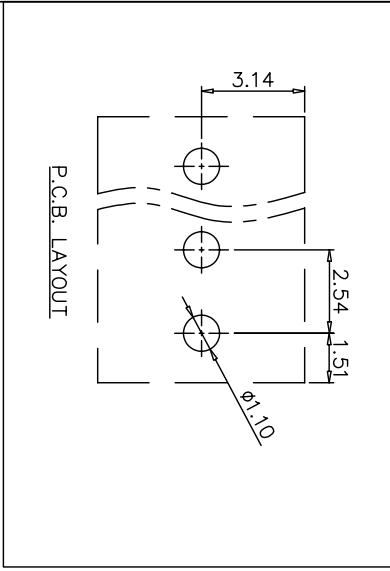

- NOTES1:
- 1. UL Standard
  - 1. Rated voltage/current : 150V / 6A
  - 2. Torque value : M1.6 , 1.29Lb.in
  - 3. Wire range : 26~18AWG
- IEC Standard
- 1. Rated voltage/current : 130V / 8A
  - 2. Torque value : M1.6 , 0.15N.m
  - 3. Wire range : 0.5~1.0mm<sup>2</sup>
- NOTES2:
- 1. Dimension shall be interpreted per ASME Y14.5-2009
  - 2. Pitch : 2.54mm, Poles : N=02-12P
  - 3. Stripping length : 4~5mm
  - 4. Withstanding voltage : AC1250V/1min
  - 5. Operating temperature : -40°C~+105°C
  - 6. RoHS Compliance

Total Pitch Tolerances												Nominal dimension range											
over	0	30	53	70	90	115	150	250	350	500		over	0	30	53	70	90	115	150	200	250	320	
±0.18	±0.20	±0.25	±0.3	±0.35	±0.44	±0.60	±0.70	±0.85	±0.20	±0.25	±0.30	±0.35	±0.44	±0.55	±0.70	±0.80	±0.90	0.2	0.3	0.3	0.2	0.3	0.5



**慈溪市迈旭电子有限公司**  
 Cixi Maixu Electronics Co., Ltd.

MX128-2.54-XXP-XC

CHKD:	/	SIZE	FSQM NO.	DWG NO.	REV
DRFT:	/	MM (INCH)	DO NOT SCALE DRAWING	SHEET	