

SPECIFICATIONS

产品规格书

客户名称 Customer		产品名称 Product	TX1818B
客户代码 Customer NO.		产品型号 Type	TC5050RGB-3CJH- TX1818B

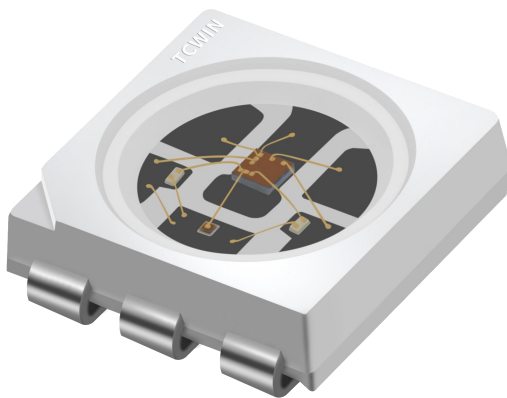

5050 内置 IC 幻彩

断点续传 LED 光源

5.0 x 5.4 x 1.6 mm

0.2W SMD LED 器件



地址：深圳市宝安区松岗街道东方大道 33 号

电话：0755-29573599 29573979 传真：0755-29573533

网址：<http://www.tczmlcd.com> 邮编：518106



目 录

1、产品概述.....	3
2、主要应用.....	3
3、特征说明.....	3
4、产品尺寸.....	4
5、产品命名规则.....	4
6、引脚功能.....	5
7、RGB 光电特性.....	5
8、绝对最大值.....	6
9、IC 电气参数.....	6
10、开关特性.....	6
11、数据传输时间.....	7
12、时序波形图.....	7
13、数据传输方式.....	8
14、24bit 数据结构.....	8
15、典型应用电路.....	8
16、光电特性曲线.....	9
17、包装.....	10
18、可靠性测试.....	11
19、焊接说明.....	112
20、注意事项.....	113

1. Description(产品描述)

TX1818B 是一个集控制电路与发光电路于一体的智能外控 LED 光源。其外型与一个 5050LED 灯珠相同，每个元件即为一个像素点。像素点内部包含了智能数字接口数据锁存信号整形放大驱动电路，电源稳压电路，内置恒流电路，高精度 RC 振荡器，输出驱动采用专利 PWM 技术，有效保证了像素点内光的颜色高一致性。

数据协议采用单极性归零码的通讯方式，像素点在上电复位以后，DIN 端接受从控制器传输过来的数据，首先送过来的 24bit 数据被第一个像素点提取后，送到像素点内部的数据锁存器，剩余的数据经过内部整形处理电路整形放大后通过 DO 端口开始转发输出给下一个级联的像素点，每经过一个像素点的传输，信号减少 24bit。

LED 具有低电压驱动，环保节能，亮度高，散射角度大，一致性好，超低功率，超长寿命等优点。将控制电路集成于 LED 上面，电路变得更加简单，体积小，安装更加简便。

2. Applications (主要应用)

- LED 全彩发光字灯串, LED 全彩模组, LED 幻彩软硬灯条, LED 护栏管, LED 外观/情景照明。
- LED 点光源, LED 像素屏, LED 异形屏, 各种电子产品, 电器设备跑马灯。

3. Features (特征说明)

- 单颗 IC 或灯珠损坏不影响后续数据;
- 默认输出恒流值 9mA, 便于降低内置灯珠功耗;
- 灰度调节电路 (256 级灰度可调);
- 双输入串行级联接口 (DIN, FDIN);
- 内置高精度和高稳定性振荡器;
- 数据整形: 接受完本单元数据自动将后续数据整形输出;
- 数据传输频率可达 800Kbps。

4. Package Dimensions (产品尺寸)

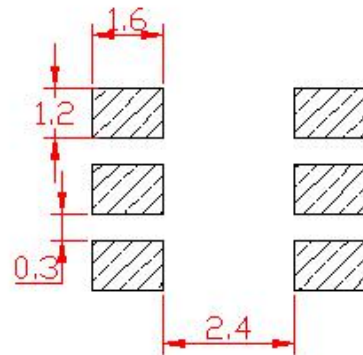
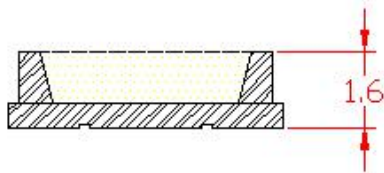
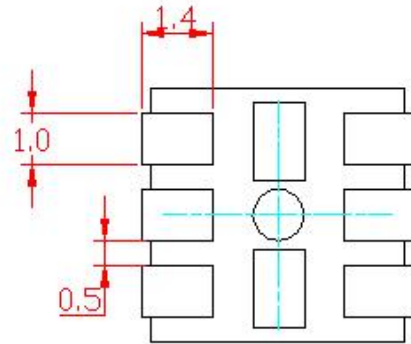
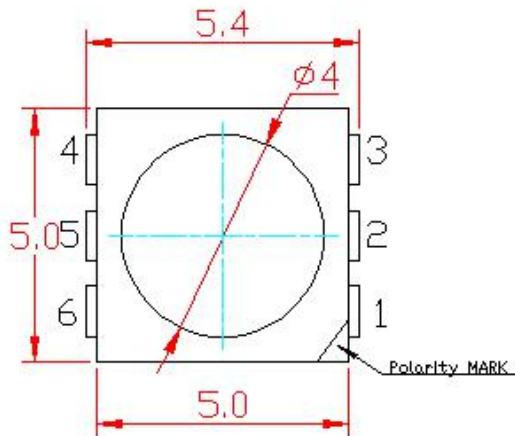

Recommended size of solder pad

建议焊盘尺寸

注:

- 所有标注尺寸的单位均为 mm;
- 除了特别注明, 所有标注尺寸的公差均为 $\pm 0.2\text{mm}$;
- 封装尺寸: $5.0 \times 5.4 \times 1.6\text{mm}$;

5. Product naming principle (产品命名规则)

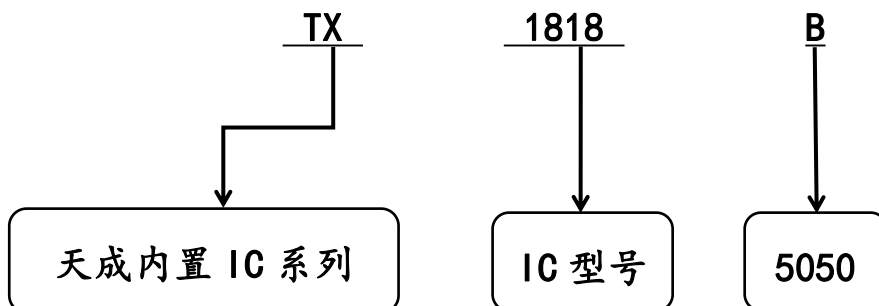

6. Pin function (引脚功能)

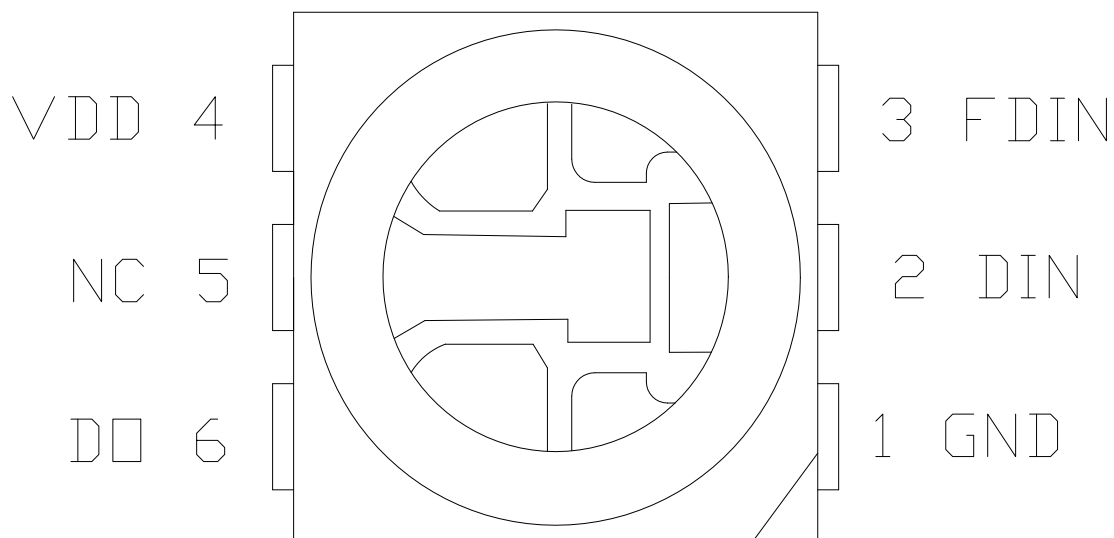

序号	符号	管脚名	功能描述
1	GND	地	信号接地和电源接地
2	DIN	数据输入	显示信号输入
3	FDIN	备用数据输入	备用显示信号输入
4	VDD	电源	供电管脚
5	NC	空脚	悬空处理
6	DO	数据输出	控制数据信号输出

7. Electro-optical characteristics at Ta=25°C (RGB 光电特性)

Item 项目	Symbol (符号)	Mix (最小)	Typ (平均)	Max (最大)	Unit (单位)	Conditions (测试条件)	
Dominant wavelength (主波长)	λ d	G	520		525	nm	IF=9mA
		R	620		625		
		B	465		470		
Luminous intensity (发光强度)	IV	G	600		1000	mcd	IF=9mA
		R	150		350		
		B	100		200		

8. Absolute maximum ratings at Ta=25°C (绝对最大额定值)

参数	符号	范围	单位
电源电压	VDD	-0.4 ~ 14	V
逻辑输入电压	V1	-0.5~VDD+0.5	V
工作温度	Topt	-40 ~ 85	°C
储存温度	Tstg	-40 ~ 120	°C
ESD耐压	VESD	2K	V

9. IC Electric Spec (IC 电气参数)

参数	符号	最小	典型	最大	单位	测试条件
芯片电源电压	Vin	10.8	12	13.2	V	--
R/G/B输出驱动电流	Lout	8.82	9	9.18	mA	--
信号输入翻转阈值	VIH	4	--	--	V	VDD=12V
	VIL	--	--	1	V	
PWM频率	FPWM	--	8	--	KHZ	--
静态功耗	IDD	--	2	--	mA	--

10. Dynamic parameter (开关特性)

参数	符号	最小	典型	最大	单位	测试条件
数据传输速度	FDIN	--	800	--	KHZ	
传输延迟时间	TPLZ	--	--	200	ns	DIN→DO
输出电流转换时间	Tr	--	--	200	ns	Vds=1.5V I0=9mA
	Tf	--	--	200	ns	

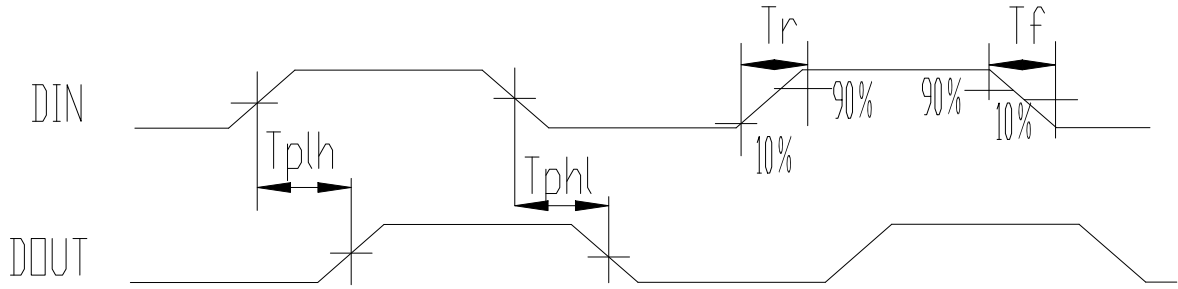

11. The data transmission time (数据传输时间)

名称	描述	典型值	容许误差
T0H	0码, 高电平时间	0.3 μ s	$\pm 0.05\mu$ s
T1H	1码, 高电平时间	0.9 μ s	$\pm 0.05\mu$ s
T0L	0码, 低电平时间	0.9 μ s	$\pm 0.05\mu$ s
T1L	1码, 低电平时间	0.3 μ s	$\pm 0.05\mu$ s
Trst	Reset码, 低电平时间	$\geq 80\mu$ s	--

12. Temporal waveform figure (时序波形图)

输入码型:

连接方式:

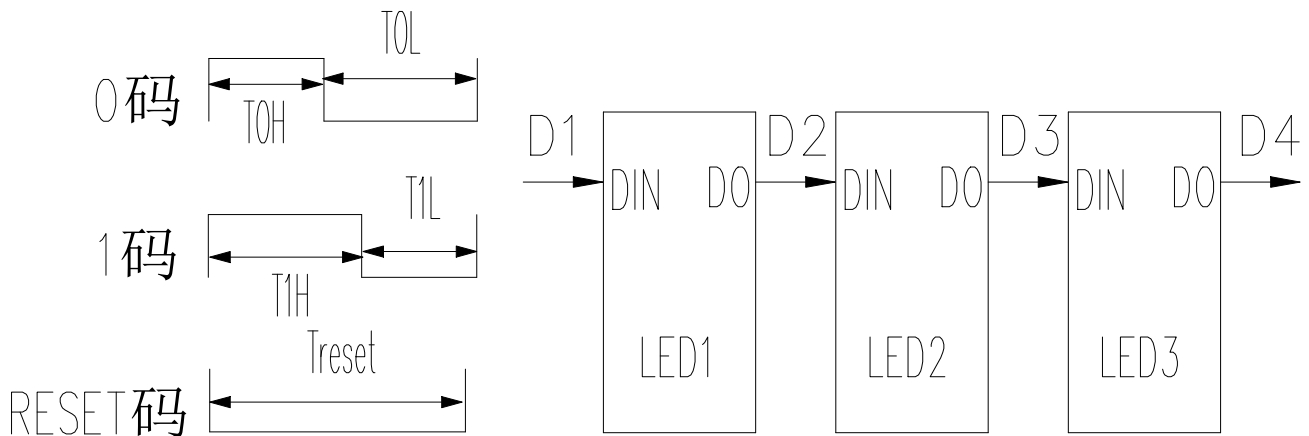

13. Mode of data transmission (数据传输方式)

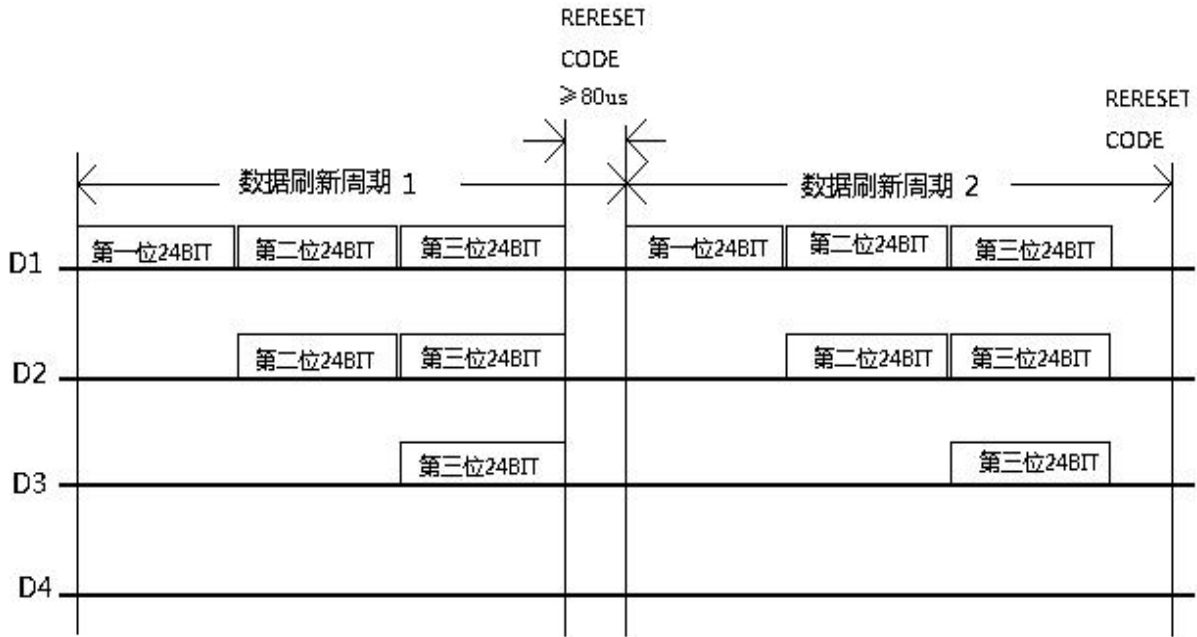

注: 其中 D1 为 MCU 端发送的数据, D2、D3、D4 为级联电路自动整形转发的数据

14. Mode of data transmission (24bit 数据结构)

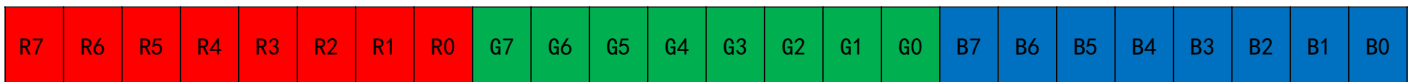

注: 高位先发, 按照 RGB 的顺序发送数据

15. Typical application circuit (典型应用电路)

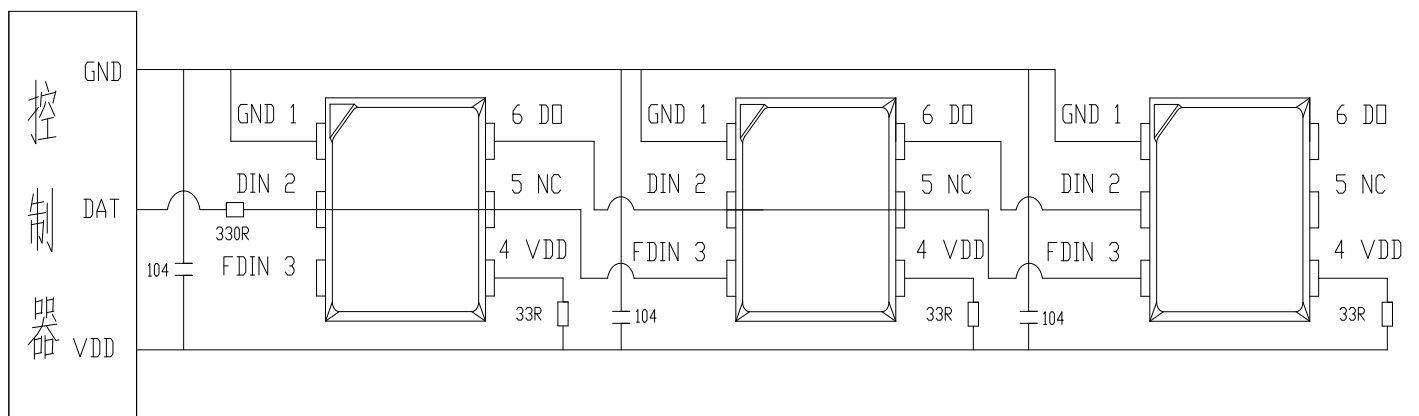

注: 为防止产品在测试时带电插拔产生的瞬间高压导致芯片信号输入输出引脚损坏, 应该在电源引脚串接 33Ω 保护电阻。此外, 图中各芯片的退耦电容 (0.1μF) 不可缺少, 且走线到芯片的 VDD 和 GND 脚应尽量短, 以达到最佳的退耦效果, 稳定芯片工作, 同时需在信号输入端串接一个 330 欧的保护电阻。

16. Typical optical characteristics curves (光电特性曲线)

Spectral Distribution

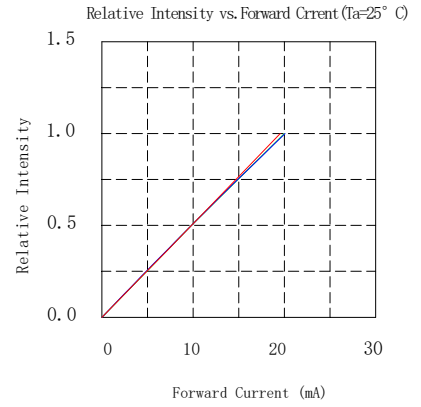
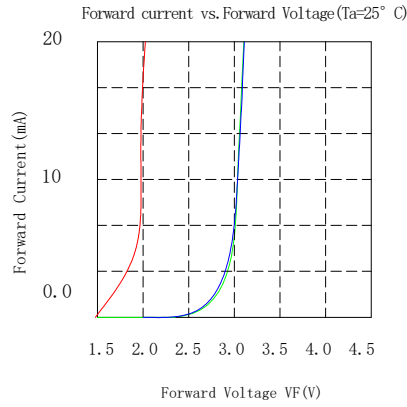
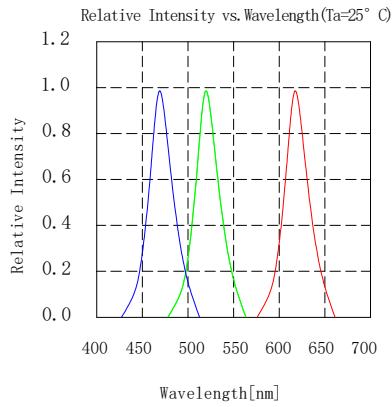

Detrating

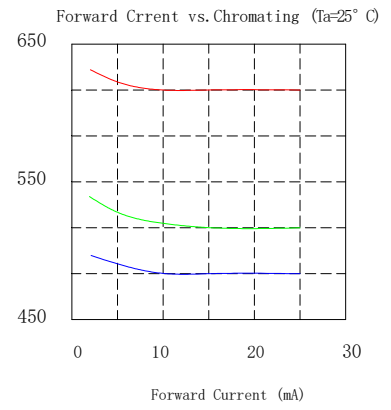
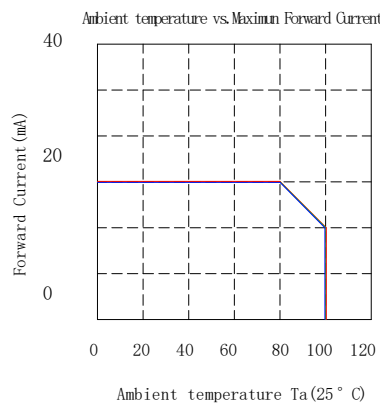
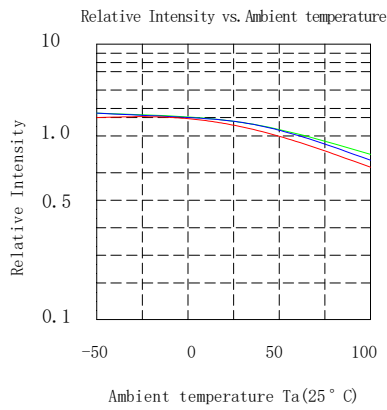
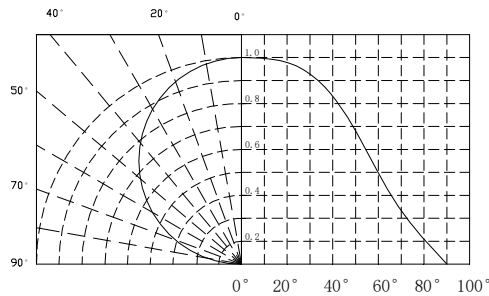
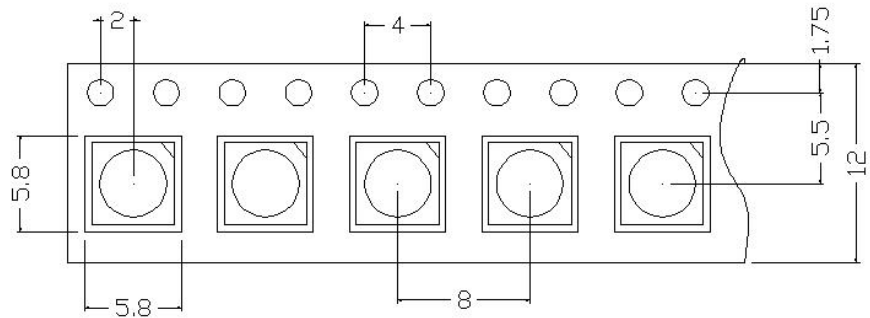

Diagram characteristics of radiation



17. Packaging Specifications (包装规格)

● Feeding Direction (进料方向)



卷盘尺寸: 178x12mm

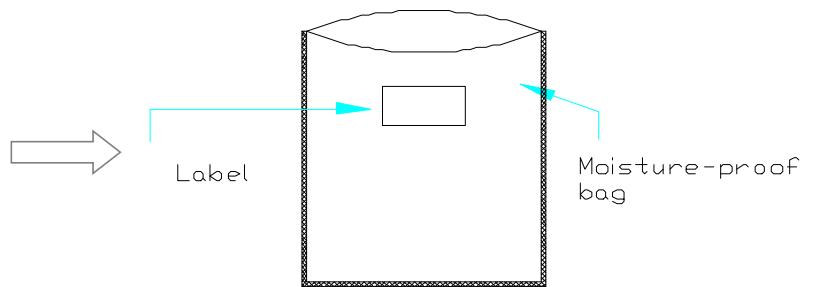
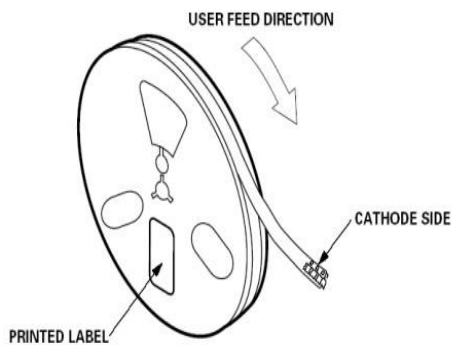

Vacuum

深圳市天成照明有限公司
 PN:TC3838RGB-3CJH
 SN:TX1812EB-12345678
 CIEXY:I C
 QTY:1003pcs
 3838四脚
 幻影灯珠
 2020.12.11

IF12mA	R	G	B
VF(v)	2.0-2.2	3.0-3.2	3.0-3.2
IV(mcd)	500-700	1300-1800	300-500
λd(nm)	620-625	525-530	465-470

真空包装拆包后必须在8小时内使用完成

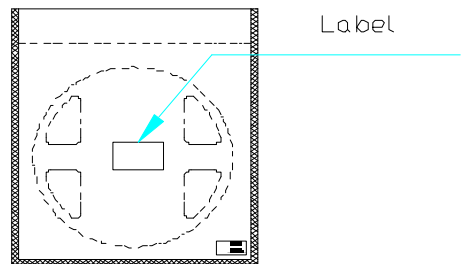
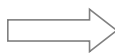

标签图示

Note: volume is 1000pcs; 每卷数量 1000pcs;

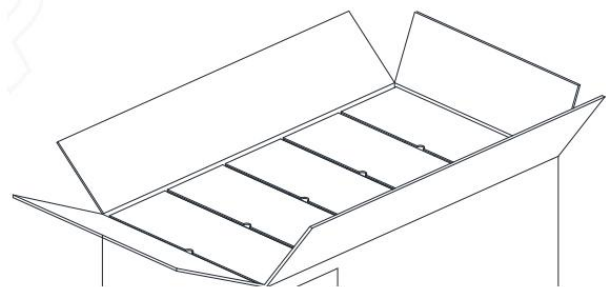

18. Reliability (可靠性)

TEST ITEMS AND RESULTS (测试项目和结果)

序号	Test Item (测试项目)	Ref. Standard (参考标准)	Test Conditions (测试条件)	Note (备注)	Conclusion (结论)
1	Reflow Soldering (回流焊)	JESD22-B106	T _{sld} =240°C, 10sec	3 times	0/22
2	Temperature Cycle (温度循环)	JESD22-A104	-20°C 30min ↑ ↓ 15min 120°C 30min	200 cycle	0/22
3	Thermal Shock (冷热冲击)	JESD22-A106	-40°C 15min ↑ ↓ 15sec 125°C 15min	200 cycle	0/22
4	High Temperature Storage (高温存储)	JESD22-A103	T _a =100°C	1000 hrs	0/22
5	Low Temperature Storage (低温存储)	JESD22-A119	T _a =-40°C	1000 hrs	0/22
6	Power temperature Cycling (点亮高低温循环)	JESD22-A105	On 5min -40°C > 15min ↑ ↓ ↑ ↓ < 15min Off 5min 100°C > 15min	200 cycle	0/22
7	Life Test (老化测试)	JESD22-A108	T _a =25°C I _F =9mA	1000 hrs	0/22
8	High Humidity Heat Life Test (高温高湿)	JESD22-A101	60°C RH=90% I _F =9mA	1000 hrs	0/22

19. Reflow profile (焊接说明)

■ SMD Reflow Soldering Instructions (回流焊简介)

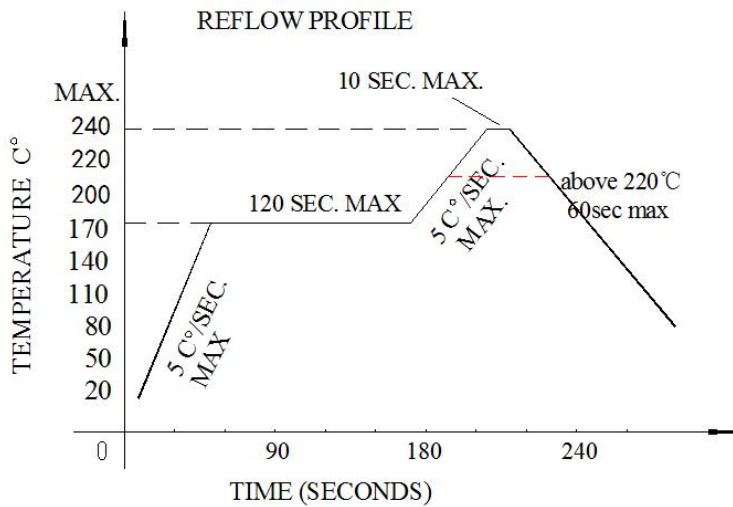

- a. Reflow soldering should not be done more than two times

回流焊次数不应超过 2 次

- b. When soldering ,do not put stress on the LEDs during heating

焊接时, 在加热过程中不能有应力作用于 LED 灯珠

■ Soldering iron (烙铁)

- a. When hand soldering, keep the temperature of the iron under 300°C, and at that temperature keep the time under 3 sec.

手工焊接时, 烙铁温度控制在 300°C 以下, 且时间不可超过 3 秒

- b. The hand soldering should be done only a time 手工焊接只可焊接一次;

■ Rework (返工)

- a. Customer must finish rework within 5 sec under 240°C

温度保持在 240°C 以下, 5 秒内完成返工作业

- b. The head of iron can not touch the LEDs

烙铁不能碰触到 LED 灯珠

- c. Twin-head type is preferred. 双头形烙铁为最佳

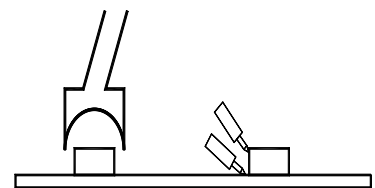

20. CAUTIONS (注意事项)

➤ Note for use 使用注意事项

In order to ensure that IC lamp beads are used in SMT patch reflow welding and in the use of the process yield and stability of the product, the following procedures are specified after many tests:

为确保内置 IC 灯珠产品在 SMT 贴片回流焊和使用过程良率及产品稳定性，经过多次试验验证特制订以下各工序相关注意事项如下：

a、 Sample evaluation: Because this product is a built-in IC product, the overall process is different from conventional RGB products, so the customer side needs to carry out all-round verification during the sample evaluation to ensure the matching performance of the product;

样品评估：因本产品为内置 IC 产品，整体工艺差别于常规 RGB 产品，所以客户端在样品评估时需进行全方位验证，确保产品的匹配性能；

b、 Incoming material inspection: ensure the vacuum packing is intact and there is no vacuum leakage. If there is vacuum leakage, please confirm whether the reflow welding is abnormal. If it is abnormal, please return to the factory for high-temperature dehumidification.

来料检验：确保真空包装完好，无漏真空现象，如有漏真空请确认回流焊是否异常，如异常需返厂重新高温除湿；

c、 Use: Please confirm the first piece before the formal SMT. According to the principle of one pack and one package, the lamp bead should not be exposed to air for more than 4 hours. The lamp bead should be reflow welded within 2 hours after the SMT is finished.

使用：正式贴片前请先做好首件确认，使用时按拆一包用一包的原则，灯珠裸露在空气中不得超过 4 小时，贴片完成灯珠需在 2 小时以内过完回流焊，使用锡膏为中低温锡膏，回流焊最高温度不得超过 240 度；

d、 Maintenance: material should be completed within 4 hours and domestic demand after reflow soldering test and repair the lamp bead, such as more than 4 hours need to repair the lamp plate temperature above 65 °C dehumidification 12 hours to repair work, and repair the lamp bead also must carry on the low temperature above 65 °C dehumidification 12 hours, use prohibited in the process of maintenance with temperature over 240 °C heating machine repair, prohibit the whole plate placed in the heating stage repair, follow the principle of bad which return which measuring.

维修：材料在回流焊后 4 小时内需完成测试和维修灯珠，如超过 4 小时需将要维修灯板低温 65°C 除湿 12 小时以上才可进行维修作业，且维修所需的灯珠也要进行低温 65°C 除湿 12 小时以上才可使用，维修过程中禁止用温度超过 240°C 加热台进行返修，禁止整板放置于加热台上返修，遵循坏哪颗返哪颗的原则。

e、 Warm prompt: the whole process special considerations for light bead before use vacuum packing, dehumidification, SMT placement time and workshop of temperature and humidity control, product maintenance lamp plate if bare at room temperature environment for a long time need to dehumidification, light board and light bead light beads as LED electronic products, need to pay attention to moisture in spring and summer, autumn and winter anti-static, product quality is enterprise's life, to the quality strives for the survival, to the quality strives for the development is our consistent aim. Also in order to ensure the quality of the client, please strictly refer to the above recommendations

温馨提示：整个工序特别注意事项为灯珠使用前真空包装、除湿后贴片放置时间和车间的温湿度管控，产品维修时灯板如裸露在室温环境时间过长灯板和灯珠需进行除湿，灯珠为 LED 电子元器件产品，需注意春夏季防潮，秋冬季防静电，产品品质就是一家企业的生命，以质量求生存，以质量求发展是我司的一贯宗旨。也为保证客户端品质，请严格参照以上建议操作。

防潮等级定义

防潮等级验证						
防潮等级	材料拆包后使用寿命		验证条件			
	时间	条件	标准条件		加速条件	
			时间	条件	时间	条件
LEVEL1	无限制	$\leq 30^{\circ}\text{C}/85\%RH$	168+5/-0H	$85^{\circ}\text{C}/85\%RH$	/	/
LEVEL2	1 年	$\leq 30^{\circ}\text{C}/60\%RH$	168+5/-0H	$85^{\circ}\text{C}/60\%RH$	/	/
LEVEL2a	4 周	$\leq 30^{\circ}\text{C}/60\%RH$	696+5/-0H	$30^{\circ}\text{C}/60\%RH$	120+5/-0H	$60^{\circ}\text{C}/60\%RH$
LEVEL3	168 小时	$\leq 30^{\circ}\text{C}/60\%RH$	192+5/-0H	$30^{\circ}\text{C}/60\%RH$	40+5/-0H	$60^{\circ}\text{C}/60\%RH$
LEVEL4	72 小时	$\leq 30^{\circ}\text{C}/60\%RH$	96+5/-0H	$30^{\circ}\text{C}/60\%RH$	20+5/-0H	$60^{\circ}\text{C}/60\%RH$
LEVEL5	48 小时	$\leq 30^{\circ}\text{C}/60\%RH$	72+5/-0H	$30^{\circ}\text{C}/60\%RH$	15+5/-0H	$60^{\circ}\text{C}/60\%RH$
LEVEL5a	24 小时	$\leq 30^{\circ}\text{C}/60\%RH$	48+5/-0H	$30^{\circ}\text{C}/60\%RH$	10+5/-0H	$60^{\circ}\text{C}/60\%RH$
LEVEL6	取出即用	$\leq 30^{\circ}\text{C}/60\%RH$	取出即用	$30^{\circ}\text{C}/60\%RH$	/	/

➤ The encapsulated material of the LEDs is silicone. Therefore the LEDs have a soft surface on the top of package. The pressure to the top surface will be influence to the reliability of the LEDs. Precautions should be taken to avoid the strong pressure on the encapsulated part. So when using the picking up nozzle, the pressure on the silicone resin should be proper.

封装的 LED 为硅材料。该 LED 具有软表面的封装顶部。顶部表面的压力会影响 LED 的可靠性。应采取预防措施，以避免有过大的压力作用于在封装件上。因此，在选用吸嘴时，应适用于有机硅树脂的压力。

