

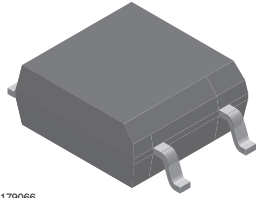

## Optocoupler Phototransistor Output, SOP-4, Mini-Flat Package, 110 °C Rated

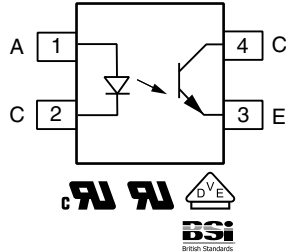

1179066



### FEATURES

- Operating temperature from - 55 °C to + 110 °C
- SOP (small outline package)
- Isolation test voltage, 3750 V<sub>RMS</sub> (1 s)
- Low saturation voltage
- Fast switching times
- Low coupling capacitance
- End-stackable, 0.100" (2.54 mm) spacing
- Material categorization: for definitions of compliance please see [www.vishay.com/doc?99912](http://www.vishay.com/doc?99912)



### DESCRIPTION

The 110 °C rated SFH1690AT, SFH1690BT, SFH1690CT, and SFH1690ABT family has a GaAs infrared emitting diode emitter, which is optically coupled to a silicon planar phototransistor detector, and is incorporated in a 4 pin 100 mil lead pitch miniflat package. It features a high current transfer ratio, low coupling capacitance, and high isolation voltage.

The coupling devices are designed for signal transmission between two electrically separated circuits. The SFH1690 series is available only on tape and reel. There are 2000 parts per reel.

### APPLICATIONS

- PLCs
- Telecommunication

### AGENCY APPROVALS

- UL1577, file no. E52744 system code U
- cUL - file no. E52744, cUL tested to CSA 22.2 bulletin 5A
- DIN EN 60747-5-2 (VDE 0884)/DIN EN 60747-5-5 (pending) available with option 1
- BSI tested to IEC 60065 and IEC 60950-2001

ORDERING INFORMATION				
<div style="display: flex; justify-content: space-around; align-items: center;"> <div style="border: 1px solid black; padding: 2px;">S</div> <div style="border: 1px solid black; padding: 2px;">F</div> <div style="border: 1px solid black; padding: 2px;">H</div> <div style="border: 1px solid black; padding: 2px;">1</div> <div style="border: 1px solid black; padding: 2px;">6</div> <div style="border: 1px solid black; padding: 2px;">9</div> <div style="border: 1px solid black; padding: 2px;">0</div> <div style="border: 1px solid black; padding: 2px;">#</div> <div style="border: 1px solid black; padding: 2px;">#</div> <div style="border: 1px solid black; padding: 2px;">T</div> <div style="border: 1px solid black; padding: 2px;">-</div> <div style="border: 1px solid black; padding: 2px;">X</div> <div style="border: 1px solid black; padding: 2px;">0</div> <div style="border: 1px solid black; padding: 2px;">0</div> <div style="border: 1px solid black; padding: 2px;">1</div> </div> <div style="display: flex; justify-content: space-around; margin-top: 5px;"> <div style="text-align: center;">PART NUMBER</div> <div style="text-align: center;">TAPE AND REEL</div> <div style="text-align: center;">VDE OPTION</div> </div>				
AGENCY CERTIFIED/PACKAGE	CTR (%)			
UL, cUL, BSI	50 to 300	50 to 150	100 to 300	100 to 200
SOP-4, Mini flat	SFH1690ABT	SFH1690AT	SFH1690BT	SFH1690CT
VDE, UL, cUL, BSI	50 to 300	50 to 150	100 to 300	100 to 200
SOP-4, Mini flat	-	-	SFH1690BT-X001	-

### Note

- For additional information on the available options refer to option information.



<b>ABSOLUTE MAXIMUM RATINGS</b> ( $T_{amb} = 25\text{ }^{\circ}\text{C}$ , unless otherwise specified)				
PARAMETER	TEST CONDITION	SYMBOL	VALUE	UNIT
<b>INPUT</b>				
DC forward current		$I_F$	50	mA
Reverse voltage		$V_R$	6	V
Surge forward current	$t_p \leq 10\text{ }\mu\text{s}$	$I_{FSM}$	2.5	A
Power dissipation		$P_{diss}$	80	mW
Derate linearly from 25 °C			0.7	mW/°C
<b>OUTPUT</b>				
Collector emitter voltage		$V_{CEO}$	70	V
Emitter collector voltage		$V_{ECO}$	7	V
Collector current		$I_C$	50	mA
	$t_p \leq 1\text{ ms}$	$I_C$	100	mW
Power dissipation		$P_{diss}$	150	mW
Derate linearly from 25 °C			1.5	mW/°C
<b>COUPLER</b>				
Isolation test voltage between emitter and detector	$t = 1\text{ s}$	$V_{ISO}$	3750	$V_{RMS}$
Operating temperature range		$T_{amb}$	- 55 to + 110	°C
Storage temperature range		$T_{stg}$	- 55 to + 150	°C
Soldering temperature	max. 10 s dip soldering distance to seating plane $\geq 1.5\text{ mm}$	$T_{sld}$	260	°C

**Note**

- Stresses in excess of the absolute maximum ratings can cause permanent damage to the device. Functional operation of the device is not implied at these or any other conditions in excess of those given in the operational sections of this document. Exposure to absolute maximum ratings for extended periods of the time can adversely affect reliability.

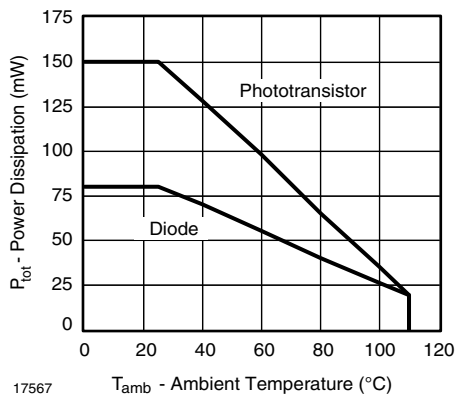

Fig. 1 - Permissible Power Dissipation vs. Temperature

<b>ELECTRICAL CHARACTERISTICS</b> ( $T_{amb} = 25\text{ }^{\circ}\text{C}$ , unless otherwise specified)							
PARAMETER	TEST CONDITION	PART	SYMBOL	MIN.	TYP.	MAX.	UNIT
<b>INPUT</b>							
Forward voltage	$I_F = 5\text{ mA}$		$V_F$		1.15	1.4	V
Reverse current	$V_R = 6\text{ V}$		$I_R$		0.01	10	$\mu\text{A}$
Capacitance	$V_R = 0\text{ V}, f = 1\text{ MHz}$		$C_O$		14		pF
<b>OUTPUT</b>							
Collector emitter leakage current	$V_{CE} = 20\text{ V}$		$I_{CEO}$			100	nA
Collector emitter breakdown voltage	$I_C = 100\text{ }\mu\text{A}$		$BV_{CEO}$	70			V
Emitter collector breakdown voltage	$I_E = -10\text{ }\mu\text{A}$		$BV_{ECO}$	7			V
Collector emitter saturation voltage	$I_F = 10\text{ mA}, I_C = 2.5\text{ mA}$		$V_{CEsat}$		0.25	0.4	V
Collector emitter capacitance	$V_{CE} = 5\text{ V}, f = 1\text{ MHz}$		$C_{CE}$		2.8		pF
<b>COUPLER</b>							
Coupling capacitance	$f = 1\text{ MHz}$		$C_C$		0.3		pF
Capacitance (input to output)			$C_{IO}$		0.5		pF

**Note**

- Minimum and maximum values are testing requirements. Typical values are characteristics of the device and are the result of engineering evaluation. Typical values are for information only and are not part of the testing requirements.

<b>CURRENT TRANSFER RATIO</b> ( $T_{amb} = 25\text{ }^{\circ}\text{C}$ , unless otherwise specified)							
PARAMETER	TEST CONDITION	PART	SYMBOL	MIN.	TYP.	MAX.	UNIT
$I_C/I_F$	$I_F = 5\text{ mA}, V_{CE} = 5\text{ V}$	SFH1690ABT	CTR	50		300	%
		SFH1690AT	CTR	50		150	%
		SFH1690BT	CTR	100		300	%
		SFH1690CT	CTR	100		200	%

**Note**

- Minimum and maximum values are testing requirements. Typical values are characteristics of the device and are the result of engineering evaluation. Typical values are for information only and are not part of the testing requirements.

<b>SWITCHING CHARACTERISTICS</b> ( $T_{amb} = 25\text{ }^{\circ}\text{C}$ , unless otherwise specified)							
PARAMETER	TEST CONDITION	SYMBOL	MIN.	TYP.	MAX.	UNIT	
Rise time	$V_{CC} = 5\text{ V}, I_C = 2\text{ mA}, R_L = 100\text{ }\Omega$	$t_r$		3		$\mu\text{s}$	
Fall time	$V_{CC} = 5\text{ V}, I_C = 2\text{ mA}, R_L = 100\text{ }\Omega$	$t_f$		4		$\mu\text{s}$	
Turn-on time	$V_{CC} = 5\text{ V}, I_C = 2\text{ mA}, R_L = 100\text{ }\Omega$	$t_{on}$		5		$\mu\text{s}$	
Turn-off time	$V_{CC} = 5\text{ V}, I_C = 2\text{ mA}, R_L = 100\text{ }\Omega$	$t_{off}$		3		$\mu\text{s}$	

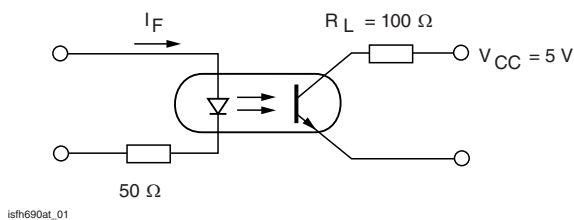

Fig. 2 - Switching Operation (without Saturation)



SAFETY AND INSULATION RATINGS						
PARAMETER	TEST CONDITION	SYMBOL	MIN.	TYP.	MAX.	UNIT
Climatic classification (according to IEC 68 part 1)				55/110/21		
Pollution degree (DIN VDE 0109)				2		mm
Comparative tracking index per DIN IEC112/ VDE 0303 part 1, group IIIa per DIN VDE 6110 175 399			175		399	
$V_{IOTM}$		$V_{IOTM}$	6000			V
$V_{IORM}$		$V_{IORM}$	707			V
Isolation resistance	$V_{IO} = 500 \text{ V}, T_{amb} = 25 \text{ }^\circ\text{C}$	$R_{IO}$			$\geq 10^{12}$	$\Omega$
	$V_{IO} = 500 \text{ V}, T_{amb} = 100 \text{ }^\circ\text{C}$	$R_{IO}$			$\geq 10^{11}$	$\Omega$
$P_{SO}$					350	mW
$I_{SI}$					150	mA
$T_{SI}$					165	$^\circ\text{C}$
Creepage distance			5			mm
Clearance distance			5			mm
Insulation thickness between emitter and detector			$\geq 0.4$			mm

**Note**

- As per IEC 60747-5-5, §7.4.3.8.1, this optocoupler is suitable for “safe electrical insulation” only within the safety ratings. Compliance with the safety ratings shall be ensured by means of protective circuits.

**TYPICAL CHARACTERISTICS** ( $T_{amb} = 25 \text{ }^\circ\text{C}$ , unless otherwise specified)

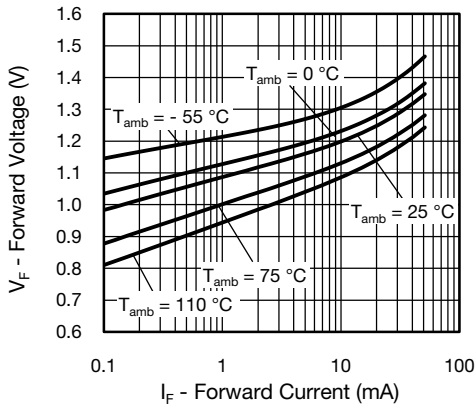

Fig. 3 - Forward Voltage vs. Forward Current

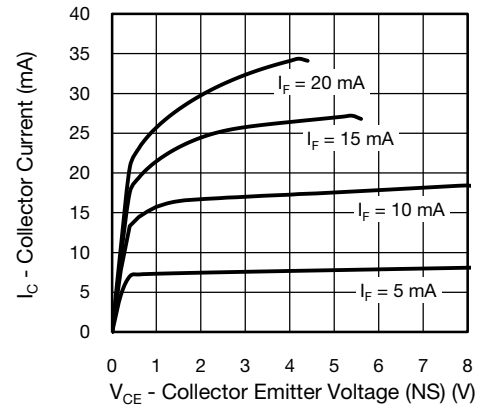

Fig. 4 - Collector Current vs. Collector Emitter Voltage (NS)

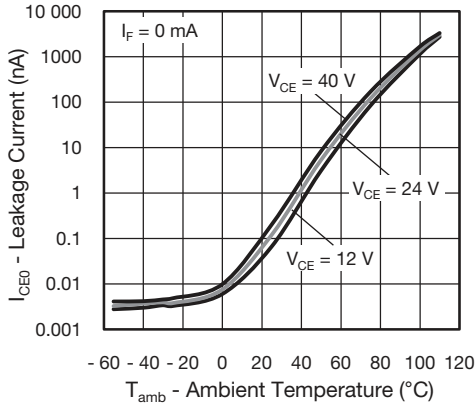

Fig. 5 - Leakage Current vs. Ambient Temperature

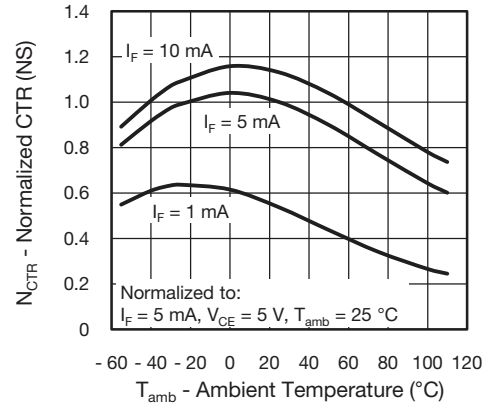

Fig. 8 - Normalized Current Transfer Ratio (NS) vs. Ambient Temperature

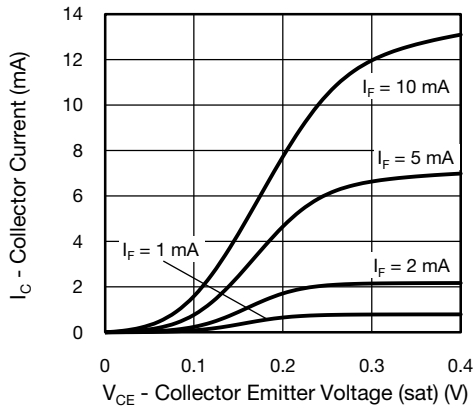

Fig. 6 - Collector Current vs. Collector Emitter Voltage (sat)

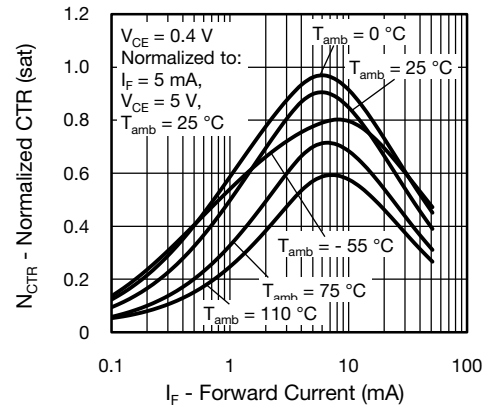

Fig. 9 - Normalized CTR (sat) vs. Forward Current

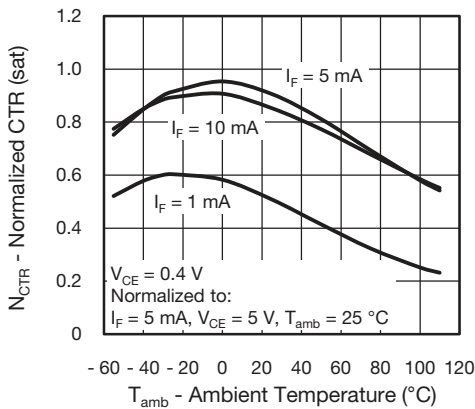

Fig. 7 - Normalized Current Transfer Ratio (sat) vs. Ambient Temperature

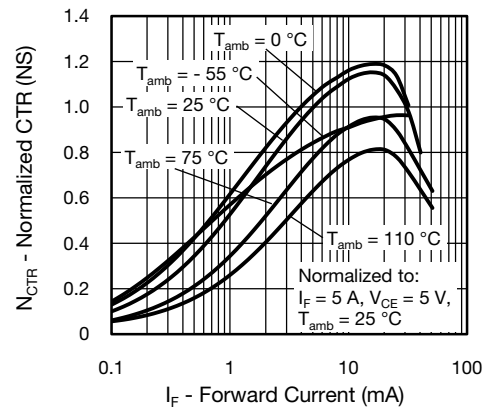

Fig. 10 - Normalized CTR (NS) vs. Forward Current

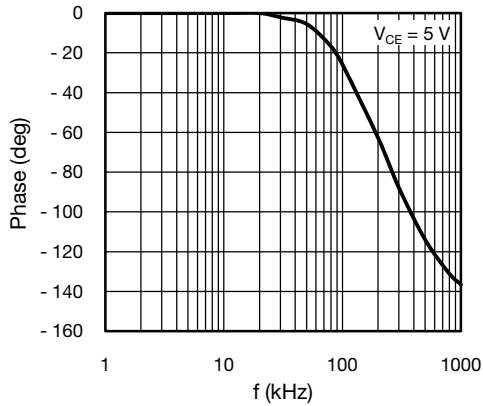

Fig. 11 -  $F_{CTR}$  vs. Phase Angle

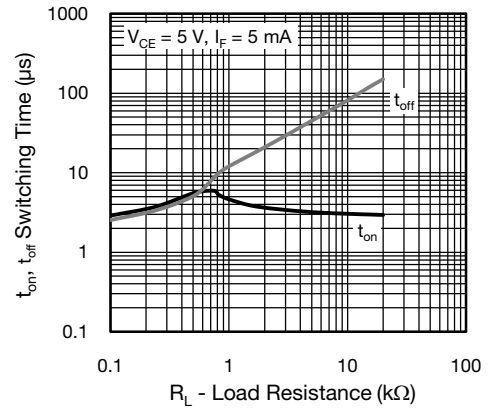

Fig. 13 - Switching Time vs. Load Resistance

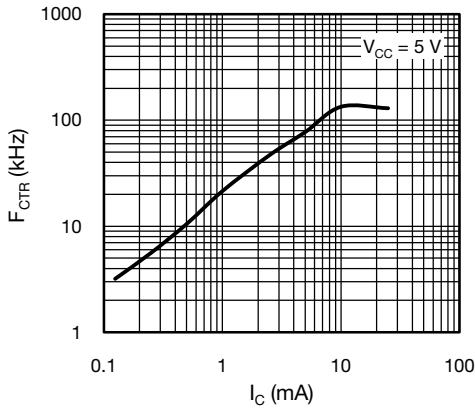
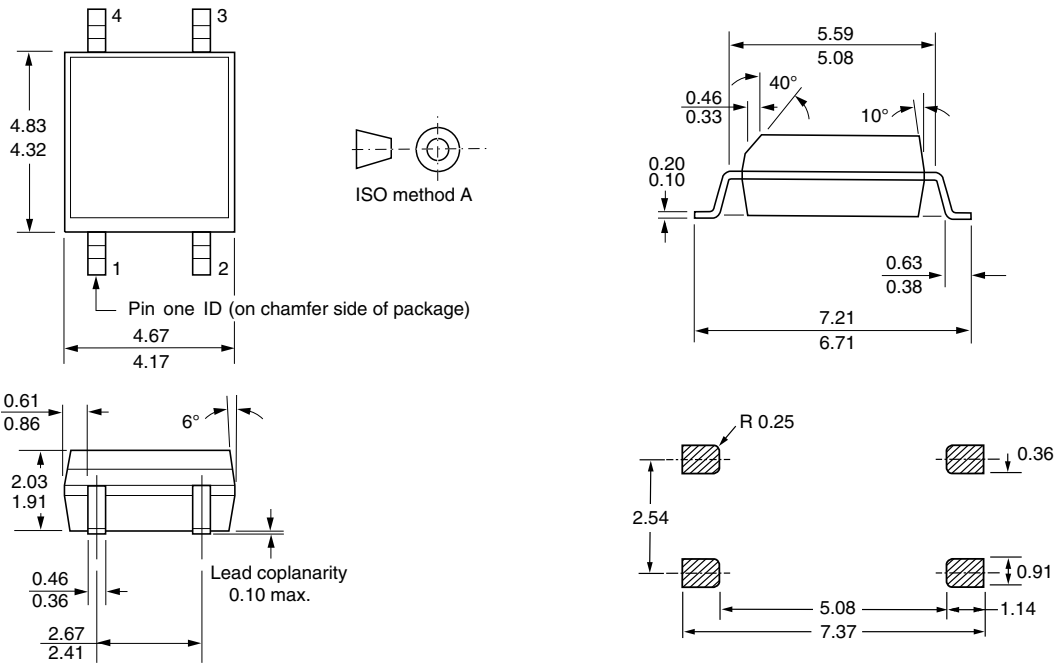

Fig. 12 -  $F_{CTR}$  vs. Collector Current



## PACKAGE DIMENSIONS in millimeters



i178037

## PACKAGE MARKING

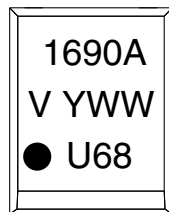

17944-4

(example for SFH1690AT)



17944-7

(example for SFH1690BT-X001)

### Notes

- The marking of the SFH1690ABT will either show 1690A or 1690B on the first line.
- Tape and reel suffix (T) is not part of the package marking.



## **Disclaimer**

ALL PRODUCT, PRODUCT SPECIFICATIONS AND DATA ARE SUBJECT TO CHANGE WITHOUT NOTICE TO IMPROVE RELIABILITY, FUNCTION OR DESIGN OR OTHERWISE.

Vishay Intertechnology, Inc., its affiliates, agents, and employees, and all persons acting on its or their behalf (collectively, "Vishay"), disclaim any and all liability for any errors, inaccuracies or incompleteness contained in any datasheet or in any other disclosure relating to any product.

Vishay makes no warranty, representation or guarantee regarding the suitability of the products for any particular purpose or the continuing production of any product. To the maximum extent permitted by applicable law, Vishay disclaims (i) any and all liability arising out of the application or use of any product, (ii) any and all liability, including without limitation special, consequential or incidental damages, and (iii) any and all implied warranties, including warranties of fitness for particular purpose, non-infringement and merchantability.

Statements regarding the suitability of products for certain types of applications are based on Vishay's knowledge of typical requirements that are often placed on Vishay products in generic applications. Such statements are not binding statements about the suitability of products for a particular application. It is the customer's responsibility to validate that a particular product with the properties described in the product specification is suitable for use in a particular application. Parameters provided in datasheets and / or specifications may vary in different applications and performance may vary over time. All operating parameters, including typical parameters, must be validated for each customer application by the customer's technical experts. Product specifications do not expand or otherwise modify Vishay's terms and conditions of purchase, including but not limited to the warranty expressed therein.

Except as expressly indicated in writing, Vishay products are not designed for use in medical, life-saving, or life-sustaining applications or for any other application in which the failure of the Vishay product could result in personal injury or death. Customers using or selling Vishay products not expressly indicated for use in such applications do so at their own risk. Please contact authorized Vishay personnel to obtain written terms and conditions regarding products designed for such applications.

No license, express or implied, by estoppel or otherwise, to any intellectual property rights is granted by this document or by any conduct of Vishay. Product names and markings noted herein may be trademarks of their respective owners.