

TPS82084 (2-A) / TPS82085 (3-A) High Efficiency Step-Down Converter MicroSiP™ Modules with Integrated Inductor

1 Features

- Low Profile MicroSiP™ Power Module
- DCS-control topology
- Up to 95% efficiency
- 17- μ A operating quiescent current
- -40°C to 125°C operating temperature range
- Hiccup short circuit protection
- 2.5-V to 6-V input voltage range
- 0.8-V to V_{IN} adjustable output voltage
- Power save mode for light load efficiency
- 100% duty cycle for lowest dropout
- Output discharge function
- Power good output
- Integrated soft startup, and support pre-biased startup
- Over temperature protection
- CISPR11 class B compliant
- 2.8-mm x 3.0-mm x 1.3-mm 8-Pin μ SiL package

2 Applications

- Optical module
- Single board computer
- Solid state drive
- Metro data center
- Audio/video control system
- Radar

3 Description

The TPS82084/5 are 2-A/3-A step-down converter MicroSiP™ modules optimized for small solution size and high efficiency. The power module integrates a synchronous step-down converter and an inductor to simplify design, reduce external components and save PCB area. The low profile and compact solution is suitable for automated assembly by standard surface mount equipment.

To maximize efficiency, the converter operates in PWM mode with a nominal switching frequency of 2.4MHz and automatically enters Power Save Mode operation at light load currents. In Power Save Mode, the device operates with typically 17- μ A quiescent current. Using the DCS-Control topology, the device achieves excellent load transient performance and accurate output voltage regulation. The EN and PG pins, which support sequencing configurations, bring a flexible system design. An integrated soft startup reduces the inrush current required from the input supply. Over temperature protection and Hiccup short circuit protection deliver a robust and reliable solution.

Device Information⁽¹⁾

PART NUMBER	PACKAGE	BODY SIZE (NOM)
TPS82085	μ SiL (8)	2.8 mm x 3.0 mm
TPS82084	μ SiL (8)	2.8 mm x 3.0 mm

Device Comparison

PART NUMBER	OUTPUT CURRENT
TPS82084	2 A
TPS82085	3 A

(1) For all available packages, see the orderable addendum at the end of the datasheet.

1.8 V Output Application

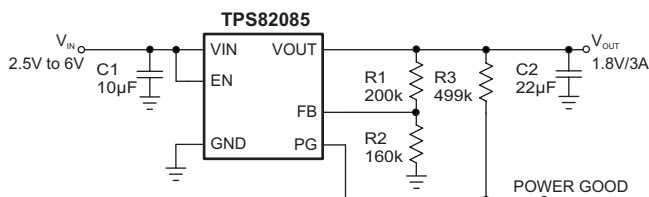

1.8 V Output Efficiency

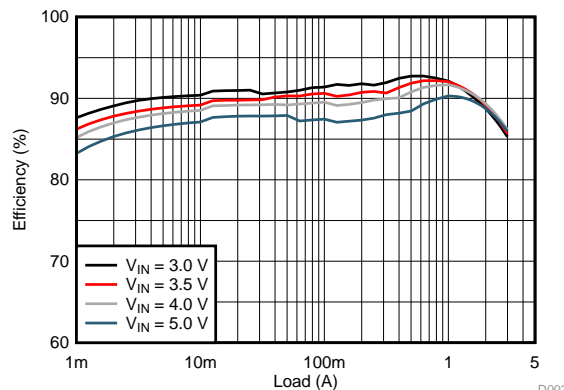

D002



Table of Contents

1 Features	1	8 Application and Implementation	10
2 Applications	1	8.1 Application Information.....	10
3 Description	1	8.2 Typical Applications	10
4 Revision History	2	9 Power Supply Recommendations	16
5 Pin Configuration and Functions	3	10 Layout	16
6 Specifications	3	10.1 Layout Guidelines	16
6.1 Absolute Maximum Ratings	3	10.2 Layout Example	16
6.2 ESD Ratings.....	3	10.3 Thermal Consideration.....	16
6.3 Recommend Operating Conditions.....	3	11 Device and Documentation Support	17
6.4 Thermal Information	4	11.1 Device Support.....	17
6.5 Electrical Characteristics.....	4	11.2 Related Links	17
6.6 Typical Characteristics	6	11.3 Community Resources.....	17
7 Detailed Description	7	11.4 Trademarks	17
7.1 Overview	7	11.5 Electrostatic Discharge Caution.....	17
7.2 Functional Block Diagram	7	11.6 Glossary	17
7.3 Feature Description.....	7	12 Mechanical, Packaging, and Orderable Information	17
7.4 Device Functional Modes.....	9	12.1 Tape and Reel Information	18

4 Revision History

Changes from Revision C (September 2018) to Revision D Page

- Correct the part number in the title
- Add the input voltage range for the output voltage discharge feature in [Enable and Disable](#).

Changes from Revision B (April 2015) to Revision C Page

- Added TPS82084 device into this data sheet
- Changed from –40 °C to –55 °C for storage temperature range
- Added thermal information for TPS82085EVM-672. Updated thermal metric value.
- Added power save mode waveform diagram to [Power Save Mode \(PSM\)](#)
- Added typical value of the EN pin high/low level input voltage in [Enable and Disable](#).....
- Added pg pin logic table in [Power Good Output](#)
- Added integrated inductor information in [Application Information](#)
- Added additional efficiency curves and a reference hyperlink to the BOM, [Table 3](#)
- Added radiated emission performance graph

Changes from Revision A (April 2015) to Revision B Page

- Changed the [ESD Ratings](#) Charged device model (CDM) From: ±500 V To: ±1000 V.....

Changes from Original (October 2014) to Revision A Page

- Changed the data sheet From: 3-page Product Preview To: Production data

5 Pin Configuration and Functions

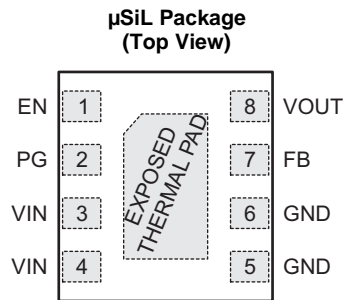

Pin Functions

PIN		I/O	DESCRIPTION
NAME	NO.		
EN	1	I	Enable pin. Pull High to enable the device. Pull Low to disable the device. This pin has an internal pull-down resistor of typically 400 kΩ when the device is disabled.
PG	2	O	Power good open drain output pin. A pull-up resistor can be connected to any voltage less than 6V. Leave it open if it is not used.
VIN	3,4	PWR	Input voltage pin.
GND	5,6		Ground pin.
FB	7	I	Feedback reference pin. An external resistor divider connected to this pin programs the output voltage.
VOUT	8	PWR	Output voltage pin.
Exposed Thermal Pad			The exposed thermal pad must be connected to the GND pin. Must be soldered to achieve appropriate power dissipation and mechanical reliability.

6 Specifications

6.1 Absolute Maximum Ratings⁽¹⁾

		MIN	MAX	UNIT
Voltage at pins ⁽²⁾	EN, PG, VIN, FB, VOUT	-0.3	7	V
Sink current	PG		1.0	mA
Module operating temperature range		-40	125	°C
Storage temperature range		-55	125	°C

(1) Stresses beyond those listed under absolute maximum ratings may cause permanent damage to the device. These are stress ratings only, and functional operation of the device at these or any other conditions beyond those indicated under recommended operating conditions is not implied. Exposure to absolute-maximum-rated conditions for extended periods may affect device reliability.

(2) All voltage values are with respect to network ground pin.

6.2 ESD Ratings

			VALUE	UNIT
V _(ESD)	Electrostatic discharge	Human body model (HBM), per ANSI/ESDA/JEDEC JS-001 ⁽¹⁾	±2000	V
		Charged device model (CDM), per JEDEC specification JESD22-C101 ⁽²⁾	±1000	

(1) JEDEC document JEP155 states that 500-V HBM allows safe manufacturing with a standard ESD control process.

(2) JEDEC document JEP157 states that 250-V CDM allows safe manufacturing with a standard ESD control process.

6.3 Recommend Operating Conditions

Over operating free-air temperature range, unless otherwise noted.

		MIN	MAX	UNIT
V _{IN}	Input voltage range	2.5	6	V
V _{PG}	Power good pull-up resistor voltage		6	V

Recommend Operating Conditions (continued)

Over operating free-air temperature range, unless otherwise noted.

		MIN	MAX	UNIT
V_{OUT}	Output voltage range	0.8	V_{IN}	V
I_{OUT}	Output current range, TPS82084 ⁽¹⁾	0	2	A
	Output current range, TPS82085 ⁽¹⁾	0	3	A
T_J	Module operating temperature range ⁽¹⁾	-40	125	°C

(1) The module operating temperature range includes module self temperature rise and IC junction temperature rise. In applications where high power dissipation is present, the maximum operating temperature or maximum output current must be derated.

6.4 Thermal Information

THERMAL METRIC ⁽¹⁾		TPS82084/5SIL (JEDEC 51-5)	TPS82085EVM-672	UNIT
$R_{\theta JA}$	Junction-to-ambient thermal resistance	64.6	46.6	°C/W
$R_{\theta JC(top)}$	Junction-to-case (top) thermal resistance	30.1	n/a ⁽²⁾	
$R_{\theta JB}$	Junction-to-board thermal resistance	23.5	n/a ⁽²⁾	
Ψ_{JT}	Junction-to-top characterization parameter	0.1	0.1	
Ψ_{JB}	Junction-to-board characterization parameter	23.3	24.6	
$R_{\theta JC(bot)}$	Junction-to-case (bottom) thermal resistance	17.2	15.4	

(1) For more information about traditional and new thermal metrics, see the IC Package Thermal Metrics application report, [SPRA953](#)

(2) Not applicable to an EVM

6.5 Electrical Characteristics

$T_J = -40^{\circ}\text{C}$ to 125°C and $V_{IN} = 2.5\text{V}$ to 6V . Typical values are at $T_J = 25^{\circ}\text{C}$ and $V_{IN} = 3.6\text{V}$, unless otherwise noted.

PARAMETER		TEST CONDITIONS	MIN	TYP	MAX	UNIT
SUPPLY						
V_{IN}	Input voltage range		2.5		6	V
I_Q	Quiescent current into V_{IN}	No load, device not switching $T_J = -40^{\circ}\text{C}$ to 85°C , $V_{IN} = 2.5\text{V}$ to 5.5V		17	25	μA
I_{SD}	Shutdown current into V_{IN}	EN = Low, $T_J = -40^{\circ}\text{C}$ to 85°C , $V_{IN} = 2.5\text{V}$ to 5.5V		0.7	5	μA
V_{UVLO}	Under voltage lock out threshold	V_{IN} falling	2.1	2.2	2.3	V
		V_{IN} rising	2.3	2.4	2.5	V
T_{JSD}	Thermal shutdown threshold	T_J rising		150		°C
	Thermal shutdown hysteresis	T_J falling		20		°C
LOGIC INTERFACE EN						
V_{IH}	High-level input voltage		1.0			V
V_{IL}	Low-level input voltage				0.4	V
$I_{lkg(EN)}$	Input leakage current into EN pin	EN = High		0.01	0.16	μA
R_{PD}	Pull-down resistance at EN pin	EN = Low		400		k Ω
SOFT START, POWER GOOD						
t_{SS}	Soft start time	Time from EN high to 95% of V_{OUT} nominal		0.8		ms
V_{PG}	Power good threshold	V_{OUT} rising, referenced to V_{OUT} nominal	93%	95%	98%	
		V_{OUT} falling, referenced to V_{OUT} nominal	88%	90%	93%	
$V_{PG,OL}$	Low-level output voltage	$I_{sink} = 1\text{mA}$			0.4	V
$I_{lkg(PG)}$	Input leakage current into PG pin	$V_{PG} = 5\text{V}$		0.01	0.16	μA

Electrical Characteristics (continued)

$T_J = -40^{\circ}\text{C}$ to 125°C and $V_{IN} = 2.5\text{V}$ to 6V . Typical values are at $T_J = 25^{\circ}\text{C}$ and $V_{IN} = 3.6\text{V}$, unless otherwise noted.

PARAMETER		TEST CONDITIONS	MIN	TYP	MAX	UNIT
OUTPUT						
V_{OUT}	Output voltage range		0.8		V_{IN}	V
V_{FB}	Feedback regulation voltage	PWM mode	792	800	808	mV
		PSM mode, $C_{OUT} = 22\ \mu\text{F}$	792	800	817	
$I_{lkg(FB)}$	Feedback input leakage current	$V_{FB} = 0.8\ \text{V}$		0.01	0.1	μA
R_{DIS}	Output discharge resistor	EN = Low, $V_{OUT} = 1.8\ \text{V}$		260		Ω
	Line regulation	$I_{OUT} = 1\ \text{A}$, $V_{IN} = 2.5\ \text{V}$ to $6\ \text{V}$		0.02		%/V
	Load regulation	$I_{OUT} = 0.5\ \text{A}$ to $3\ \text{A}$		0.16		%/A
POWER SWITCH						
$R_{DS(on)}$	High-side FET on-resistance	$I_{SW} = 500\ \text{mA}$		31	56	$\text{m}\Omega$
	Low-side FET on-resistance	$I_{SW} = 500\ \text{mA}$		23	45	$\text{m}\Omega$
R_{DP}	Dropout resistance	100% mode		69		$\text{m}\Omega$
I_{LIMF}	High-side FET switch current limit	TPS82085	3.7	4.6	5.5	A
		TPS82084		3.6		
f_{SW}	PWM switching frequency	$I_{OUT} = 1\ \text{A}$		2.4		MHz

6.6 Typical Characteristics

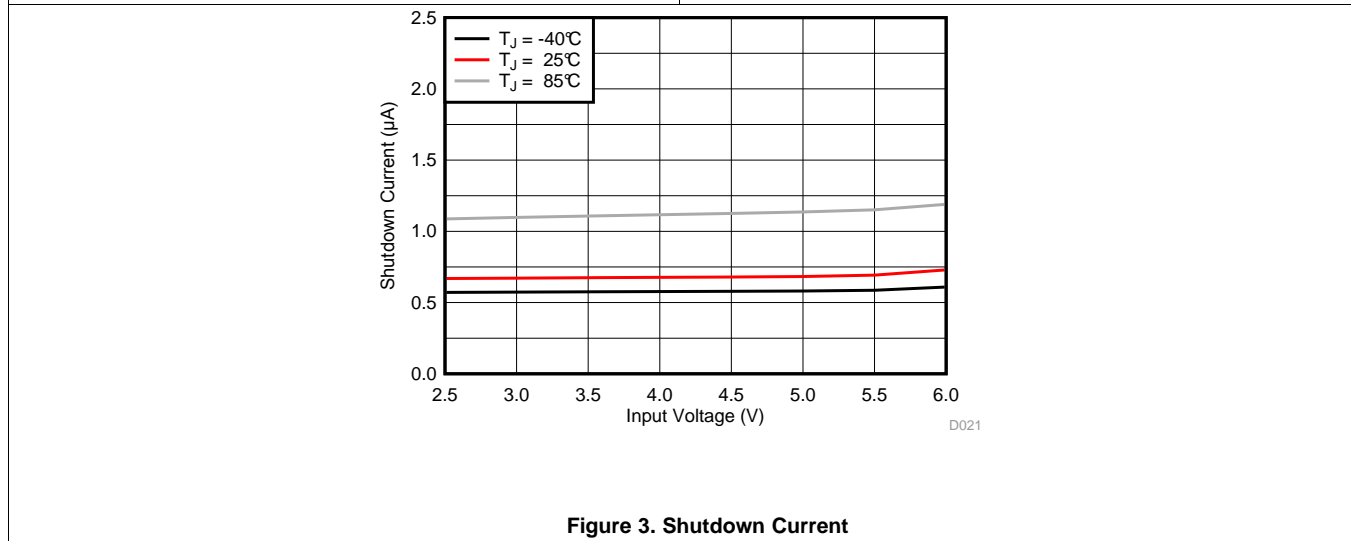
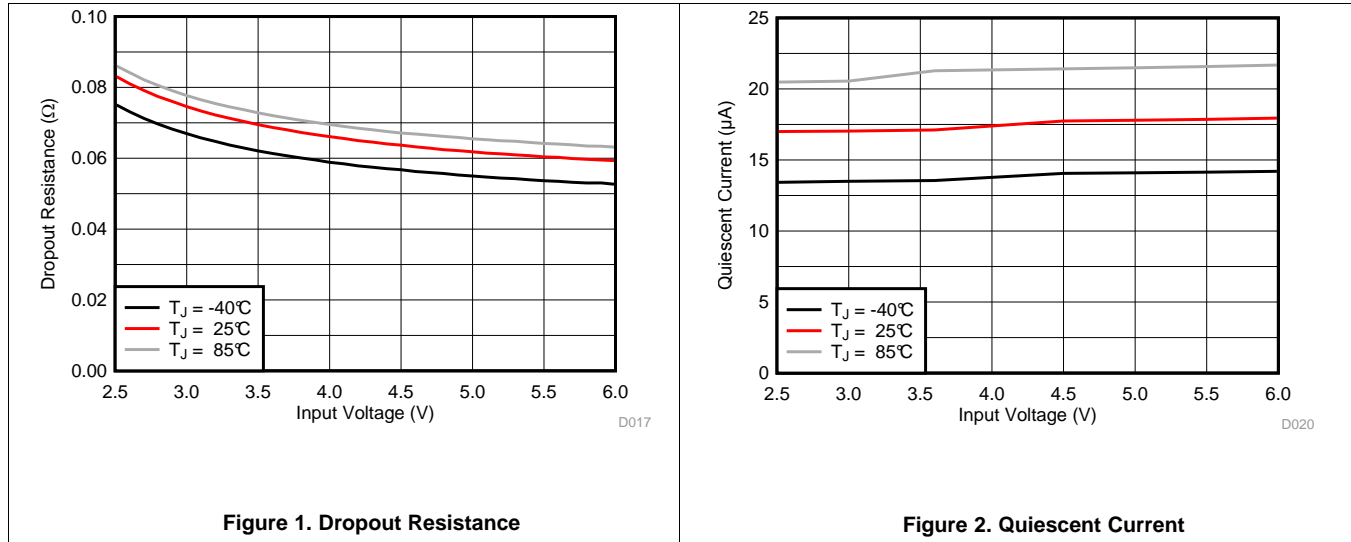

7 Detailed Description

7.1 Overview

The TPS82084/5 synchronous step-down converter power modules are based on DCS-Control™ (Direct Control with Seamless transition into Power Save Mode). This is an advanced regulation topology that combines the advantages of hysteretic, voltage and current mode control.

The DCS-Control™ topology operates in PWM (Pulse Width Modulation) mode for medium to heavy load conditions and in PSM (Power Save Mode) at light load currents. In PWM, the converter operates with its nominal switching frequency of 2.4 MHz having a controlled frequency variation over the input voltage range. As the load current decreases, the converter enters Power Save Mode, reducing the switching frequency and minimizing the IC's quiescent current to achieve high efficiency over the entire load current range. DCS-Control™ supports both operation modes using a single building block and therefore has a seamless transition from PWM to PSM without effects on the output voltage. The device offers excellent DC voltage regulation and load transient regulation, combined with low output voltage ripple, minimizing interference with RF circuits.

7.2 Functional Block Diagram

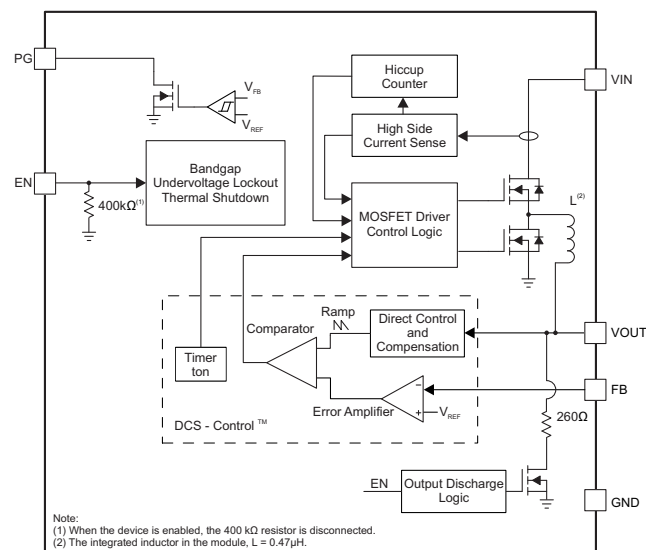

7.3 Feature Description

7.3.1 Power Save Mode (PSM)

The device includes a fixed on-time (t_{ON}) circuitry. This t_{ON} , in steady-state operation in PWM and PSM modes, is estimated as:

$$t_{ON} = 420 \text{ ns} \times \frac{V_{OUT}}{V_{IN}}$$

$$f_{PSM} = \frac{2 \times I_{OUT}}{t_{ON}^2 \times \frac{V_{IN}}{V_{OUT}} \times \frac{V_{IN} - V_{OUT}}{L}}$$
(1)

To maintain high efficiency at light loads, the device enters Power Save Mode seamlessly when the load current decreases. This happens when the load current becomes smaller than half the inductor's ripple current. In PSM, the converter operates with a reduced switching frequency and with a minimum quiescent current to maintain high efficiency. The on time in PSM is also based on the same t_{ON} circuitry. The switching frequency in PSM is shown in [Equation 1](#).

Feature Description (continued)

In PSM, the output voltage rises slightly above the nominal output voltage in PWM mode. This effect is reduced by increasing the output capacitance. The output voltage accuracy in PSM operation is reflected in the electrical specification table and given for a 22- μ F output capacitor.

During PAUSE period in PSM (shown in Figure 4), the device does not change the PG pin state nor does it detect an UVLO event, in order to achieve a minimum quiescent current and maintain high efficiency at light loads.

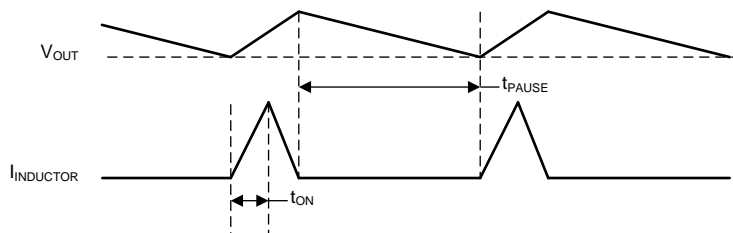

Figure 4. Power Save Mode Waveform Diagram

7.3.2 Low Dropout Operation (100% Duty Cycle)

The device offers a low input to output voltage differential by entering 100% duty cycle mode. In this mode, the high-side MOSFET switch is constantly turned on. This is particularly useful in battery powered applications to achieve longest operation time by taking full advantage of the whole battery voltage range. The minimum input voltage to maintain a minimum output voltage is given by:

$$V_{IN(min)} = V_{OUT(min)} + I_{OUT} \times R_{DP} \quad (2)$$

Where

R_{DP} = Resistance from V_{IN} to V_{OUT} , including high-side FET on-resistance and DC resistance of the inductor.

$V_{OUT(min)}$ = Minimum output voltage the load can accept.

7.3.3 Soft Startup

The device has an internal soft start circuit which ramps up the output voltage to the nominal voltage during a soft start time of typically 0.8ms. This avoids excessive inrush current and creates a smooth output voltage slope. It also prevents excessive voltage drops of primary cells and rechargeable batteries with high internal impedance. The device is able to monotonically start into a pre-biased output capacitor. The device starts with the applied bias voltage and ramps the output voltage to its nominal value.

7.3.4 Switch Current Limit and Short Circuit Protection (Hiccup-Mode)

The switch current limit prevents the device from high inductor current and from drawing excessive current from the battery or input voltage rail. Excessive current might occur with a heavy load/shorted output circuit condition. If the inductor peak current reaches the switch current limit, the high-side FET is turned off and the low-side FET is turned on to ramp down the inductor current. Once this switch current limit is triggered 32 times, the devices stop switching and enables the output discharge. The devices then automatically start a new startup after a typical delay time of 66 μ s has passed. This is named HICCUP short circuit protection. The devices repeat this mode until the high load condition disappears.

7.3.5 Undervoltage Lockout

To avoid mis-operation of the device at low input voltages, an under voltage lockout is implemented, which shuts down the devices at voltages lower than V_{UVLO} with a hysteresis of 200 mV.

7.3.6 Thermal Shutdown

The device goes into thermal shutdown and stops switching once the junction temperature exceeds T_{JSD} . Once the device temperature falls below the threshold by 20°C, the device returns to normal operation automatically.

7.4 Device Functional Modes

7.4.1 Enable and Disable

The device is enabled by setting the EN pin to a logic High (typical 0.8 V). Accordingly, shutdown mode is forced if the EN pin is pulled Low (typical 0.7 V) with a shutdown current of typically 0.7 μ A. An internal resistor of 260 Ω discharges the output via the VOUT pin smoothly when the device is disabled. The output discharge function also works when thermal shutdown, undervoltage lockout or short circuit protection are triggered. The output discharge function stops working when the input voltage has decreased to around 0.5V.

An internal pull-down resistor of 400 k Ω is connected to the EN pin when the EN pin is Low. The pull-down resistor is disconnected when the EN pin is High.

7.4.2 Power Good Output

The device has a power good (PG) output. The PG pin goes high impedance once the output is above 95% of the nominal voltage, and is driven low once the output voltage falls below typically 90% of the nominal voltage. The PG pin is an open drain output and is specified to sink up to 1 mA. The power good output requires a pull-up resistor connecting to any voltage rail less than 6 V.

The PG signal can be used for sequencing of multiple rails by connecting it to the EN pin of other converters. Leave the PG pin floating when it is not used. [Table 1](#) shows the PG pin logic.

Table 1. PG Pin Logic

	DEVICE CONDITIONS	LOGIC STATUS	
		HIGH Z	LOW
Enable	EN = High, $V_{FB} \geq V_{PG}$	√	
	EN = High, $V_{FB} < V_{PG}$		√
Shutdown	EN = Low		√
Thermal Shutdown	$T_J > T_{JSD}$		√
UVLO	$0.5\text{ V} < V_{IN} < V_{UVLO}$		√
Power Supply Removal	$V_{IN} \leq 0.5\text{ V}$	√	

8 Application and Implementation

NOTE

Information in the following applications sections is not part of the TI component specification, and TI does not warrant its accuracy or completeness. TI's customers are responsible for determining suitability of components for their purposes. Customers should validate and test their design implementation to confirm system functionality.

8.1 Application Information

The TPS82084/5 are synchronous step-down converter power modules whose output voltage is adjusted by component selection. The following section discusses the design of the external components to complete the power supply design for several input and output voltage options by using typical applications as a reference.

The required power inductor is integrated inside the TPS82084/5. The inductor is shielded and has an inductance of 0.47 μ H with approximately a +/- 20% tolerance. The TPS82084 and TPS82085 are pin-to-pin and BOM-to-BOM compatible, differing only in their rated output current.

8.2 Typical Applications

8.2.1 1.2-V Output Application

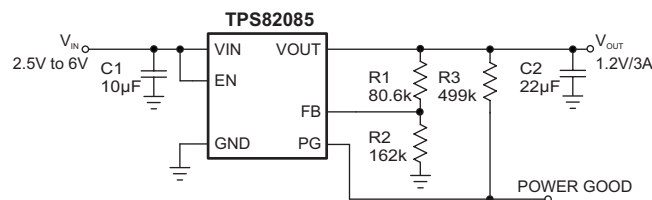

Figure 5. 1.2-V Output Application

8.2.1.1 Design Requirements

For this design example, use the input parameters shown in Table 2.

Table 2. Design Parameters

DESIGN PARAMETER	EXAMPLE VALUE
Input voltage range	2.5 V to 6 V
Output voltage	1.2 V
Output ripple voltage	< 20 mV
Output current rating	3 A

Table 3 lists the components used for the example.

Table 3. List of Components

REFERENCE	DESCRIPTION	MANUFACTURER
C1	10 μ F, Ceramic Capacitor, 10V, X7R, size 0805, GRM21BR71A106KE51	Murata
C2	22 μ F, Ceramic Capacitor, 6.3V, X7R, size 0805, CL21B226MQQNNNE or 22 μ F, Ceramic Capacitor, 6.3V, X7S, size 0805, C2012X7S1A226M125AC	Samsung or TDK
R1	Depending on the output voltage, 1% accuracy	Std
R2	162k Ω , 1% accuracy	Std
R3	499k Ω , 1% accuracy	Std

8.2.1.2 Detailed Design Procedure

8.2.1.2.1 Setting the Output Voltage

The output voltage is set by an external resistor divider according to the following equations:

$$V_{\text{OUT}} = V_{\text{FB}} \times \left(1 + \frac{R1}{R2} \right) = 0.8 \text{ V} \times \left(1 + \frac{R1}{R2} \right) \quad (3)$$

R2 should not be higher than 180 kΩ to achieve high efficiency at light load while providing acceptable noise sensitivity. Larger currents through R2 improve noise sensitivity and output voltage accuracy. [Figure 5](#) shows a recommended external resistor divider value for a 1.2-V output. Choose appropriate resistor values for other output voltages.

8.2.1.2.2 Input and Output Capacitor Selection

For best output and input voltage filtering, ceramic capacitors are required. The input capacitor minimizes input voltage ripple, suppresses input voltage spikes and provides a stable system rail for the device. A 10-μF or larger input capacitor is required. The output capacitor value can range from 22 μF up to more than 150 μF. The recommended typical output capacitor value is 22μF. Values over 150 μF may be possible with a reduced load during startup in order to avoid triggering the Hiccup short circuit protection. A feed forward capacitor is not required for proper operation.

Ceramic capacitor has a DC-Bias effect, which has a strong influence on the final effective capacitance. Choose the right capacitor carefully in combination with considering its package size and voltage rating. Ensure that the input effective capacitance is at least 5μF and the output effective capacitance is at least 8μF.

8.2.1.3 Application Performance Curves

$T_A = 25^\circ\text{C}$, $V_{IN} = 5\text{ V}$, $V_{OUT} = 1.2\text{ V}$, BOM = [Table 3](#) unless otherwise noted.

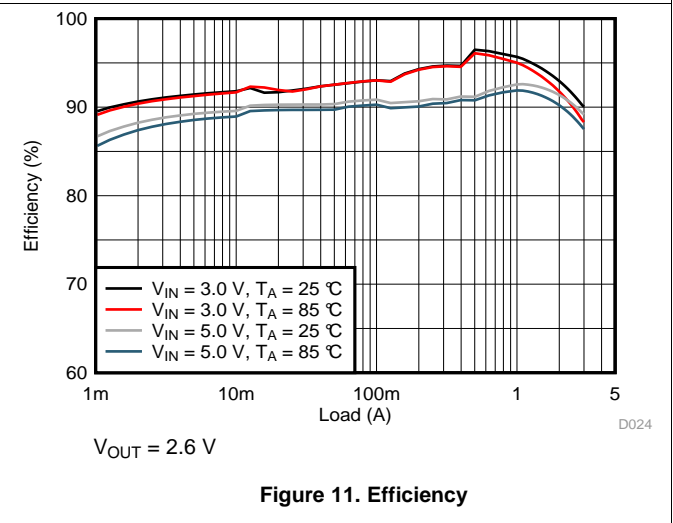
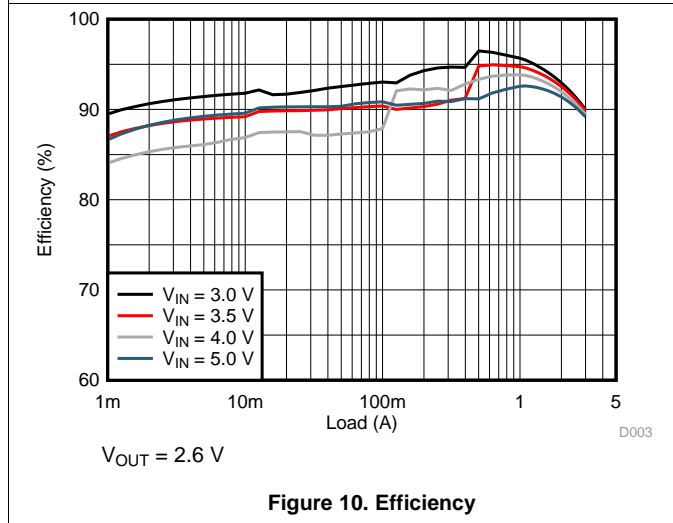
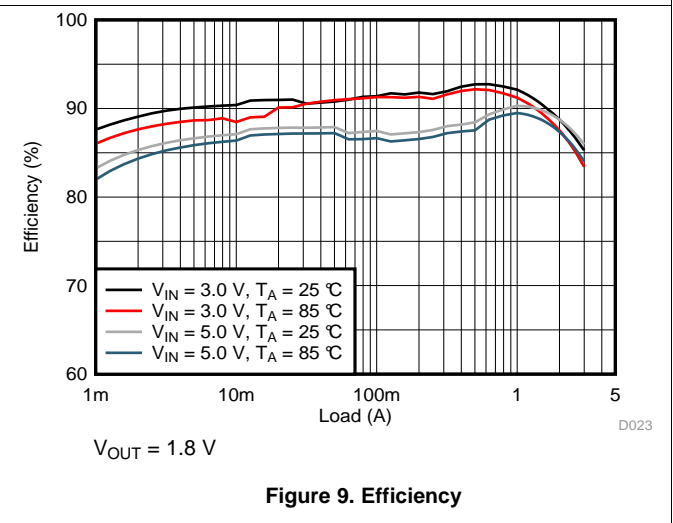
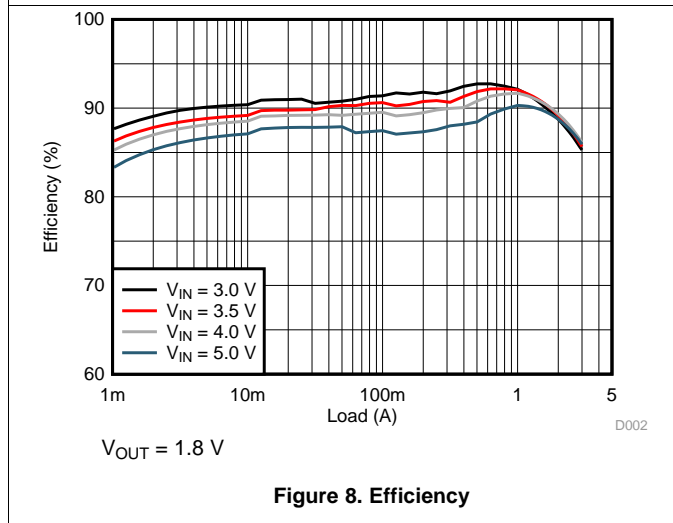
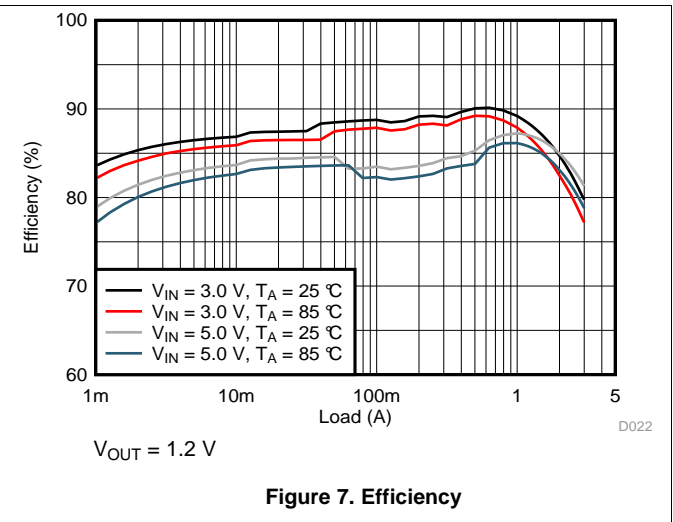
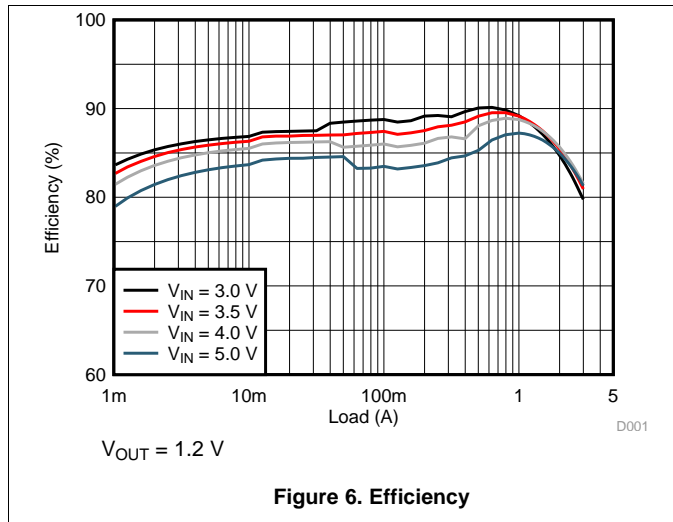

$T_A = 25^\circ\text{C}$, $V_{IN} = 5\text{ V}$, $V_{OUT} = 1.2\text{ V}$, BOM = Table 3 unless otherwise noted.

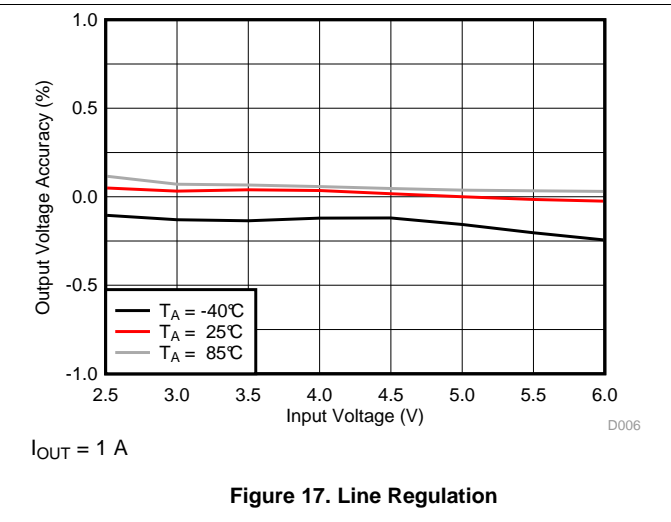
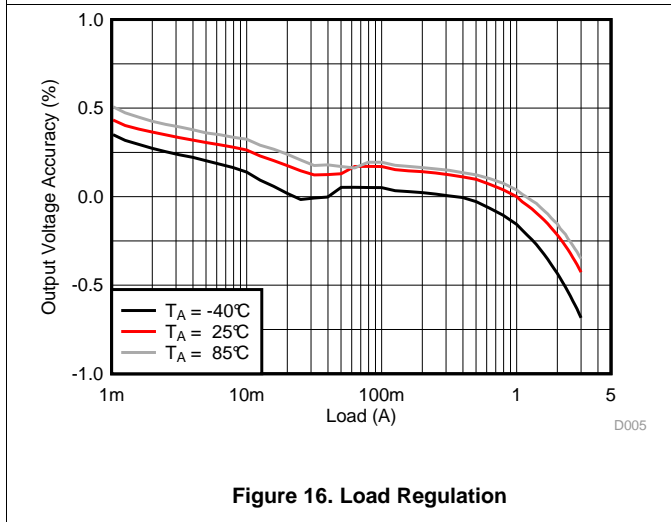
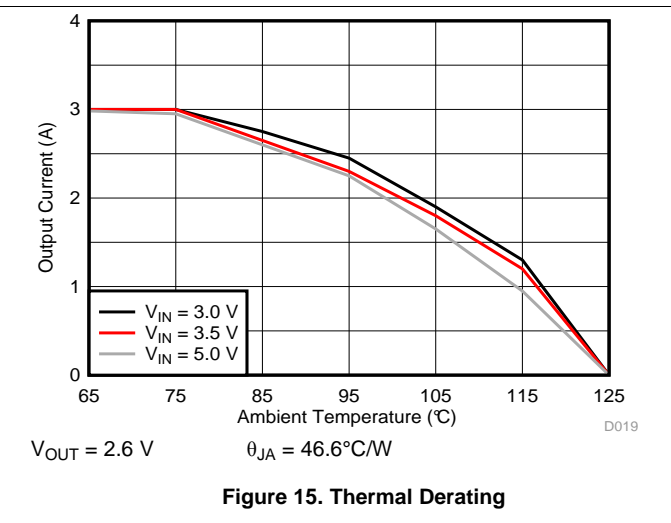
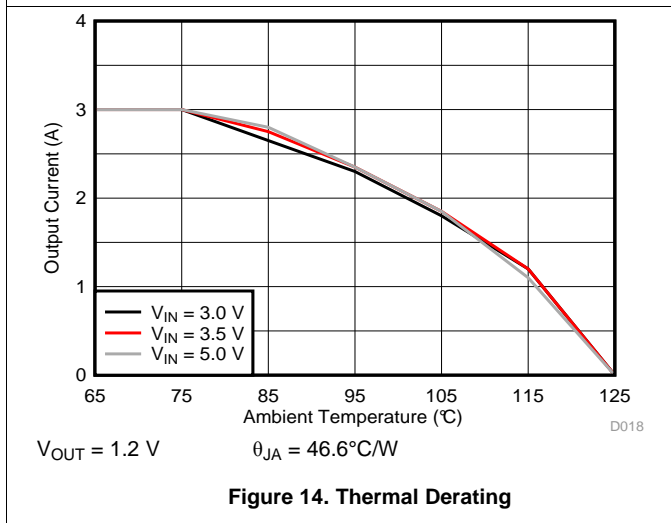
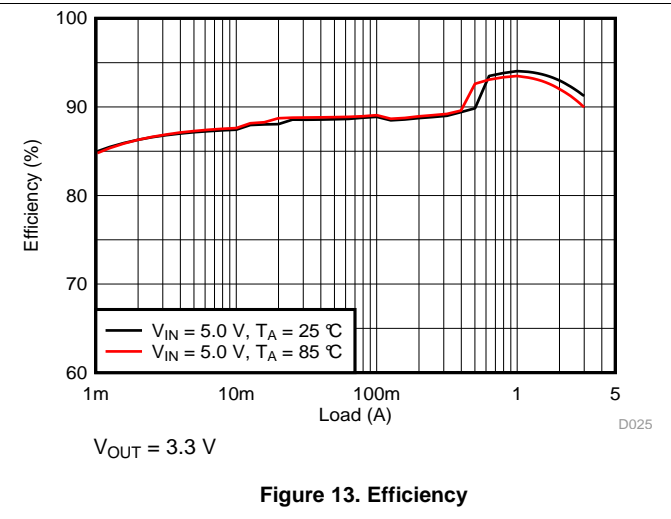
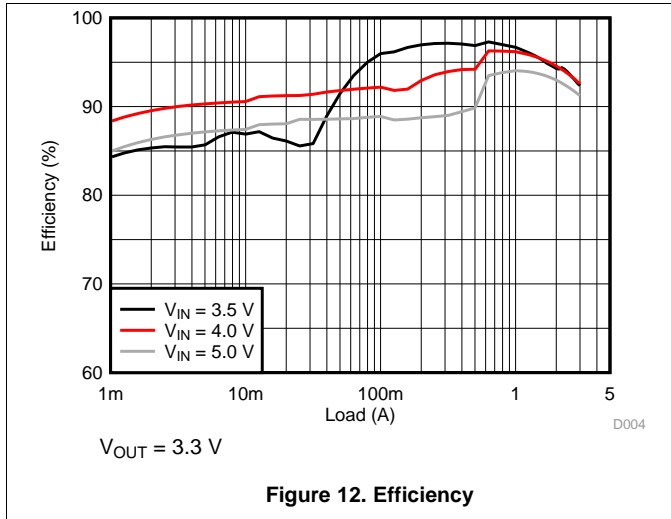

$T_A = 25^\circ\text{C}$, $V_{IN} = 5\text{ V}$, $V_{OUT} = 1.2\text{ V}$, BOM = [Table 3](#) unless otherwise noted.

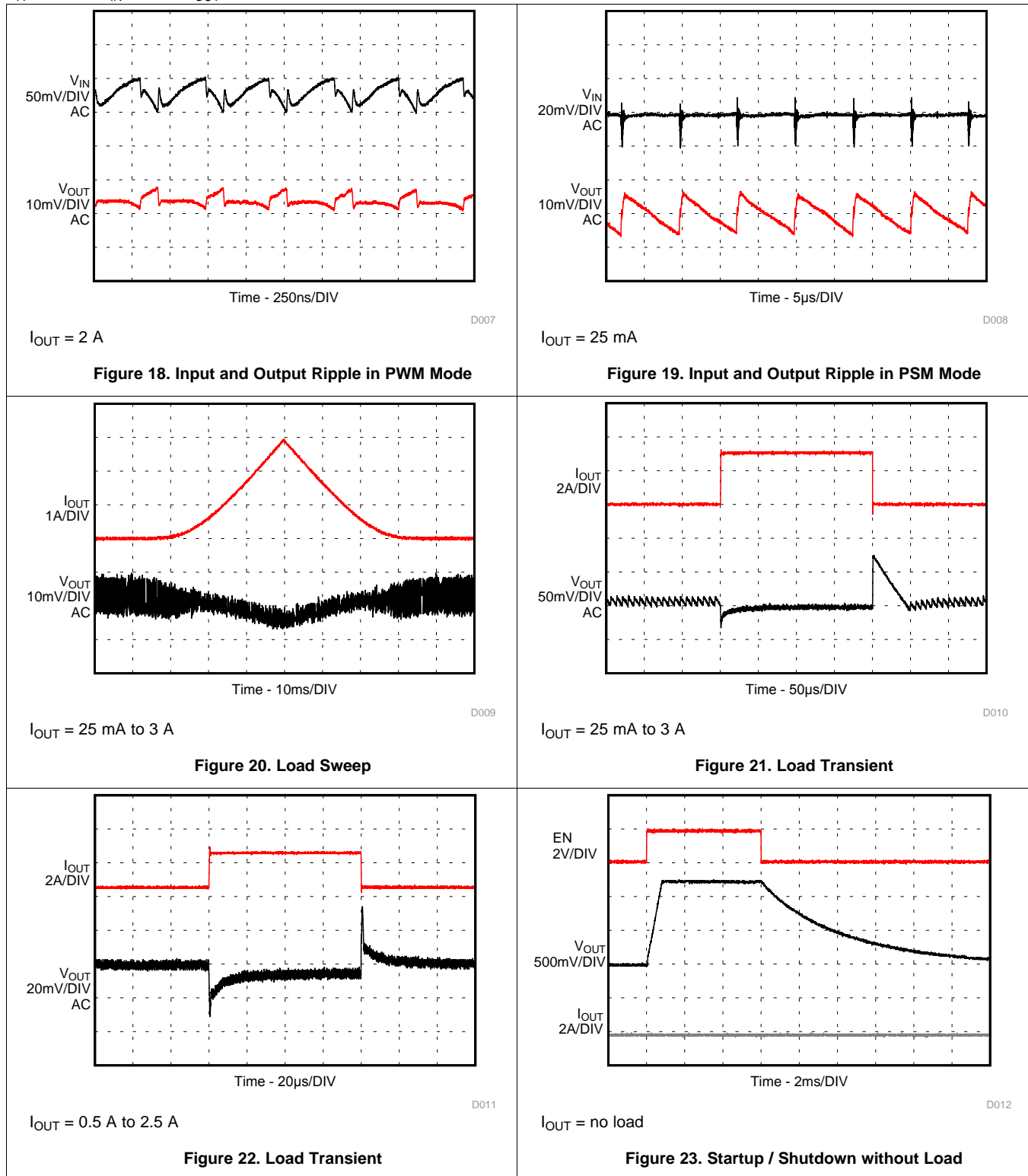

$T_A = 25^\circ\text{C}$, $V_{IN} = 5\text{ V}$, $V_{OUT} = 1.2\text{ V}$, BOM = Table 3 unless otherwise noted.

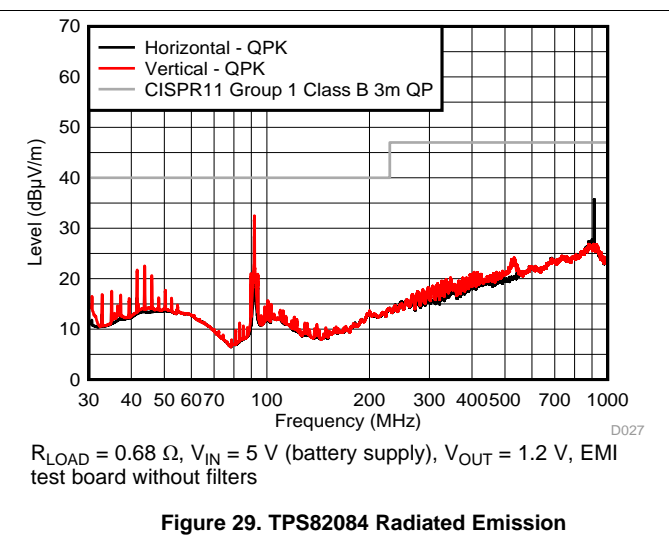
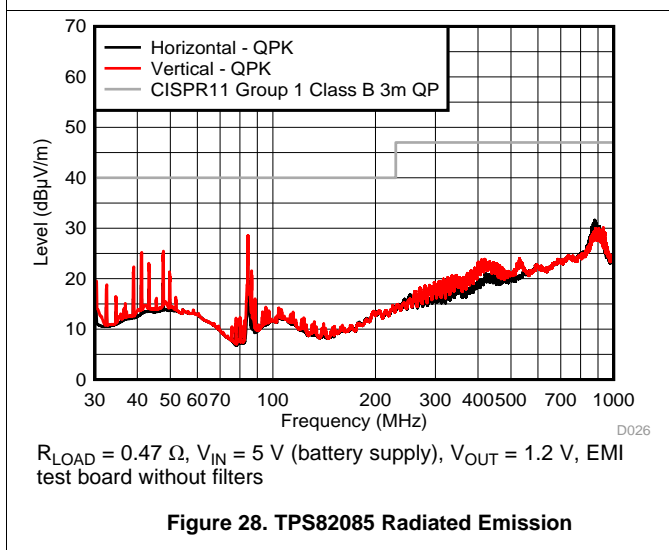
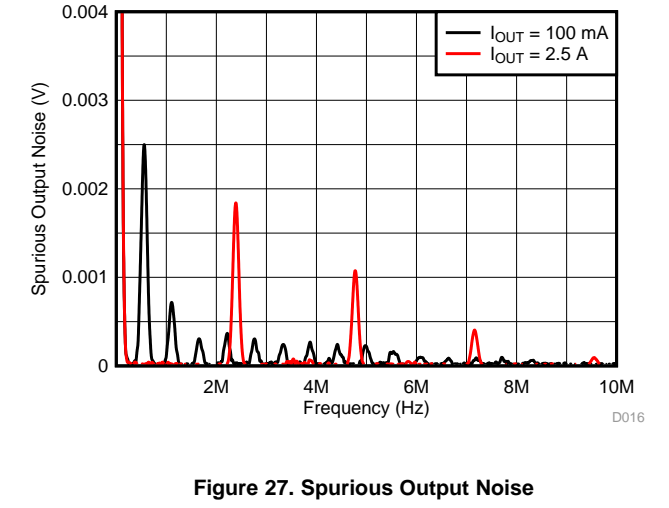
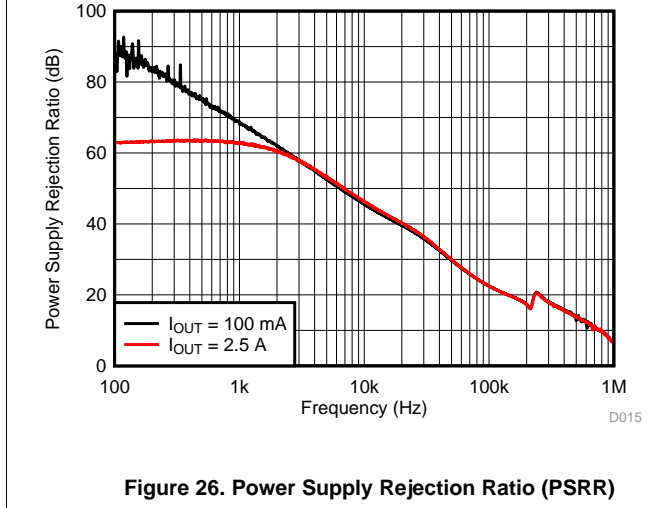
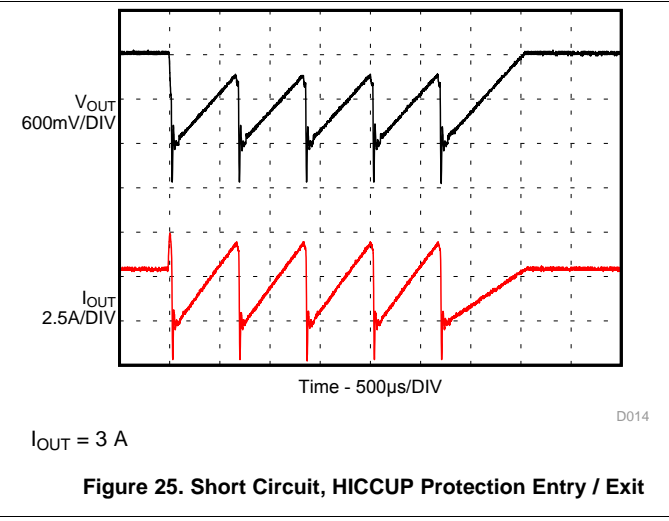
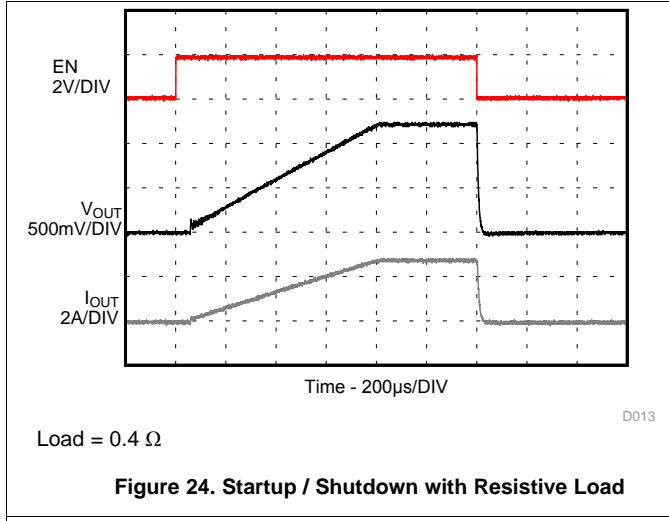

9 Power Supply Recommendations

The devices are designed to operate from an input supply voltage range between 2.5 V and 6 V. The average input current of the TPS82084/5 is calculated as:

$$I_{IN} = \frac{1}{\eta} \times \frac{V_{OUT} \times I_{OUT}}{V_{IN}} \quad (4)$$

Ensure that the power supply has a sufficient current rating for the application.

10 Layout

10.1 Layout Guidelines

- It is recommended to place all components as close as possible to the IC. Specially, the input capacitor placement must be closest to the VIN and GND pins of the device.
- Use wide and short traces for the main current paths to reduce the parasitic inductance and resistance.
- To enhance heat dissipation of the device, the exposed thermal pad should be connected to bottom or internal layer ground planes using vias.
- Refer to [Figure 30](#) for an example of component placement, routing and thermal design.
- The recommended land pattern for the TPS82084/5 is shown at the end of this data sheet. For best manufacturing results, it is important to create the pads as solder mask defined (SMD). This keeps each pad the same size and avoids solder pulling the device during reflow.

10.2 Layout Example

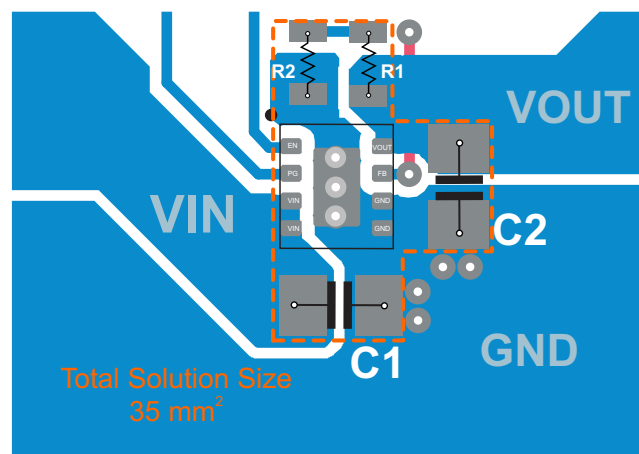

Figure 30. TPS82084/5 PCB Layout

10.3 Thermal Consideration

The TPS82084/5's output current needs to be derated when the device operates in a high ambient temperature or deliver high output power. The amount of current derated is dependent upon the input voltage, output power, PCB layout design and environmental thermal condition.

The TPS82084/5 module temperature must be kept less than the maximum rating of 125°C. Three basic approaches for enhancing thermal performance are listed below:

- Improve the power dissipation capability of the PCB design.
- Improve the thermal coupling of the component to the PCB.
- Introduce airflow into the system.

To estimate approximate module temperature of TPS82084/5, apply the typical efficiency stated in this datasheet to the desired application condition for the module power dissipation, then calculate the module temperature rise by multiplying the power dissipation by its thermal resistance. For more details on how to use the thermal parameters in real applications, see the application notes: [SZZA017](#) and [SPRA953](#).

11 Device and Documentation Support

11.1 Device Support

11.1.1 Third-Party Products Disclaimer

TI'S PUBLICATION OF INFORMATION REGARDING THIRD-PARTY PRODUCTS OR SERVICES DOES NOT CONSTITUTE AN ENDORSEMENT REGARDING THE SUITABILITY OF SUCH PRODUCTS OR SERVICES OR A WARRANTY, REPRESENTATION OR ENDORSEMENT OF SUCH PRODUCTS OR SERVICES, EITHER ALONE OR IN COMBINATION WITH ANY TI PRODUCT OR SERVICE.

11.2 Related Links

The table below lists quick access links. Categories include technical documents, support and community resources, tools and software, and quick access to order now.

Table 4. Related Links

PARTS	PRODUCT FOLDER	ORDER NOW	TECHNICAL DOCUMENTS	TOOLS & SOFTWARE	SUPPORT & COMMUNITY
TPS82085	Click here	Click here	Click here	Click here	Click here
TPS82084	Click here	Click here	Click here	Click here	Click here

11.3 Community Resources

The following links connect to TI community resources. Linked contents are provided "AS IS" by the respective contributors. They do not constitute TI specifications and do not necessarily reflect TI's views; see TI's [Terms of Use](#).

TI E2E™ Online Community *TI's Engineer-to-Engineer (E2E) Community*. Created to foster collaboration among engineers. At e2e.ti.com, you can ask questions, share knowledge, explore ideas and help solve problems with fellow engineers.

Design Support *TI's Design Support* Quickly find helpful E2E forums along with design support tools and contact information for technical support.

11.4 Trademarks

MicroSiP, DCS-Control, E2E are trademarks of Texas Instruments.

11.5 Electrostatic Discharge Caution



These devices have limited built-in ESD protection. The leads should be shorted together or the device placed in conductive foam during storage or handling to prevent electrostatic damage to the MOS gates.

11.6 Glossary

SLYZ022 — *TI Glossary*.

This glossary lists and explains terms, acronyms, and definitions.

12 Mechanical, Packaging, and Orderable Information

The following pages include mechanical, packaging, and orderable information. This information is the most current data available for the designated devices. This data is subject to change without notice and revision of this document. For browser-based versions of this data sheet, refer to the left-hand navigation.

12.1 Tape and Reel Information

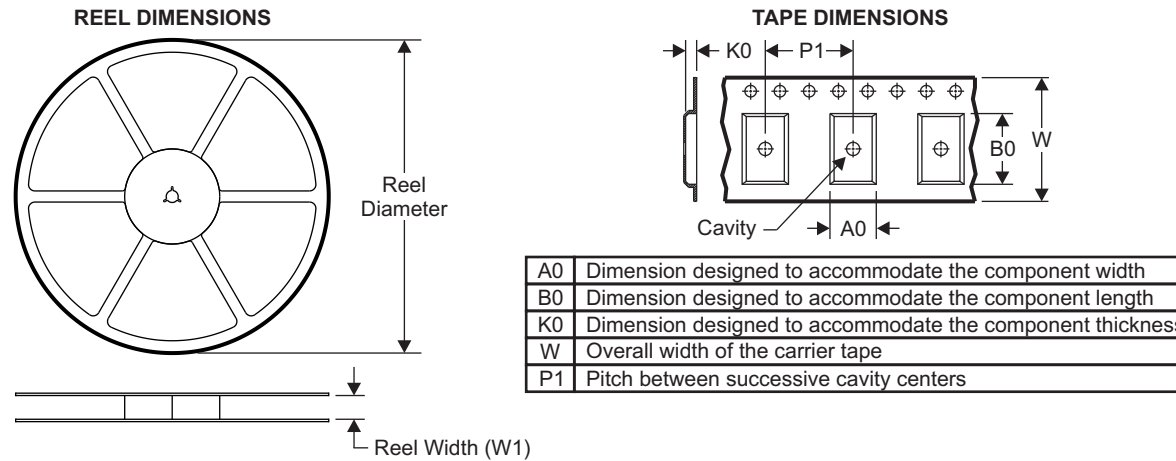

QUADRANT ASSIGNMENTS FOR PIN 1 ORIENTATION IN TAPE

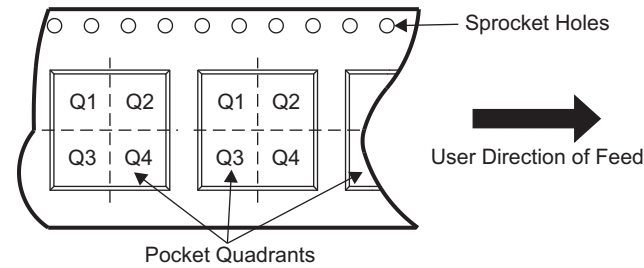

Device	Package Type	Package Drawing	Pins	SPQ	Reel Diameter (mm)	Reel Width W1 (mm)	A0 (mm)	B0 (mm)	K0 (mm)	P1 (mm)	W (mm)	Pin1 Quadrant
TPS82084SILR	uSiP	SIL	8	3000	330.0	12.4	3.0	3.2	1.45	4.0	12.0	Q1
TPS82084SILT	uSiP	SIL	8	250	178.0	13.2	3.0	3.2	1.45	4.0	12.0	Q1
TPS82085SILR	uSiP	SIL	8	3000	330.0	12.4	3.0	3.2	1.45	4.0	12.0	Q1
TPS82085SILT	uSiP	SIL	8	250	178.0	13.2	3.0	3.2	1.45	4.0	12.0	Q1

TAPE AND REEL BOX DIMENSIONS

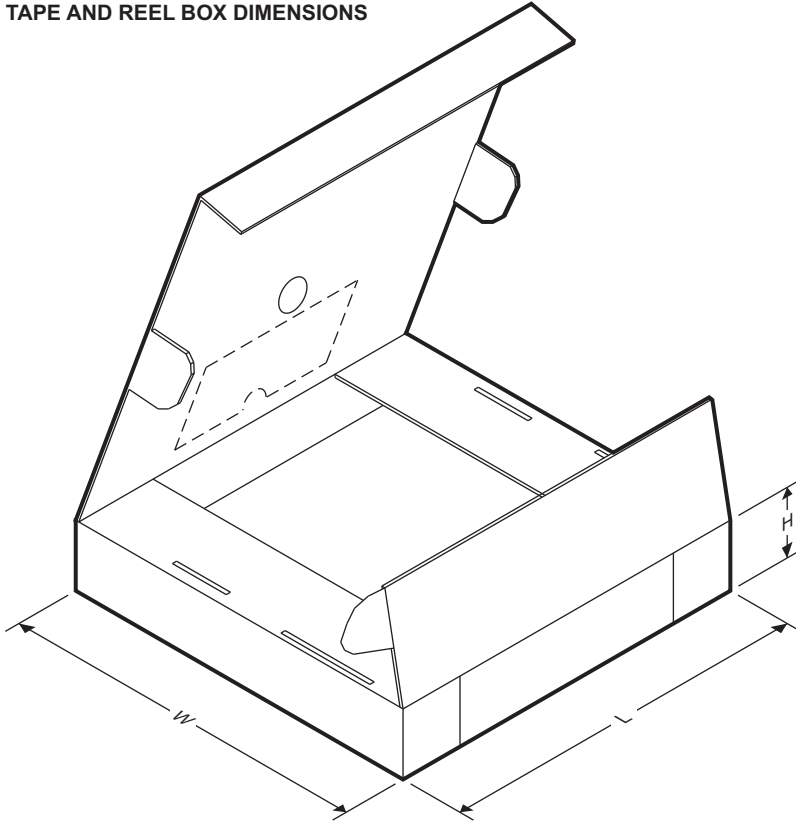

Device	Package Type	Package Drawing	Pins	SPQ	Length (mm)	Width (mm)	Height (mm)
TPS82084SILR	uSiP	SIL	8	3000	383	353	58
TPS82084SILT	uSiP	SIL	8	250	223	194	35
TPS82085SILR	uSiP	SIL	8	3000	383	353	58
TPS82085SILT	uSiP	SIL	8	250	223	194	35

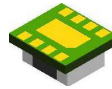

PACKAGE OUTLINE

SIL0008C

MicroSiP™ - 1.33 mm max height

MICRO SYSTEM IN PACKAGE

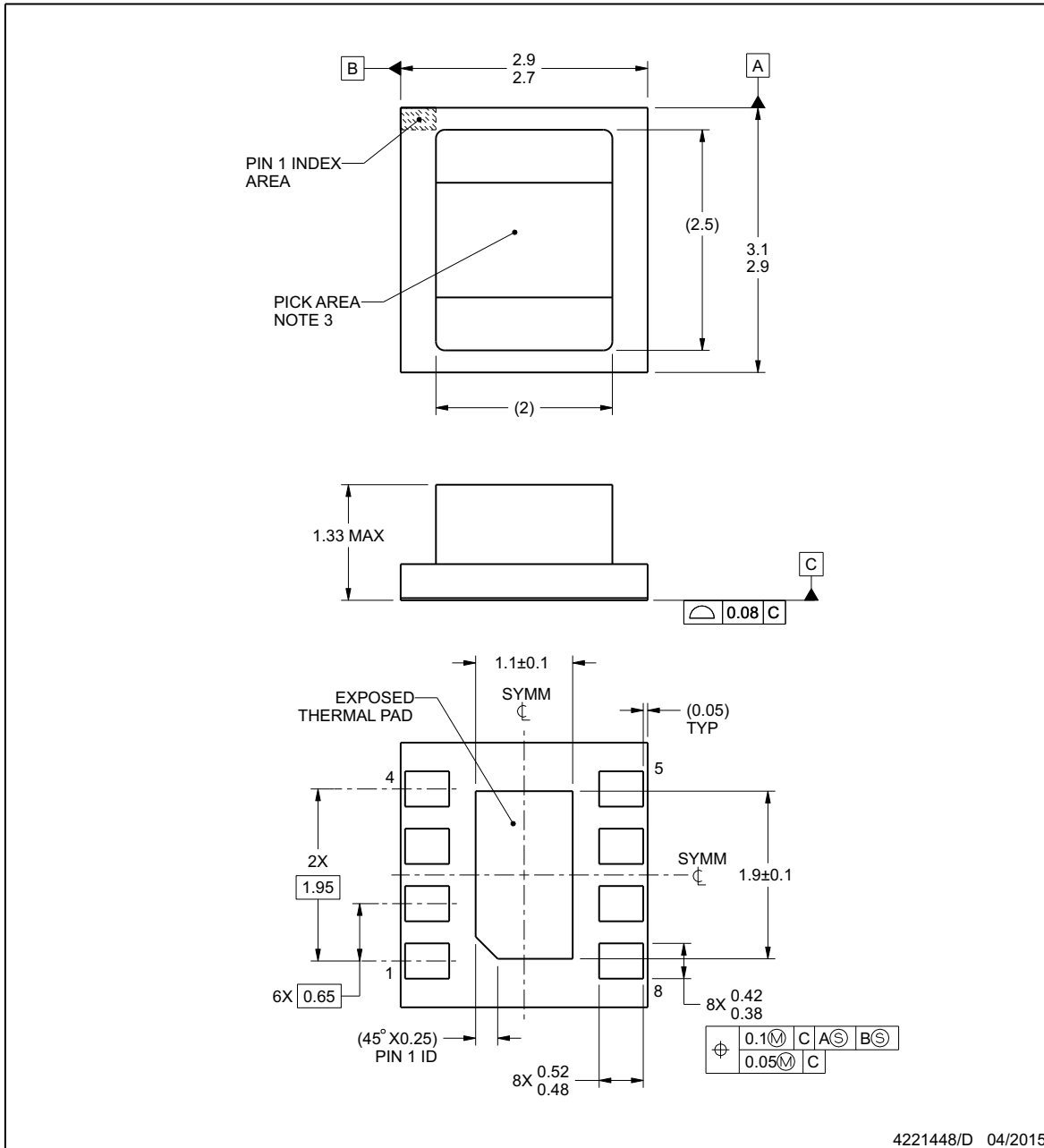

MicroSiP is a trademark of Texas Instruments

NOTES:

1. All linear dimensions are in millimeters. Any dimensions in parenthesis are for reference only. Dimensioning and tolerancing per ASME Y14.5M.
2. This drawing is subject to change without notice.
3. Pick and place nozzle \varnothing 1.3 mm or smaller recommended.
4. The package thermal pad must be soldered to the printed circuit board for thermal and mechanical performance.

EXAMPLE BOARD LAYOUT

SIL0008C

MicroSiP™ - 1.33 mm max height

MICRO SYSTEM IN PACKAGE

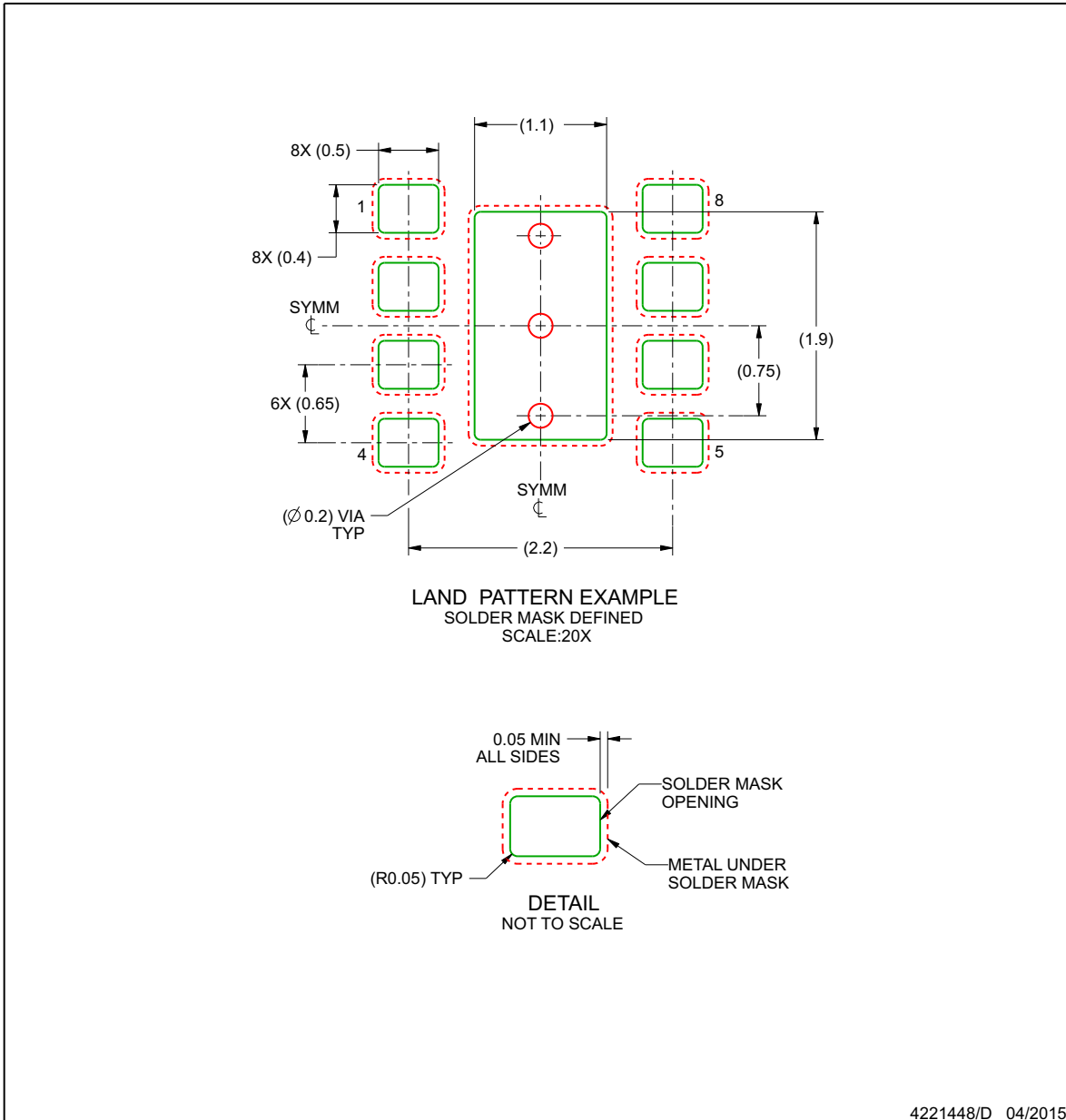

NOTES: (continued)

5. This package is designed to be soldered to a thermal pad on the board. For more information, see Texas Instruments literature number SLUA271 (www.ti.com/lit/slua271).

EXAMPLE STENCIL DESIGN

SIL0008C

MicroSiP™ - 1.33 mm max height

MICRO SYSTEM IN PACKAGE

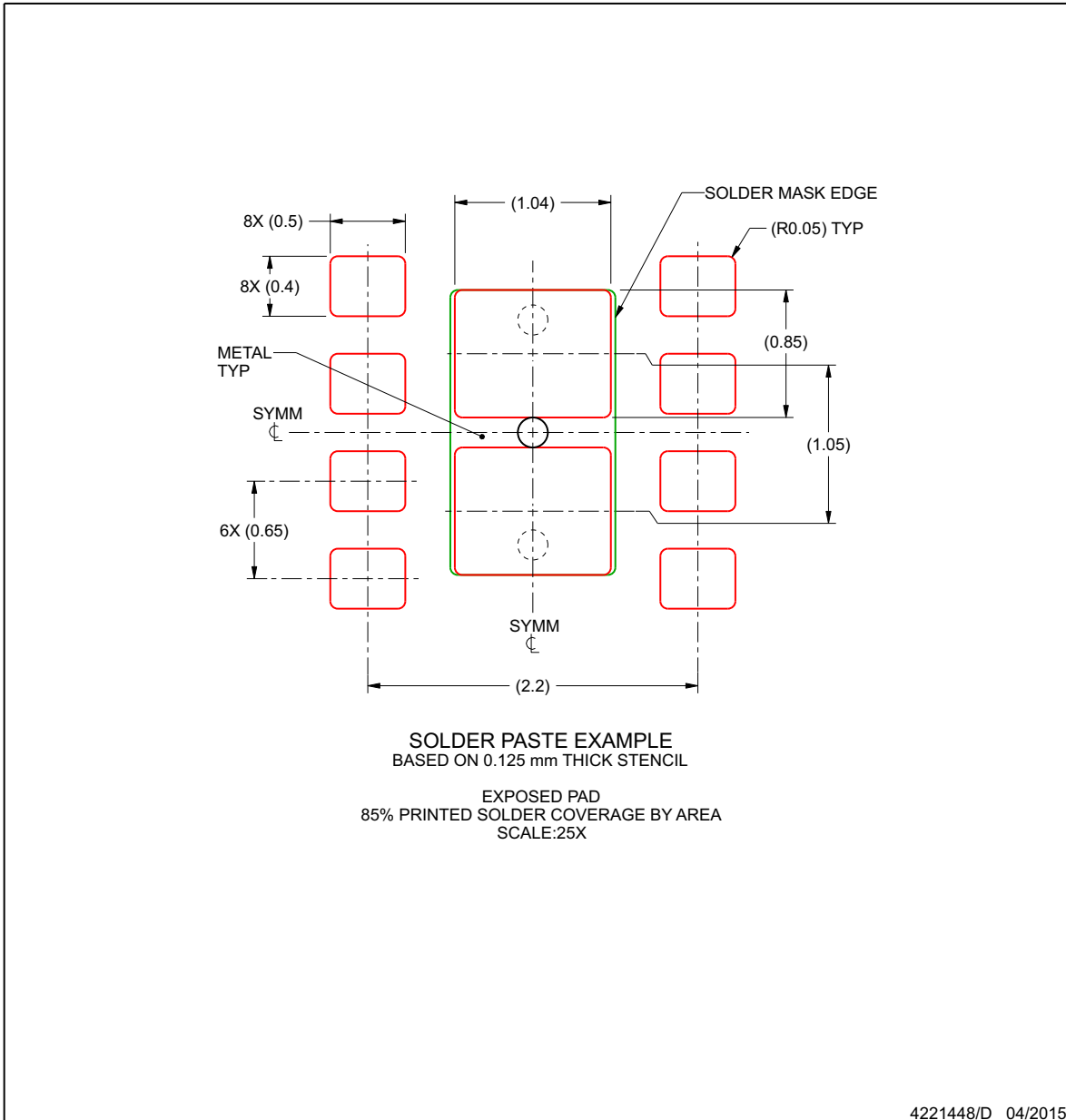

NOTES: (continued)

- 6. Laser cutting apertures with trapezoidal walls and rounded corners may offer better paste release. IPC-7525 may have alternate design recommendations.

PACKAGING INFORMATION

Orderable Device	Status (1)	Package Type	Package Drawing	Pins	Package Qty	Eco Plan (2)	Lead/Ball Finish (6)	MSL Peak Temp (3)	Op Temp (°C)	Device Marking (4/5)	Samples
TPS82084SILR	ACTIVE	uSiP	SIL	8	3000	RoHS & Green	NIAU	Level-2-260C-1 YEAR	-40 to 125	1D TXI084*EC	Samples
TPS82084SILT	ACTIVE	uSiP	SIL	8	250	RoHS & Green	NIAU	Level-2-260C-1 YEAR	-40 to 125	1D TXI084*EC	Samples
TPS82085SILR	ACTIVE	uSiP	SIL	8	3000	RoHS & Green	NIAU	Level-2-260C-1 YEAR	-40 to 125	GE TXI085*EC	Samples
TPS82085SILT	ACTIVE	uSiP	SIL	8	250	RoHS & Green	NIAU	Level-2-260C-1 YEAR	-40 to 125	GE TXI085*EC	Samples

(1) The marketing status values are defined as follows:

ACTIVE: Product device recommended for new designs.

LIFEBUY: TI has announced that the device will be discontinued, and a lifetime-buy period is in effect.

NRND: Not recommended for new designs. Device is in production to support existing customers, but TI does not recommend using this part in a new design.

PREVIEW: Device has been announced but is not in production. Samples may or may not be available.

OBSOLETE: TI has discontinued the production of the device.

(2) **RoHS:** TI defines "RoHS" to mean semiconductor products that are compliant with the current EU RoHS requirements for all 10 RoHS substances, including the requirement that RoHS substance do not exceed 0.1% by weight in homogeneous materials. Where designed to be soldered at high temperatures, "RoHS" products are suitable for use in specified lead-free processes. TI may reference these types of products as "Pb-Free".

RoHS Exempt: TI defines "RoHS Exempt" to mean products that contain lead but are compliant with EU RoHS pursuant to a specific EU RoHS exemption.

Green: TI defines "Green" to mean the content of Chlorine (Cl) and Bromine (Br) based flame retardants meet JS709B low halogen requirements of <=1000ppm threshold. Antimony trioxide based flame retardants must also meet the <=1000ppm threshold requirement.

(3) MSL, Peak Temp. - The Moisture Sensitivity Level rating according to the JEDEC industry standard classifications, and peak solder temperature.

(4) There may be additional marking, which relates to the logo, the lot trace code information, or the environmental category on the device.

(5) Multiple Device Markings will be inside parentheses. Only one Device Marking contained in parentheses and separated by a "-" will appear on a device. If a line is indented then it is a continuation of the previous line and the two combined represent the entire Device Marking for that device.

(6) Lead/Ball Finish - Orderable Devices may have multiple material finish options. Finish options are separated by a vertical ruled line. Lead/Ball Finish values may wrap to two lines if the finish value exceeds the maximum column width.

Important Information and Disclaimer: The information provided on this page represents TI's knowledge and belief as of the date that it is provided. TI bases its knowledge and belief on information provided by third parties, and makes no representation or warranty as to the accuracy of such information. Efforts are underway to better integrate information from third parties. TI has taken and

continues to take reasonable steps to provide representative and accurate information but may not have conducted destructive testing or chemical analysis on incoming materials and chemicals. TI and TI suppliers consider certain information to be proprietary, and thus CAS numbers and other limited information may not be available for release.

In no event shall TI's liability arising out of such information exceed the total purchase price of the TI part(s) at issue in this document sold by TI to Customer on an annual basis.

IMPORTANT NOTICE AND DISCLAIMER

TI PROVIDES TECHNICAL AND RELIABILITY DATA (INCLUDING DATASHEETS), DESIGN RESOURCES (INCLUDING REFERENCE DESIGNS), APPLICATION OR OTHER DESIGN ADVICE, WEB TOOLS, SAFETY INFORMATION, AND OTHER RESOURCES "AS IS" AND WITH ALL FAULTS, AND DISCLAIMS ALL WARRANTIES, EXPRESS AND IMPLIED, INCLUDING WITHOUT LIMITATION ANY IMPLIED WARRANTIES OF MERCHANTABILITY, FITNESS FOR A PARTICULAR PURPOSE OR NON-INFRINGEMENT OF THIRD PARTY INTELLECTUAL PROPERTY RIGHTS.

These resources are intended for skilled developers designing with TI products. You are solely responsible for (1) selecting the appropriate TI products for your application, (2) designing, validating and testing your application, and (3) ensuring your application meets applicable standards, and any other safety, security, or other requirements. These resources are subject to change without notice. TI grants you permission to use these resources only for development of an application that uses the TI products described in the resource. Other reproduction and display of these resources is prohibited. No license is granted to any other TI intellectual property right or to any third party intellectual property right. TI disclaims responsibility for, and you will fully indemnify TI and its representatives against, any claims, damages, costs, losses, and liabilities arising out of your use of these resources.

TI's products are provided subject to TI's Terms of Sale (www.ti.com/legal/termsofsale.html) or other applicable terms available either on ti.com or provided in conjunction with such TI products. TI's provision of these resources does not expand or otherwise alter TI's applicable warranties or warranty disclaimers for TI products.

Mailing Address: Texas Instruments, Post Office Box 655303, Dallas, Texas 75265
Copyright © 2020, Texas Instruments Incorporated