

PIN ASSIGNMENT:

PIN NO	A1&B12	A4&B9	A5	A5	A9&B4	A12&B1
SIGNAL NAME	GND	VBUS	CC1	CC2	VBUS	GND
PCB PAD NO.	C1	C2	C3	C4	C5	C6

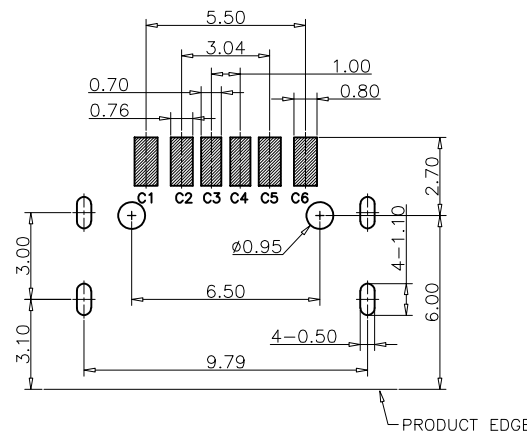

RECOMMEND P.C.B LAYOUT (COMPONENT SIDE)
TOLERANCE FOR PCB LAYOUT IS ± 0.05

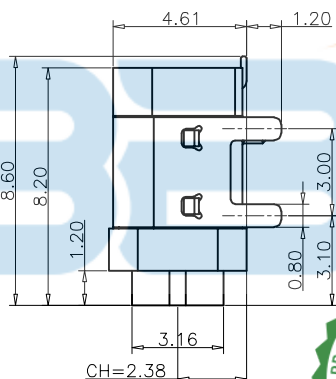

NOTES:

SPECIFICATION:

- CURRENT RATING: 3.0A MAX
- VOLTAGE: 100 VAC
- TEMPERATURE RANGE: $-30^{\circ}\text{C} \sim +85^{\circ}\text{C}$
- CONTACT RESISTANCE: 40 MILLIONHM MAX
- INSULATION RESISTANCE: 100 MEGOHMS MIN
- INSERTION FORCE: 5N~20N
- UNMATING FORCE: 8N-20N
- DURABILITY: 10000 CYCLES
- WATER PROOFNESS: THIS PRODUCT IS BASED ON IPX7.

REV. (版本号)	DESCRIPTION (变更说明)	DATE (日期)	APPD (核准)
A0	新订图面		

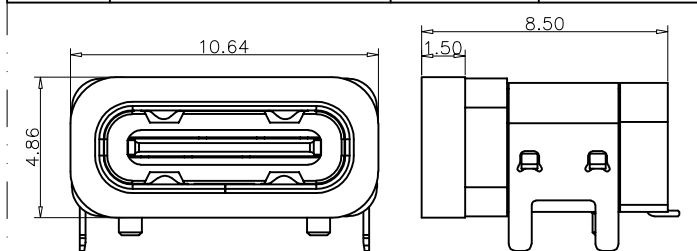

加防水圈示意图

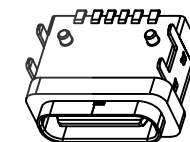
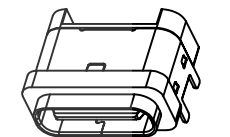
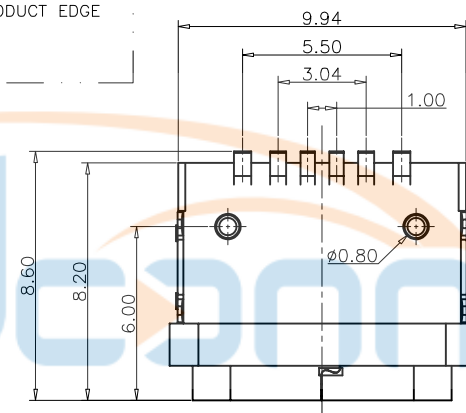

TABLE:

NO	PART	Q'TY	Material
1	SHELL	1	STAINLESS STEEL, NI PLATED
2	CONTACT	6	COPPER STEEL, TIN/AU/NI PLATED
3	MID PLATE	1	STAINLESS STEEL, NO PLATING
4	1MD HOUSING	1	HIGH TEMPERATURE RESISTANT PLASTIC BLACK UL94 V-0
5	2MD HOUSING	1	HIGH TEMPERATURE RESISTANT PLASTIC BLACK UL94 V-0
6	SHIELDING PLATE	1	STAINLESS STEEL, NI PLATED

深圳市步步精科技有限公司		页码 (SHEET)		单位 (UNIT): MM
		版本 (REV)	A0	比例 (SCALE) 1:1
品名 (TITLE)	TYPE-C 6P 母座板上四脚插防水I=8.20带柱 IPX7 CH=2.38	日期 (DATE)		
		设计 (DESIGN)	HMY	未注公差 TOLERANCE UNSPECIFIED
料号 (PART NO)	UC.01.53-1J-0006	审核 (CHECKED)	LYX	X.X ±0.30
		核准 (APPROVED)	LJP	X.XX ±0.20
	0395-1			X.XXX ±0.10
				X° ±5°
				X.X° ±2°



REV.	ECN NO.	DESCRIPTION	DRAW	APPD.	DATE
A	---	新版本发行 (INITIAL EDITION)			

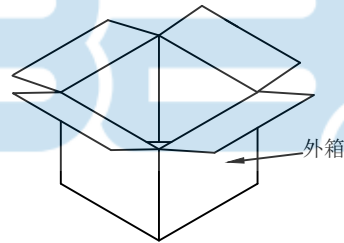
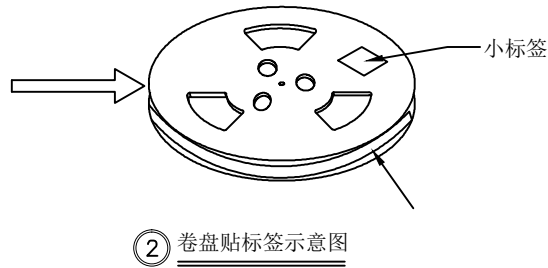
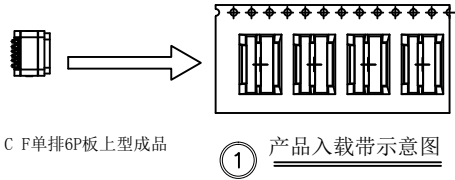

NOTE:

1. QUANTITY/REEL: 700 PCS

數量/卷: 700 PCS

QUANTITY/INNER CARTON: 700 X 10 = 7000 PCS

數量/箱: 700 X 10 = 7000 PCS

2. FREE 20 CAVE IN THE FRONT CARRIER AND FREE 20 CAVE IN THE END CARRIER.

包裝帶內圈空20格, 外圈空20格.

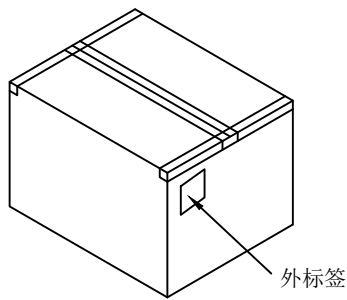

1	成品			
2	CARRIER TAPE	PET	W=24mm T=0.35mm	——
3	COVER TAPE	PET	W=13.3mm T=0.05mm	——
4	小标签		L102mm*W59mm	10
5	卷盘	PS	ø330MM*W28.5MM	10
6	外标签		L102mm*W102mm	1
7	外箱	A=A	L330mm*W330mm*320mm	1
ITEM	DESC.	MATERIAL	REMARKS	QTY

TOLERANCE		NAME (INTENDED USE) 包装规范		深圳市步步精科技有限公司	
X. ±0.20	X.* ± 2°	PART NO.		TITLE:	
.X ±0.15	.X* ± 1°	UC.01.53-1J-0006		TYPE-C 6P 母座板上四脚插孔 L=8.20 带柱 IPX7 CH=2.38	
.XX ±0.10	.XX* ±0.5°	APPD: LJP		0395-1	
UNITS	mm	CHED: LYX		SCALE SHEET REV.	
MATERILA		DRAW: HMY		NONE 1/1 A	
FINISH					