

Schottky Diodes

●Features:

- Common Cathode Structure
- Low Power Loss and High Efficiency
- Low Forward Voltage Drop
- High Surge Capability

●Application:

- High Frequency Switch
- Free Wheeling, and Polarity Protection Applications

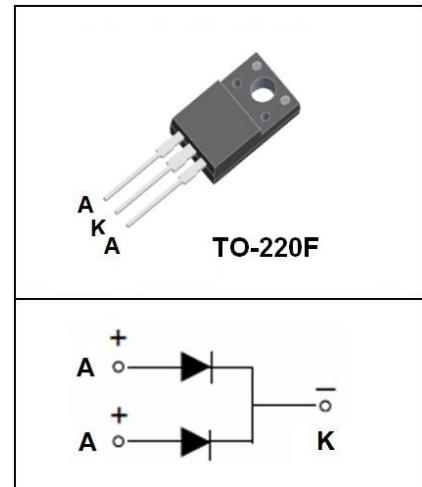

Absolute Maximum Ratings (T_c=25°C unless otherwise noted)

Symbol	Parameter	Value	Unit
V _{RRM}	Maximum Repetitive Reverse Voltage	100	V
V _R	Maximum DC Reverse Voltage	100	V
I _{F(AV)}	Average Rectified Forward Current, T _c =120°C	15(Per Leg) 30(Per Device)	A
I _{FSM}	Peak Forward Surge Current, 8.3ms Half Sine wave	250	A
T _j	Operating Junction Temperature	150	°C
T _{stg}	Storage Temperature Range	-55 to +150	°C

Thermal Characteristics (T_c=25°C unless otherwise noted)

Symbol	Parameter	Max	Unit
R _{θJC}	Thermal Resistance, Junction to Case Per Leg	3.2	°C / W

Electrical Characteristics (T_c=25°C unless otherwise noted)

Symbol	Parameter	Test Conditions	Min	Max	Unit
V _{RRM}	Maximum Repetitive Reverse Voltage	I _R =100μA	100		V
I _R	Reverse Current	V _R = 100V T _c =25°C V _R = 100V T _c =125°C		0.1 5	mA
V _F	Forward Voltage	I _F =15A T _c =25°C I _F =15A T _c =125°C I _F =30A T _c =25°C I _F =30A T _c =125°C		0.88 0.78 1.05 0.95	V

Typical Performance Characteristics

Figure 1. Forward Current Characteristics

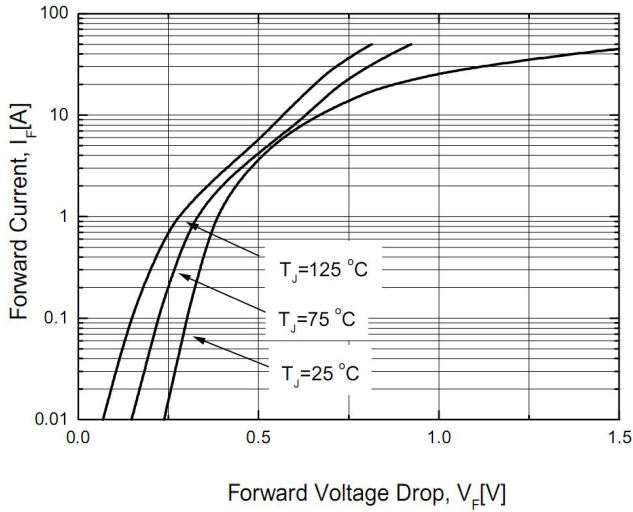

Figure 2. Reverse Leakage Current

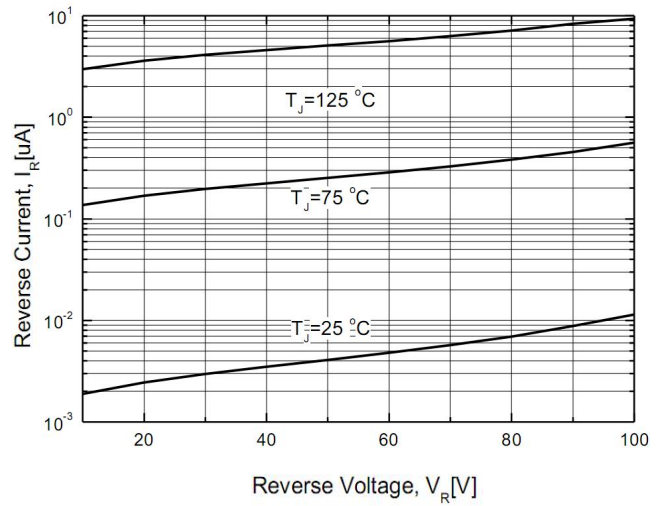

Figure 3. Junction Capacitance

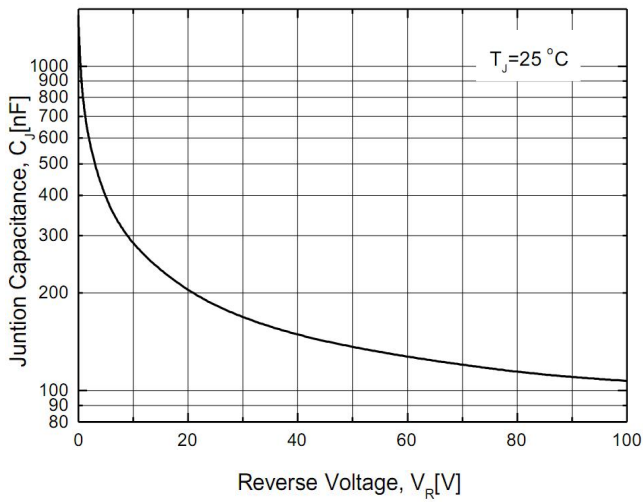
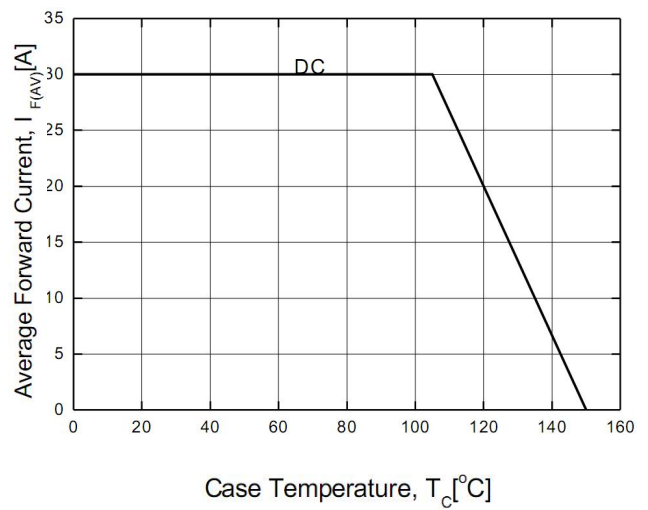

Figure 4. Power Derating



TO-220F Package Dimensions

UNIT: mm

SYMBOL	min	nom	max	SYMBOL	min	nom	max
A	9.80		10.60	D		2.54	
A1		7.00		D1	1.15		1.55
A2	2.90		3.40	D2	0.60		1.00
A3	9.10		9.90	D3	0.20		0.50
B1	15.40		16.40	E	2.24		2.84
B2	4.35		4.95	E1		0.70	
B3	6.00		7.40	E2		1.0×45°	
C	3.00		3.70	E3	0.35		0.65
C1	15.00		17.00	E4	2.30		3.30
C2	8.80		10.80	α (度)		30°	

