

»Features

- 230Watts peak pulse power ($t_p = 8/20\mu s$)
- Tiny 0805 package
- Bidirectional configurations
- Solid-state silicon-avalanche technology
- Low clamping voltage
- Low leakage current
- Low capacitance ($C_j = 1.4pF$ typ.)
- Protection one data/power line
- IEC 61000-4-2 $\pm 30V$ contact $\pm 30kV$ air
- 1.2/50 μs 12ohm 2kV (GbE PHY side)
- 10/700 μs 40ohm 4kV (GbE PHY side)

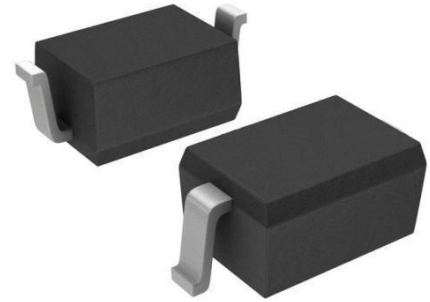

»Applications

- 10/100/1000Ethernet
- Integated Magnetics/RJ45Connectors
- LAN/WAN Equipment
- Notebooks, Desktops, and Servers
- Portable Instrumentation

»Mechanical Data

- SOD323 package
- Molding compound flammability rating: UL 94V-0
- Packaging: Tape and Reel
- RoHS/WEEE Compliant

»Schematic & PINConfiguration

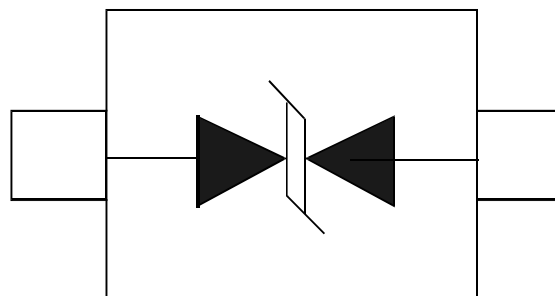

SOD-323

»Absolute Maximum Rating

Rating	Symbol	Value	Units
Peak Pulse Power ($t_p=8/20\mu s$)	P_{PP}	230	Watts
Peak Pulse Current ($t_p=8/20\mu s$)(note1)	I_{pp}	14	A
ESD per IEC 61000-4-2 (Air) ESD per IEC 61000-4-2(Contact)	V_{ESD}	30 30	kV
Lead Soldering Temperature	T_L	260(10seconds)	$^{\circ}C$
Junction Temperature	T_J	-55 to +125	$^{\circ}C$
Storage Temperature	T_{stg}	-55 to +125	$^{\circ}C$

»Electrical Characteristics

Parameter	Symbol	Conditions	Min	Typical	Max	Units
Reverse Stand-Off Voltage	V_{RWM}				5.0	V
Reverse Breakdown Voltage	V_{BR}	$I_T=1mA$	6.0			V
Reverse Leakage Current	I_R	$V_{RWM}=5.0V, T=25^{\circ}C$			1	μA
Clamping Voltage	V_C	$I_{PP}=7A, t_p=8/20V$			13	V
Clamping Voltage	V_C	$I_{PP}=14A, t_p=8/20\mu s$			17	V
Junction Capacitance	C_j	$V_R = 0V, f = 1MHz$		1.4		pF

»Electrical Parameters (TA = 25°C unless otherwise noted)

Symbol	Parameter
I_{PP}	Maximum Reverse Peak Pulse Current
V_C	Clamping Voltage @ I_{PP}
V_{RWM}	Working Peak Reverse Voltage
I_R	Maximum Reverse Leakage Current @ V_{RWM}
V_T	Trigger Voltage @ I_T
I_T	Test Current

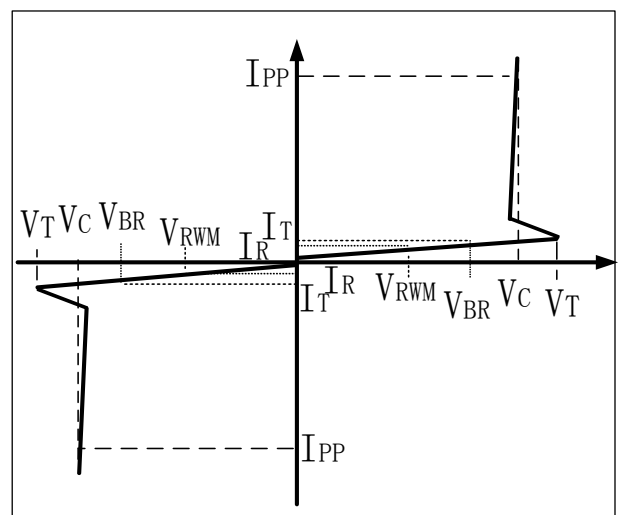

Note: 8/20 μs pulse waveform.

»Typical Characteristics

Figure 1: Peak Pulse Power vs. Pulse Time

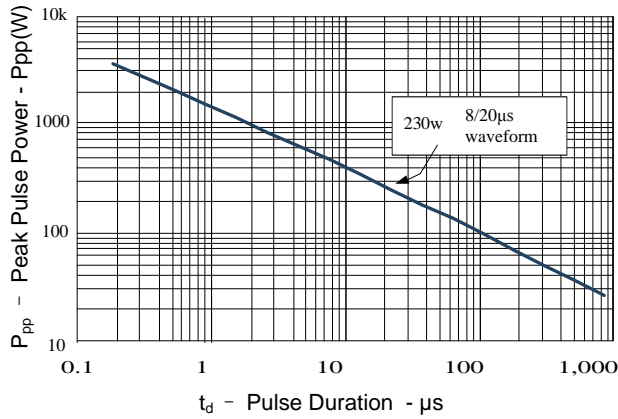

Figure 2: Power Derating Curve

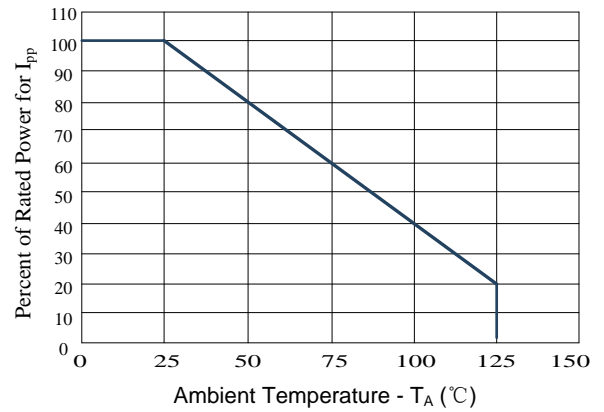

Figure3: Pulse Waveform

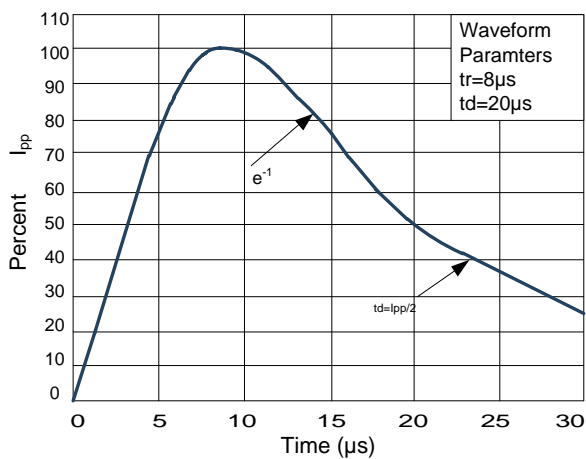
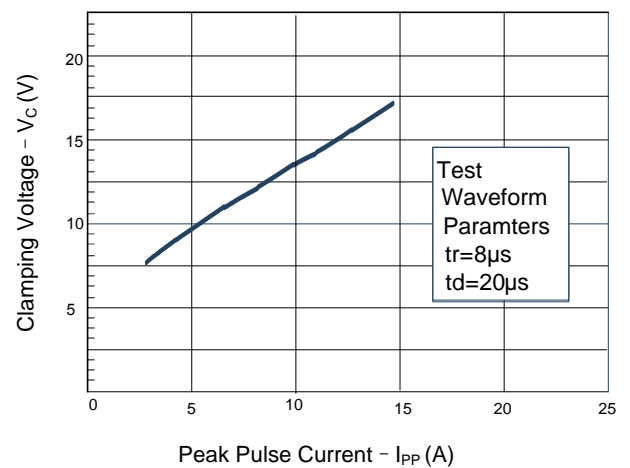

Figure 4: Clamping Voltage vs. I_pp



»Lightning Surge Test Results for Gigabit Ethernet

During the metallic (line-to-line) surge test, the line being stressed is tied to the surge generator with the remaining lines tied together and connected to the generator ground. Current will flow through the line transformer transferring energy to the PHY side of the transformer. Figure 5 shows the test set-up for measuring the clamping voltage of the device. This set up is designed to test the surge in an actual gigabit Ethernet (GbE) circuit. Two 4.7 Ohm resistors is used for decoupling. The clamping voltage of the **PESD5V0U1BA-N** for a metallic mode 4KV (10/ 700µs) surge. The clamping voltage, measured at less than 13 volts, provides sufficient clamping margin to minimize electrical stress and is well below the failure voltage range of typical GbE PHY chips .

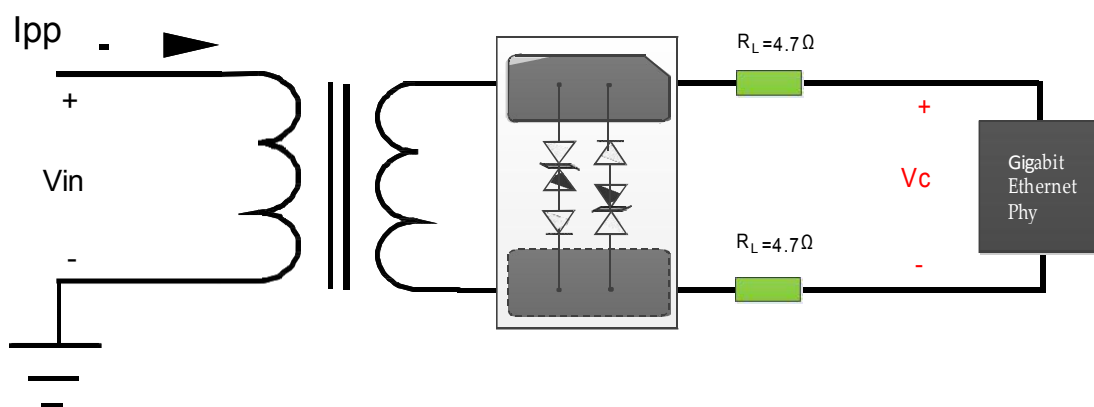

Figure5-Clamping Voltage Test Set-Up

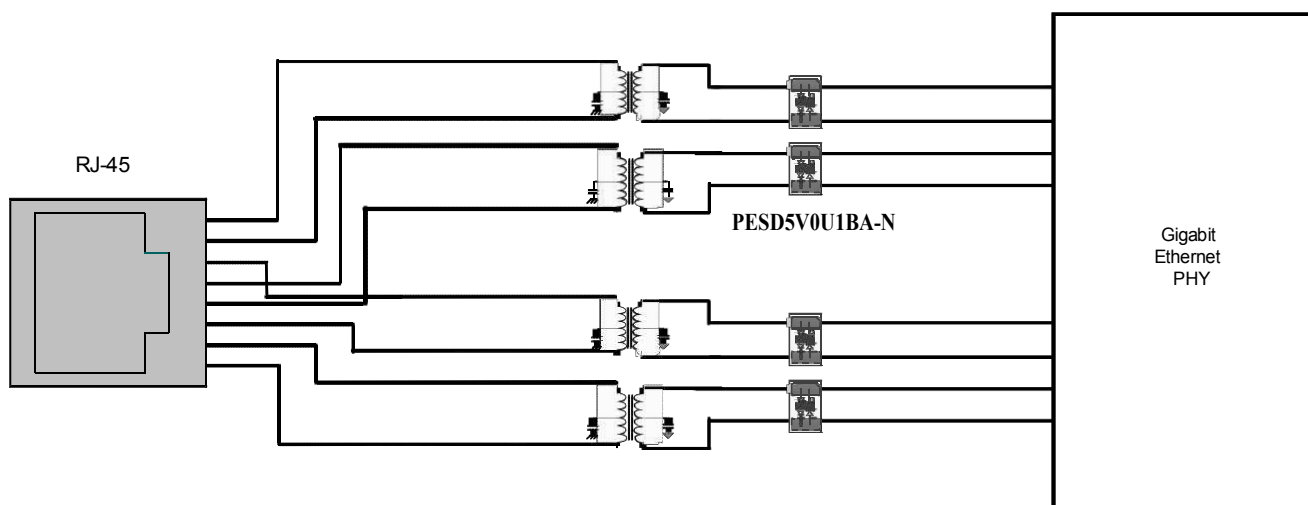
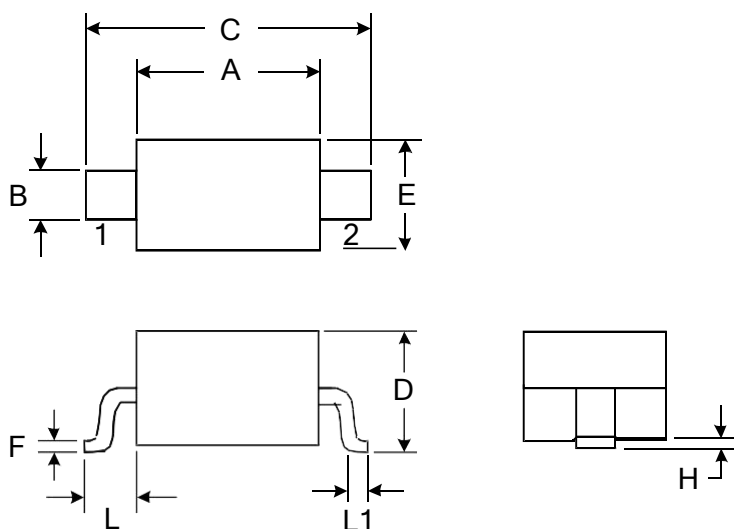

Figure 6 - GbE Protection to Lightning, ESD, and CDE

»Outline Drawing – SOD323



DIMENSIONS				
SYMBOL	MILLIMETER		INCHES	
	MIN	MAX	MIN	MAX
A	1.600	1.800	0.063	0.071
B	0.250	0.350	0.010	0.014
C	2.500	2.700	0.098	0.106
D		1.000		0.039
E	1.200	1.400	0.047	0.055
F	0.080	0.150	0.003	0.006
L	0.475 REF		0.019REF	
L1	0.250	0.400	0.010	0.016
H	0.000	0.100	0.000	0.004

Marking



Ordering information

Ordercode	Package	Base qty	Deliverymode
PESD5V0U1BA-N	SOD323	3k	Tape andreel