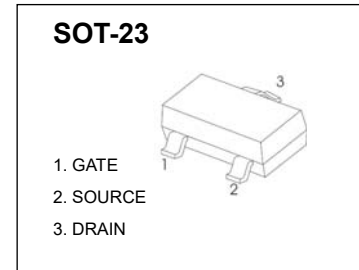

**SOT-23 Plastic-Encapsulate MOSFETS****CJ2324 N-Channel MOSFET**

$V_{(BR)DSS}$	$R_{DS(on)MAX}$	$I_D$
100V	234mΩ@10V	2A
	267mΩ@6V	
	278mΩ@4.5V	

**FEATURE**

- TrenchFET Power MOSFET
- Low  $R_{DS(ON)}$
- Surface Mount Package

**APPLICATION**

- DC/DC Converters
- Load Switch
- LED Backlighting in LCD TVs

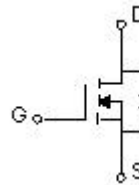
**MARKING****Equivalent Circuit****ABSOLUTE MAXIMUM RATINGS ( $T_a=25^{\circ}\text{C}$  unless otherwise noted)**

Parameter	Symbol	Value	Unit
Drain-Source Voltage	$V_{DS}$	100	V
Gate-Source Voltage	$V_{GS}$	±20	V
Continuous Drain Current	$I_D$	2	A
Pulsed Drain Current	$I_{DM}^*$	8	A
Maximum Power Dissipation	$P_D$	0.35	W
Thermal Resistance from Junction to Ambient	$R_{\theta JA}$	357	$^{\circ}\text{C}/\text{W}$
Operation Junction and Storage Temperature Range	$T_J, T_{STG}$	-55~+150	$^{\circ}\text{C}$
Lead Temperature for Soldering Purposes(1/8" from case for 10 s)	$T_L$	260	$^{\circ}\text{C}$

\*Repetitive rating: Pulse width limited by junction temperature.

## MOSFET ELECTRICAL CHARACTERISTICS

$T_a=25^\circ\text{C}$  unless otherwise specified

Parameter	Symbol	Test Condition	Min	Typ	Max	Unit
<b>STATIC PARAMETERS</b>						
Drain-source breakdown voltage	$V_{(BR)DSS}$	$V_{GS} = 0V, I_D = 250\mu A$	100			V
Zero gate voltage drain current	$I_{DSS}$	$V_{DS} = 100V, V_{GS} = 0V$			1	$\mu A$
Gate-body leakage current	$I_{GSS}$	$V_{GS} = \pm 20V, V_{DS} = 0V$			$\pm 100$	nA
Gate threshold voltage(note 1)	$V_{GS(th)}$	$V_{DS} = V_{GS}, I_D = 250\mu A$	1.2		2.8	V
Drain-source on-resistance (note 1)	$R_{DS(on)}$	$V_{GS} = 10V, I_D = 1.5A$		195	234	m $\Omega$
		$V_{GS} = 6V, I_D = 1A$		200	267	m $\Omega$
		$V_{GS} = 4.5V, I_D = 0.5A$		208	278	m $\Omega$
Forward tranconductance (note 1)	$g_{FS}$	$V_{DS} = 20V, I_D = 1.5A$		2		S
Diode forward voltage (note 1)	$V_{SD}$	$I_S = 1.3A, V_{GS} = 0V$			1.2	V
<b>DYNAMIC PARAMETERS (note2)</b>						
Input Capacitance	$C_{iss}$	$V_{DS} = 50V, V_{GS} = 0V, f = 1MHz$		190		pF
Output Capacitance	$C_{oss}$			22		pF
Reverse Transfer Capacitance	$C_{rss}$			13		pF
Gate Resistance	$R_g$	$F = 1MHz$	0.3		2.8	$\Omega$
<b>SWITCHING PARAMETERS (note 2)</b>						
Turn-on delay time	$t_{d(on)}$	$V_{DD} = 50V, V_{GEN} = 4.5V$ $R_L = 39\Omega, R_G = 1\Omega, I_D = 1.3A$			45	ns
Turn-on rise time	$t_r$				39	ns
Turn-off delay time	$t_{d(off)}$				26	ns
Turn-off fall time	$t_f$				20	ns
Total Gate Charge	$Q_g$	$V_{DS} = 50V, V_{GS} = 4.5V, I_D = 1.6A$			5.8	nC
Gate-Source Charge	$Q_{gs}$			0.75		nC
Gate-Drain Charge	$Q_{gd}$			1.4		nC

- Notes :**
1. Pulse Test : Pulse width  $\leq 300\mu s$ , duty cycle  $\leq 0.5\%$ .
  2. Guaranteed by design, not subject to production testing.

# Typical Characteristics

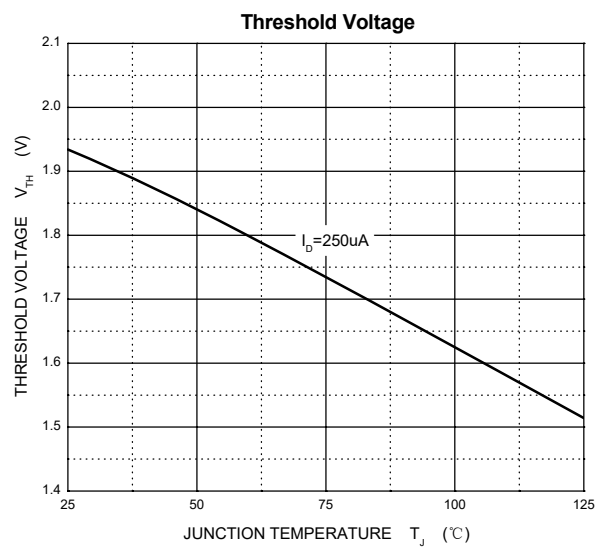
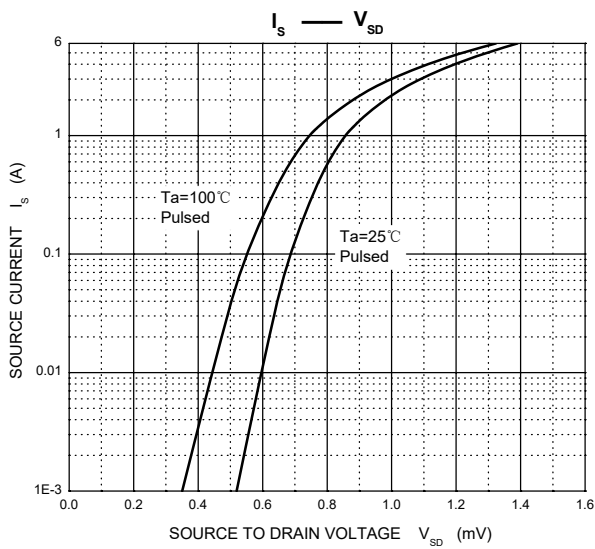
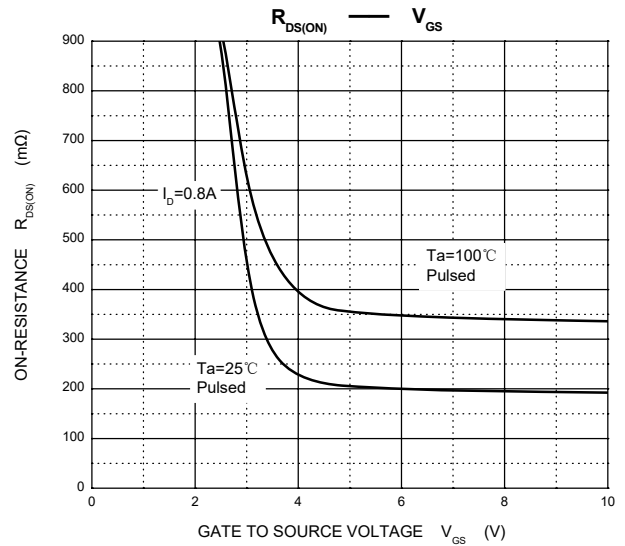
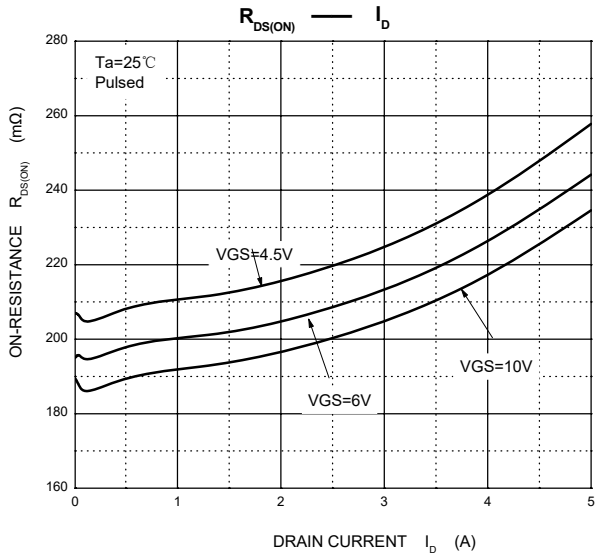
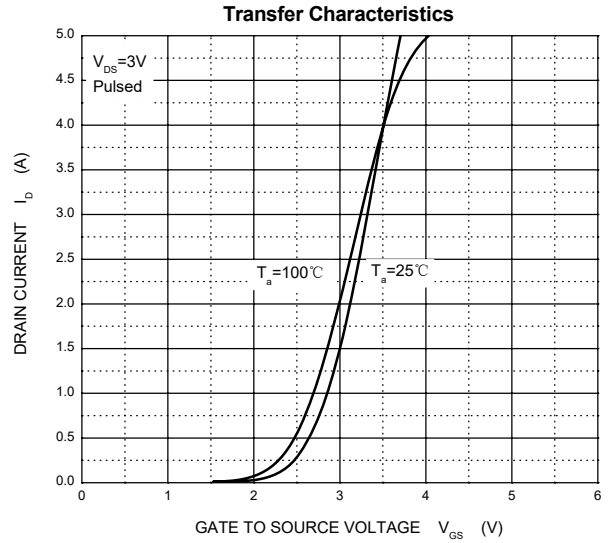
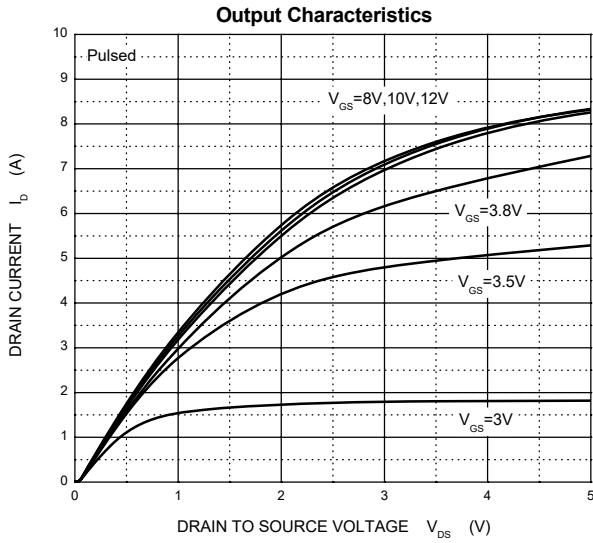

## SOT-23 Package Outline Dimensions



Symbol	Dimensions In Millimeters		Dimensions In Inches	
	Min	Max	Min	Max
A	0.900	1.150	0.035	0.045
A1	0.000	0.100	0.000	0.004
A2	0.900	1.050	0.035	0.041
b	0.300	0.500	0.012	0.020
c	0.080	0.150	0.003	0.006
D	2.800	3.000	0.110	0.118
E	1.200	1.400	0.047	0.055
E1	2.250	2.550	0.089	0.100
e	0.950 TYP		0.037 TYP	
e1	1.800	2.000	0.071	0.079
L	0.550 REF		0.022 REF	
L1	0.300	0.500	0.012	0.020
θ	0°	8°	0°	8°

## SOT-23 Suggested Pad Layout



**Note:**

1. Controlling dimension: in millimeters.
2. General tolerance:  $\pm 0.05\text{mm}$ .
3. The pad layout is for reference purposes only.

**NOTICE**

JSCJ reserves the right to make modifications, enhancements, improvements, corrections or other changes without further notice to any product herein. JSCJ does not assume any liability arising out of the application or use of any product described herein.

## SOT-23 Tape and reel

### SOT-23 Embossed Carrier Tape

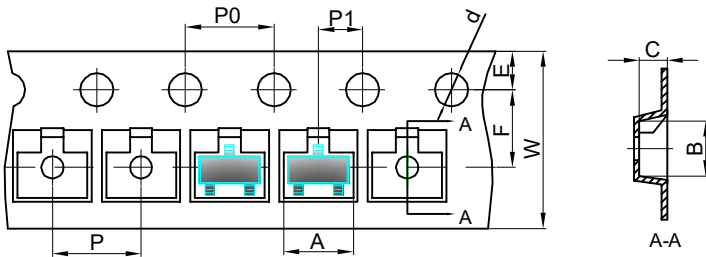

**Packaging Description:**

SOT-23 parts are shipped in tape. The carrier tape is made from a dissipative (carbon filled) polycarbonate resin. The cover tape is a multilayer film (Heat Activated Adhesive in nature) primarily composed of polyester film, adhesive layer, sealant, and anti-static sprayed agent. These reeled parts in standard option are shipped with 3,000 units per 7" or 17.8cm diameter reel. The reels are clear in color and is made of polystyrene plastic (anti-static coated).

Dimensions are in millimeter										
Pkg type	A	B	C	d	E	F	P0	P	P1	W
SOT-23	3.15	2.77	1.22	Ø1.50	1.75	3.50	4.00	4.00	2.00	8.00

### SOT-23 Tape Leader and Trailer

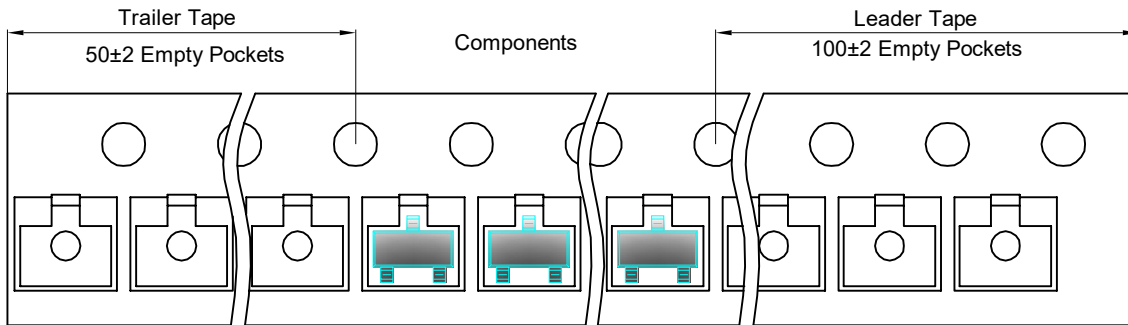

### SOT-23 Reel

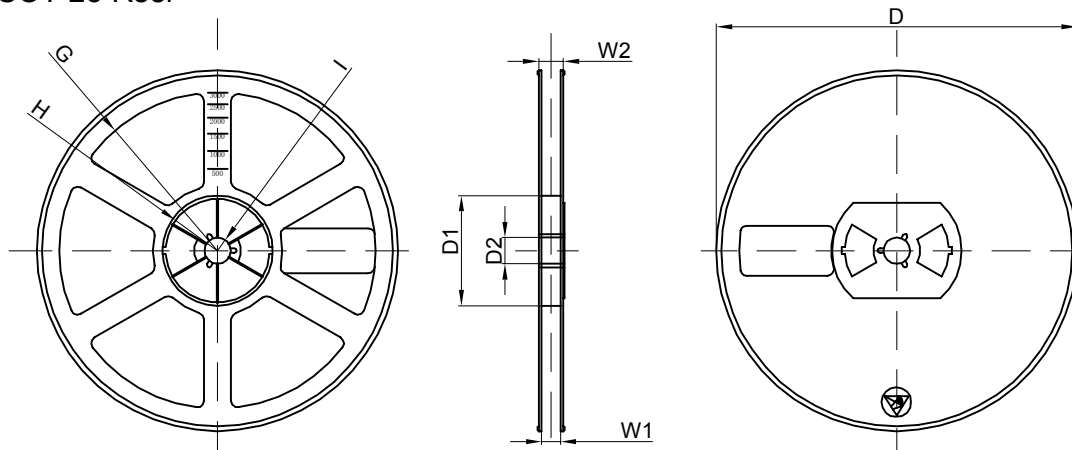

Dimensions are in millimeter								
Reel Option	D	D1	D2	G	H	I	W1	W2
7" Dia	Ø178.00	54.40	13.00	R78.00	R25.60	R6.50	9.50	12.30

REEL	Reel Size	Box	Box Size(mm)	Carton	Carton Size(mm)	G.W.(kg)
3000 pcs	7 inch	30,000 pcs	203×203×195	120,000 pcs	438×438×220	