

## Notice for TAIYO YUDEN products

Please read this notice before using the TAIYO YUDEN products.

### ⚠️ REMINDERS

#### ■ Product Information in this Catalog

Product information in this catalog is as of January 2021. All of the contents specified herein and production status of the products listed in this catalog are subject to change without notice due to technical improvement of our products, etc. Therefore, please check for the latest information carefully before practical application or use of our products.

Please note that TAIYO YUDEN shall not be in any way responsible for any damages and defects in products or equipment incorporating our products, which are caused under the conditions other than those specified in this catalog or individual product specification sheets.

#### ■ Approval of Product Specifications

Please contact TAIYO YUDEN for further details of product specifications as the individual product specification sheets are available. When using our products, please be sure to approve our product specifications or make a written agreement on the product specification with TAIYO YUDEN in advance.

#### ■ Pre-Evaluation in the Actual Equipment and Conditions

Please conduct validation and verification of our products in actual conditions of mounting and operating environment before using our products.

#### ■ Limited Application

##### 1. Equipment Intended for Use

The products listed in this catalog are intended for general-purpose and standard use in general electronic equipment (e.g., AV equipment, OA equipment, home electric appliances, office equipment, information and communication equipment including, without limitation, mobile phone, and PC) and other equipment specified in this catalog or the individual product specification sheets.

TAIYO YUDEN has the line-up of the products intended for use in automotive electronic equipment, telecommunications infrastructure and industrial equipment, or medical devices classified as GHTF Classes A to C (Japan Classes I to III). Therefore, when using our products for these equipment, please check available applications specified in this catalog or the individual product specification sheets and use the corresponding products.

##### 2. Equipment Requiring Inquiry

Please be sure to contact TAIYO YUDEN for further information before using the products listed in this catalog for the following equipment (excluding intended equipment as specified in this catalog or the individual product specification sheets) which may cause loss of human life, bodily injury, serious property damage and/or serious public impact due to a failure or defect of the products and/or malfunction attributed thereto.

- (1) Transportation equipment (automotive powertrain control system, train control system, and ship control system, etc.)
- (2) Traffic signal equipment
- (3) Disaster prevention equipment, crime prevention equipment
- (4) Medical devices classified as GHTF Class C (Japan Class III)
- (5) Highly public information network equipment, data-processing equipment (telephone exchange, and base station, etc.)
- (6) Any other equipment requiring high levels of quality and/or reliability equal to the equipment listed above

##### 3. Equipment Prohibited for Use

Please do not incorporate our products into the following equipment requiring extremely high levels of safety and/or reliability.

- (1) Aerospace equipment (artificial satellite, rocket, etc.)
- (2) Aviation equipment \*<sup>1</sup>
- (3) Medical devices classified as GHTF Class D (Japan Class IV), implantable medical devices \*<sup>2</sup>

- (4) Power generation control equipment (nuclear power, hydroelectric power, thermal power plant control system, etc.)
- (5) Undersea equipment (submarine repeating equipment, underwater work equipment, etc.)
- (6) Military equipment
- (7) Any other equipment requiring extremely high levels of safety and/or reliability equal to the equipment listed above

\*Notes:

1. There is a possibility that our products can be used only for aviation equipment that does not directly affect the safe operation of aircraft (e.g., in-flight entertainment, cabin light, electric seat, cooking equipment) if such use meets requirements specified separately by TAIYO YUDEN. Please be sure to contact TAIYO YUDEN for further information before using our products for such aviation equipment.
2. Implantable medical devices contain not only internal unit which is implanted in a body, but also external unit which is connected to the internal unit.

#### 4. Limitation of Liability

Please note that unless you obtain prior written consent of TAIYO YUDEN, TAIYO YUDEN shall not be in any way responsible for any damages incurred by you or third parties arising from use of the products listed in this catalog for any equipment that is not intended for use by TAIYO YUDEN, or any equipment requiring inquiry to TAIYO YUDEN or prohibited for use by TAIYO YUDEN as described above.

#### ■ Safety Design

When using our products for high safety and/or reliability-required equipment or circuits, please fully perform safety and/or reliability evaluation. In addition, please install (i) systems equipped with a protection circuit and a protection device and/or (ii) systems equipped with a redundant circuit or other system to prevent an unsafe status in the event of a single fault for a failsafe design to ensure safety.

#### ■ Intellectual Property Rights

Information contained in this catalog is intended to convey examples of typical performances and/or applications of our products and is not intended to make any warranty with respect to the intellectual property rights or any other related rights of TAIYO YUDEN or any third parties nor grant any license under such rights.

#### ■ Limited Warranty

Please note that the scope of warranty for our products is limited to the delivered our products themselves and TAIYO YUDEN shall not be in any way responsible for any damages resulting from a failure or defect in our products. Notwithstanding the foregoing, if there is a written agreement (e.g., supply and purchase agreement, quality assurance agreement) signed by TAIYO YUDEN and your company, TAIYO YUDEN will warrant our products in accordance with such agreement.

#### ■ TAIYO YUDEN's Official Sales Channel

The contents of this catalog are applicable to our products which are purchased from our sales offices or authorized distributors (hereinafter "TAIYO YUDEN's official sales channel"). Please note that the contents of this catalog are not applicable to our products purchased from any seller other than TAIYO YUDEN's official sales channel.

#### ■ Caution for Export

Some of our products listed in this catalog may require specific procedures for export according to "U.S. Export Administration Regulations", "Foreign Exchange and Foreign Trade Control Law" of Japan, and other applicable regulations. Should you have any questions on this matter, please contact our sales staff.

▶ This catalog contains the typical specification only due to the limitation of space. When you consider the purchase of our products, please check our product specification sheets. For details of each product (characteristics graph, reliability information, precautions for use, and so on), see our website (<http://www.ty-top.com/>).

# METAL WIRE-WOUND CHIP POWER INDUCTORS (MCOIL™ MB SERIES)

REFLOW

■ PARTS NUMBER

\* Operating Temp.: -40~+105°C (Including self-generated heat)

M	B	K	K	1	6	0	8	T	1	R	0	M	△
①	②	③	④	⑤	⑥	⑦							

△ = Blank space

① Series name

Code	Series name
MB	Metal Wire-Wound chip power inductor

② Dimensions (T)

Code	Dimensions (T) [mm]
KK	1.0
MK	1.2

③ Dimensions (L × W)

Code	Type (inch)	Dimensions (L × W) [mm]
1608	1608 (0603)	1.6 × 0.8
2012	2012 (0805)	2.0 × 1.25
2520	2520 (1008)	2.5 × 2.0

④ Packaging

Code	Packaging
T	Taping

⑤ Nominal inductance

Code (example)	Nominal inductance [μH]
R24	0.24
1R0	1.0
4R7	4.7

※R=Decimal point

⑥ Inductance tolerance

Code	Inductance tolerance
M	±20%
N	±30%

⑦ Internal code

■ STANDARD EXTERNAL DIMENSIONS / STANDARD QUANTITY

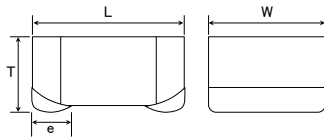

Recommended Land Patterns

Surface Mounting

• Mounting and soldering conditions should be checked beforehand.

• Applicable soldering process to these products is reflow soldering only.

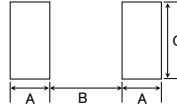

Type	A	B	C
1608	0.55	0.70	1.00
2012	0.60	1.00	1.45
2520	0.60	1.50	2.00

Unit: mm

Type	L	W	T	e	Standard quantity [pcs]	
					Paper tape	Embossed tape
MBKK1608	1.6 ± 0.2 (0.063 ± 0.008)	0.8 ± 0.2 (0.031 ± 0.008)	1.0 max (0.040 max)	0.45 ± 0.15 (0.016 ± 0.006)	—	3000
MBKK2012	2.0 ± 0.2 (0.079 ± 0.008)	1.25 ± 0.2 (0.049 ± 0.008)	1.0 max (0.040 max)	0.5 ± 0.2 (0.020 ± 0.008)	—	3000
MBMK2520	2.5 ± 0.2 (0.098 ± 0.008)	2.0 ± 0.2 (0.079 ± 0.008)	1.2 max (0.047 max)	0.5 ± 0.2 (0.020 ± 0.008)	—	3000

Unit: mm (inch)

► This catalog contains the typical specification only due to the limitation of space. When you consider the purchase of our products, please check our product specification sheets. For details of each product (characteristics graph, reliability information, precautions for use, and so on), see our website (<http://www.ty-top.com/>).

## PARTS NUMBER

### ● MBKK1608(0603) type 【Thickness: 1.0mm max.】

Parts number	EHS	Nominal inductance [ $\mu$ H]	Inductance tolerance	Self-resonant frequency [MHz] (min.)	DC Resistance [ $\Omega$ ] (max.)	Rated current ※) [mA] (max.)		Measuring frequency [MHz]
						Saturation current Idc1	Temperature rise current Idc2	
MBKK1608TR24N	RoHS	0.24	±30%	-	0.049	1,650	2,300	1.0
MBKK1608TR47N	RoHS	0.47	±30%	-	0.104	1,100	1,400	1.0
MBKK1608TR68N	RoHS	0.68	±30%	-	0.120	950	1,200	1.0
MBKK1608T1R0M	RoHS	1.0	±20%	-	0.150	800	1,150	1.0
MBKK1608T1R5M	RoHS	1.5	±20%	-	0.200	650	1,000	1.0
MBKK1608T2R2M	RoHS	2.2	±20%	-	0.345	520	750	1.0
MBKK1608T3R3M	RoHS	3.3	±20%	-	0.512	450	600	1.0
MBKK1608T4R7M	RoHS	4.7	±20%	-	0.730	370	500	1.0

### ● MBKK2012(0805) type 【Thickness: 1.0mm max.】

Parts number	EHS	Nominal inductance [ $\mu$ H]	Inductance tolerance	Self-resonant frequency [MHz] (min.)	DC Resistance [ $\Omega$ ] (max.)	Rated current ※) [mA] (max.)		Measuring frequency [MHz]
						Saturation current Idc1	Temperature rise current Idc2	
MBKK2012TR24N	RoHS	0.24	±30%	-	0.041	3,000	2,400	1.0
MBKK2012TR47N	RoHS	0.47	±30%	-	0.078	2,000	1,650	1.0
MBKK2012TR68N	RoHS	0.68	±30%	-	0.090	1,800	1,500	1.0
MBKK2012T1R0M	RoHS	1.0	±20%	-	0.106	1,500	1,450	1.0
MBKK2012T1R5M	RoHS	1.5	±20%	-	0.173	1,200	1,100	1.0
MBKK2012T2R2M	RoHS	2.2	±20%	-	0.290	900	850	1.0
MBKK2012T3R3M	RoHS	3.3	±20%	-	0.500	700	650	1.0
MBKK2012T4R7M	RoHS	4.7	±20%	-	0.615	600	600	1.0

### ● MBMK2520(1008) type 【Thickness: 1.2mm max.】

Parts number	EHS	Nominal inductance [ $\mu$ H]	Inductance tolerance	Self-resonant frequency [MHz] (min.)	DC Resistance [ $\Omega$ ] (max.)	Rated current ※) [mA] (max.)		Measuring frequency [MHz]
						Saturation current Idc1	Temperature rise current Idc2	
MBMK2520TR24N	RoHS	0.24	±30%	-	0.026	4,750	3,500	1.0
MBMK2520TR47N	RoHS	0.47	±30%	-	0.042	3,900	2,600	1.0
MBMK2520TR68N	RoHS	0.68	±30%	-	0.058	3,150	2,150	1.0
MBMK2520T1R0M	RoHS	1.0	±20%	-	0.072	2,350	1,850	1.0
MBMK2520T1R5M	RoHS	1.5	±20%	-	0.106	2,050	1,500	1.0
MBMK2520T2R2M	RoHS	2.2	±20%	-	0.159	1,800	1,250	1.0
MBMK2520T3R3M	RoHS	3.3	±20%	-	0.260	1,400	970	1.0
MBMK2520T4R7M	RoHS	4.7	±20%	-	0.380	1,150	800	1.0

※) The saturation current value (Idc1) is the DC current value having inductance decrease down to 30%. (at 20°C)

※) The temperature rise current value (Idc2) is the DC current value having temperature increase by 40°C. (at 20°C)

※) The rated current value is following either Idc1 or Idc2, which is the lower one.

# METAL WIRE-WOUND CHIP POWER INDUCTORS (MCOIL™ MB SERIES/MCOIL™ MB-H SERIES)

## PACKAGING

### ① Minimum Quantity

Type	Standard Quantity [pcs]
	Tape & Reel
MBKK1608/MBKK1608H	3000
MBKK2012	3000
MBMK2520/MBMK2520H	3000

### ② Tape Material

#### ● Embossed Tape

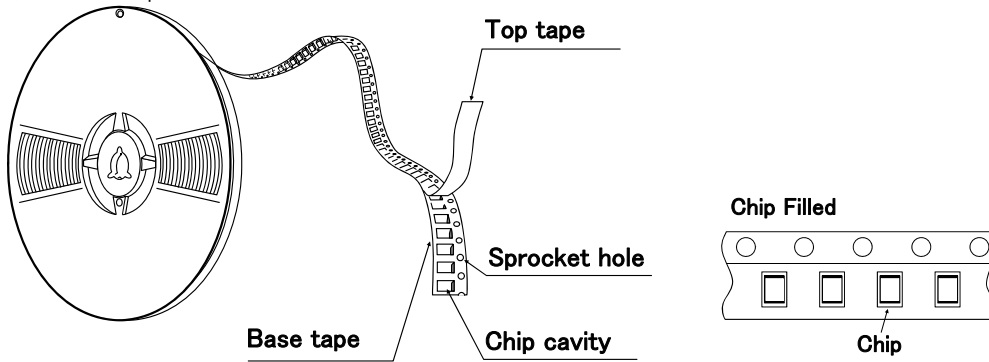

### ③ Taping dimensions

#### ● Embossed tape 8mm wide (0.315 inches wide)

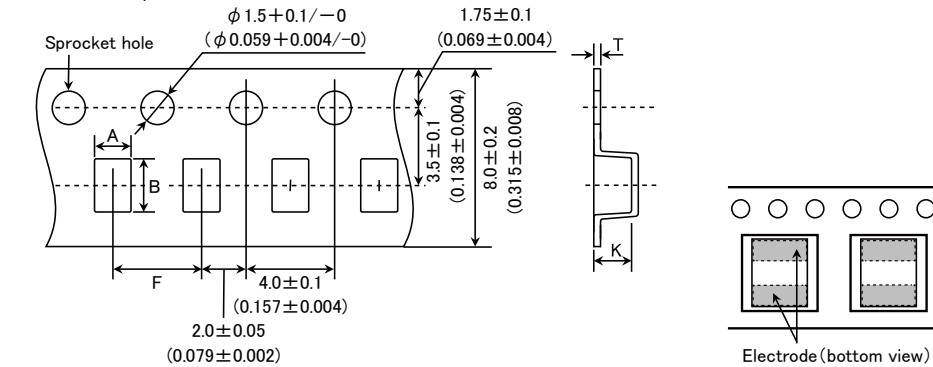

Type	Chip cavity		Insertion pitch	Tape thickness	
	A	B	F	T	K
MBKK1608/MBKK1608H	1.1 (0.043)	1.9 (0.075)	$4.0 \pm 0.1$ ( $0.157 \pm 0.004$ )	$0.25 \pm 0.05$ ( $0.010 \pm 0.002$ )	1.2 max (0.047 max)
MBKK2012	1.45 (0.057)	2.2 (0.087)	$4.0 \pm 0.1$ ( $0.157 \pm 0.004$ )	$0.25 \pm 0.05$ ( $0.010 \pm 0.002$ )	1.2 max (0.047 max)
MBMK2520/MBMK2520H	2.3 (0.091)	2.8 (0.110)	$4.0 \pm 0.1$ ( $0.157 \pm 0.004$ )	$0.3 \pm 0.05$ ( $0.012 \pm 0.002$ )	1.45 max (0.057 max)

Unit : mm (inch)

### ④ Leader and Blank portion

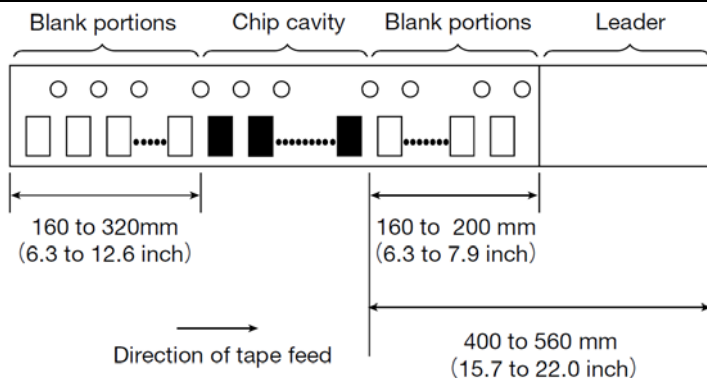

▶ This catalog contains the typical specification only due to the limitation of space. When you consider the purchase of our products, please check our specification. For details of each product (characteristics graph, reliability information, precautions for use, and so on), see our Web site (<http://www.ty-top.com/>).

⑤ Reel size

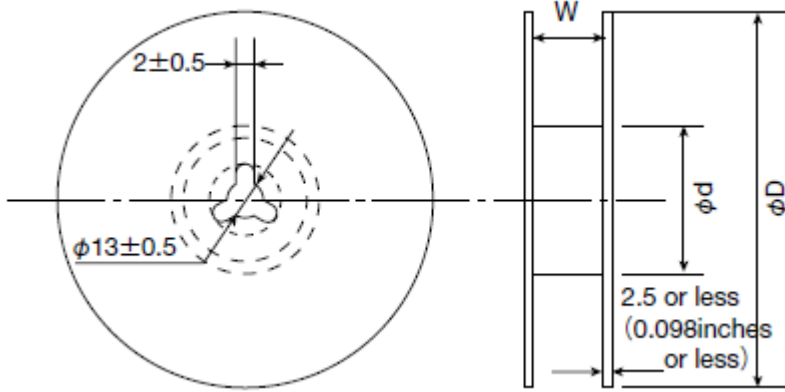

Type	Reel size (Reference values)		
	$\phi D$	$\phi d$	W
MBKK1608 / MBKK1608H	180+0/-3 (7.087+0/-0.118)	60+1/-0 (2.36+0.039/0)	10.0±1.5 (0.394±0.059)
MBKK2012			
MBMK2520 / MBMK2520H			

Unit: mm (inch)

⑥ Top Tape Strength

The top tape requires a peel-off force of 0.2 to 0.7N in the direction of the arrow as illustrated below.



# METAL WIRE-WOUND CHIP POWER INDUCTORS

## (MCOIL™ MB SERIES / MCOIL™ MB-H SERIES)

### RELIABILITY DATA

1. Operating Temperature Range		
Specified Value	MB series	-40~+105°C
	MB-H series	-40~+125°C
Test Methods and Remarks	Including self-generated heat	
2. Storage Temperature Range		
Specified Value	MB series	-40~+85°C
	MB-H series	
Test Methods and Remarks	0 to 40°C for the product with taping.	
3. Rated current		
Specified Value	MB series	Within the specified tolerance
	MB-H series	
4. Inductance		
Specified Value	MB series	Within the specified tolerance
	MB-H series	
Test Methods and Remarks	Measuring equipment : LCR Meter (HP 4285A or equivalent) Measuring frequency : 1MHz, 1V	
5. DC Resistance		
Specified Value	MB series	Within the specified tolerance
	MB-H series	
Test Methods and Remarks	Measuring equipment : DC ohmmeter (HIOKI 3227 or equivalent)	
6. Self resonance frequency		
Specified Value	MB series	-
	MB-H series	
7. Temperature characteristic		
Specified Value	MB series	Inductance change : Within $\pm 15\%$
	MB-H series	
Test Methods and Remarks	MB series : Measurement of inductance shall be taken at temperature range within -40°C~+105°C. With reference to inductance value at +20°C., change rate shall be calculated.	
	MB-H series : Measurement of inductance shall be taken at temperature range within -40°C~+125°C. With reference to inductance value at +20°C., change rate shall be calculated.	

8. Resistance to flexure of substrate		
Specified Value	MB series	No damage
	MB-H series	
Test Methods and Remarks	<p>The test samples shall be soldered to the test board by the reflow. As illustrated below, apply force in the direction of the arrow indicating until deflection of the test board reaches to 2 mm.</p> <p>Test board size : 100 × 40 × 1.0 mm (1608:0.8mm)            Test board material : Glass epoxy-resin            Solder cream thickness : 0.1 mm</p>	

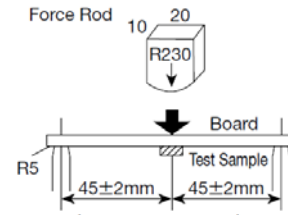

9. Insulation resistance : between wires		
Specified Value	MB series	-
	MB-H series	

10. Insulation resistance : between wire and core		
Specified Value	MB series	DC25V 100kΩ min
	MB-H series	DC50V 100kΩ min

11. Withstanding voltage : between wire and core		
Specified Value	MB series	-
	MB-H series	

12. Adhesion of terminal electrode		
Specified Value	MB series	No abnormality.
	MB-H series	
Test Methods and Remarks	<p>The test samples shall be soldered to the test board by the reflow.</p> <p>Applied force : 10N (1608:5N) to X and Y directions.            Duration : 5s.            Solder cream thickness : 0.1mm.</p>	

13. Resistance to vibration																
Specified Value	MB series	Inductance change : Within ± 10% No significant abnormality in appearance.														
	MB-H series															
Test Methods and Remarks	<p>The test samples shall be soldered to the test board by the reflow. Then it shall be submitted to below test conditions.</p> <table border="1"> <tr> <td>Frequency Range</td> <td colspan="2">10~55Hz</td> </tr> <tr> <td>Total Amplitude</td> <td colspan="2">1.5mm (May not exceed acceleration 196m/s<sup>2</sup>)</td> </tr> <tr> <td>Sweeping Method</td> <td colspan="2">10Hz to 55Hz to 10Hz for 1min.</td> </tr> <tr> <td rowspan="3">Time</td> <td>X</td> <td rowspan="3">For 2 hours on each X, Y, and Z axis.</td> </tr> <tr> <td>Y</td> </tr> <tr> <td>Z</td> </tr> </table> <p>Recovery : At least 2hrs of recovery under the standard condition after the test, followed by the measurement within 48hrs.</p>		Frequency Range	10~55Hz		Total Amplitude	1.5mm (May not exceed acceleration 196m/s <sup>2</sup> )		Sweeping Method	10Hz to 55Hz to 10Hz for 1min.		Time	X	For 2 hours on each X, Y, and Z axis.	Y	Z
Frequency Range	10~55Hz															
Total Amplitude	1.5mm (May not exceed acceleration 196m/s <sup>2</sup> )															
Sweeping Method	10Hz to 55Hz to 10Hz for 1min.															
Time	X	For 2 hours on each X, Y, and Z axis.														
	Y															
	Z															

14. Solderability								
Specified Value	MB series	At least 90% of surface of terminal electrode is covered by new solder.						
	MB-H series							
Test Methods and Remarks	<p>The test samples shall be dipped in flux, and then immersed in molten solder as shown in below table.</p> <p>Flux : Methanol solution containing rosin 25%.</p> <table border="1"> <tr> <td>Solder Temperature</td> <td>245±5°C</td> </tr> <tr> <td>Immersing speed</td> <td>25mm/s</td> </tr> <tr> <td>Time</td> <td>5±0.5 sec.</td> </tr> </table> <p>※Immersion depth : All sides of mounting terminal shall be immersed.</p>		Solder Temperature	245±5°C	Immersing speed	25mm/s	Time	5±0.5 sec.
Solder Temperature	245±5°C							
Immersing speed	25mm/s							
Time	5±0.5 sec.							

▶ This catalog contains the typical specification only due to the limitation of space. When you consider the purchase of our products, please check our specification. For details of each product (characteristics graph, reliability information, precautions for use, and so on), see our Web site (<http://www.ty-top.com/>).

15. Resistance to soldering heat		
Specified Value	MB series	Inductance change : Within $\pm 10\%$ No significant abnormality in appearance.
	MB-H series	
Test Methods and Remarks	The test sample shall be exposed to reflow oven at 230°C for 40 seconds, with peak temperature at 260+0/-5°C for 5 seconds, 3 times. Test board material : Glass epoxy-resin Test board thickness : 1.0mm Recovery : At least 2hrs of recovery under the standard condition after the test, followed by the measurement within 48hrs.	

16. Thermal shock																																						
Specified Value	MB series	Inductance change : Within $\pm 10\%$ No significant abnormality in appearance.																																				
	MB-H series																																					
Test Methods and Remarks	<p>MB series: The test samples shall be soldered to the test board by the reflow. The test samples shall be placed at specified temperature for specified time by step 1 to step 4 as shown in below table in sequence. The temperature cycle shall be repeated 100 cycles.</p> <table border="1"> <thead> <tr> <th colspan="3">Conditions of 1 cycle</th> </tr> <tr> <th>Step</th> <th>Temperature (°C)</th> <th>Duration (min)</th> </tr> </thead> <tbody> <tr> <td>1</td> <td>-40<math>\pm</math>3</td> <td>30<math>\pm</math>3</td> </tr> <tr> <td>2</td> <td>Room temperature</td> <td>Within 3</td> </tr> <tr> <td>3</td> <td>+85<math>\pm</math>2</td> <td>30<math>\pm</math>3</td> </tr> <tr> <td>4</td> <td>Room temperature</td> <td>Within 3</td> </tr> </tbody> </table> <p>Recovery : At least 2hrs of recovery under the standard condition after the test, followed by the measurement within 48hrs.</p>	Conditions of 1 cycle			Step	Temperature (°C)	Duration (min)	1	-40 $\pm$ 3	30 $\pm$ 3	2	Room temperature	Within 3	3	+85 $\pm$ 2	30 $\pm$ 3	4	Room temperature	Within 3	<p>MB-H series: The test samples shall be soldered to the test board by the reflow. The test samples shall be placed at specified temperature for specified time by step 1 to step 4 as shown in below table in sequence. The temperature cycle shall be repeated 100 cycles.</p> <table border="1"> <thead> <tr> <th colspan="3">Conditions of 1 cycle</th> </tr> <tr> <th>Step</th> <th>Temperature (°C)</th> <th>Duration (min)</th> </tr> </thead> <tbody> <tr> <td>1</td> <td>-40<math>\pm</math>3</td> <td>30<math>\pm</math>3</td> </tr> <tr> <td>2</td> <td>Room temperature</td> <td>Within 3</td> </tr> <tr> <td>3</td> <td>+125<math>\pm</math>2</td> <td>30<math>\pm</math>3</td> </tr> <tr> <td>4</td> <td>Room temperature</td> <td>Within 3</td> </tr> </tbody> </table> <p>Recovery : At least 2hrs of recovery under the standard condition after the test, followed by the measurement within 48hrs.</p>	Conditions of 1 cycle			Step	Temperature (°C)	Duration (min)	1	-40 $\pm$ 3	30 $\pm$ 3	2	Room temperature	Within 3	3	+125 $\pm$ 2	30 $\pm$ 3	4	Room temperature	Within 3
	Conditions of 1 cycle																																					
Step	Temperature (°C)	Duration (min)																																				
1	-40 $\pm$ 3	30 $\pm$ 3																																				
2	Room temperature	Within 3																																				
3	+85 $\pm$ 2	30 $\pm$ 3																																				
4	Room temperature	Within 3																																				
Conditions of 1 cycle																																						
Step	Temperature (°C)	Duration (min)																																				
1	-40 $\pm$ 3	30 $\pm$ 3																																				
2	Room temperature	Within 3																																				
3	+125 $\pm$ 2	30 $\pm$ 3																																				
4	Room temperature	Within 3																																				

17. Damp heat														
Specified Value	MB series	Inductance change : Within $\pm 10\%$ No significant abnormality in appearance.												
	MB-H series													
Test Methods and Remarks	<p>MB series: The test samples shall be soldered to the test board by the reflow. The test samples shall be placed in thermostatic oven set at specified temperature and humidity as shown in below table.</p> <table border="1"> <tbody> <tr> <td>Temperature</td> <td>60<math>\pm</math>2°C</td> </tr> <tr> <td>Humidity</td> <td>90~95%RH</td> </tr> <tr> <td>Time</td> <td>1000+24/-0 hour</td> </tr> </tbody> </table> <p>Recovery : At least 2hrs of recovery under the standard condition after the test, followed by the measurement within 48hrs.</p>	Temperature	60 $\pm$ 2°C	Humidity	90~95%RH	Time	1000+24/-0 hour	<p>MB-H series: The test samples shall be soldered to the test board by the reflow. The test samples shall be placed in thermostatic oven set at specified temperature and humidity as shown in below table.</p> <table border="1"> <tbody> <tr> <td>Temperature</td> <td>85<math>\pm</math>2°C</td> </tr> <tr> <td>Humidity</td> <td>85%RH</td> </tr> <tr> <td>Time</td> <td>1000+24/-0 hour</td> </tr> </tbody> </table> <p>Recovery : At least 2hrs of recovery under the standard condition after the test, followed by the measurement within 48hrs.</p>	Temperature	85 $\pm$ 2°C	Humidity	85%RH	Time	1000+24/-0 hour
	Temperature	60 $\pm$ 2°C												
Humidity	90~95%RH													
Time	1000+24/-0 hour													
Temperature	85 $\pm$ 2°C													
Humidity	85%RH													
Time	1000+24/-0 hour													

18. Loading under damp heat																		
Specified Value	MB series	Inductance change : Within $\pm 10\%$ No significant abnormality in appearance.																
	MB-H series																	
Test Methods and Remarks	<p>MB series: The test samples shall be soldered to the test board by the reflow. The test samples shall be placed in thermostatic oven set at specified temperature and humidity and applied the rated current continuously as shown in below table.</p> <table border="1"> <tbody> <tr> <td>Temperature</td> <td>60<math>\pm</math>2°C</td> </tr> <tr> <td>Humidity</td> <td>90~95%RH</td> </tr> <tr> <td>Applied current</td> <td>Rated current</td> </tr> <tr> <td>Time</td> <td>1000+24/-0 hour</td> </tr> </tbody> </table> <p>Recovery : At least 2hrs of recovery under the standard condition after the test, followed by the measurement within 48hrs.</p>	Temperature	60 $\pm$ 2°C	Humidity	90~95%RH	Applied current	Rated current	Time	1000+24/-0 hour	<p>MB-H series: The test samples shall be soldered to the test board by the reflow. The test samples shall be placed in thermostatic oven set at specified temperature and humidity and applied the rated current continuously as shown in below table.</p> <table border="1"> <tbody> <tr> <td>Temperature</td> <td>85<math>\pm</math>2°C</td> </tr> <tr> <td>Humidity</td> <td>85%RH</td> </tr> <tr> <td>Applied current</td> <td>Rated current</td> </tr> <tr> <td>Time</td> <td>1000+24/-0 hour</td> </tr> </tbody> </table> <p>Recovery : At least 2hrs of recovery under the standard condition after the test, followed by the measurement within 48hrs.</p>	Temperature	85 $\pm$ 2°C	Humidity	85%RH	Applied current	Rated current	Time	1000+24/-0 hour
	Temperature	60 $\pm$ 2°C																
Humidity	90~95%RH																	
Applied current	Rated current																	
Time	1000+24/-0 hour																	
Temperature	85 $\pm$ 2°C																	
Humidity	85%RH																	
Applied current	Rated current																	
Time	1000+24/-0 hour																	

19. Low temperature life test						
Specified Value	MB series	Inductance change : Within $\pm 10\%$ No significant abnormality in appearance.				
	MB-H series					
Test Methods and Remarks	<p>The test samples shall be soldered to the test board by the reflow. After that, the test samples shall be placed at test conditions as shown in below table.</p> <table border="1"> <tbody> <tr> <td>Temperature</td> <td>-40<math>\pm</math>2°C</td> </tr> <tr> <td>Time</td> <td>1000+24/-0 hour</td> </tr> </tbody> </table> <p>Recovery : At least 2hrs of recovery under the standard condition after the test, followed by the measurement within 48hrs.</p>		Temperature	-40 $\pm$ 2°C	Time	1000+24/-0 hour
Temperature	-40 $\pm$ 2°C					
Time	1000+24/-0 hour					



20. High temperature life test		
Specified Value	MB series	Inductance change : Within $\pm 10\%$ No significant abnormality in appearance.
	MB-H series	
Test Methods and Remarks	The test samples shall be soldered to the test board by the reflow. After that, the test samples shall be placed at test conditions as shown in below table.	
	Temperature	$85 \pm 2^\circ\text{C}$
	Time	$1000 \pm 24 / -0$ hour
Recovery : At least 2hrs of recovery under the standard condition after the test, followed by the measurement within 48hrs.		

21. Loading at high temperature life test		
Specified Value	MB series	—
	MB-H series	

22. Standard condition		
Specified Value	MB series	Standard test condition : Unless otherwise specified, temperature is $20 \pm 15^\circ\text{C}$ and $65 \pm 20\%$ of relative humidity. When there is any question concerning measurement result: In order to provide correlation data, the test shall be condition of $20 \pm 2^\circ\text{C}$ of temperature, $65 \pm 5\%$ relative humidity. Inductance is in accordance with our measured value.
	MB-H series	

# METAL WIRE-WOUND CHIP POWER INDUCTORS

## (MCOIL™ MB SERIES / MCOIL™ MB-H SERIES)

### PRECAUTIONS

1. Circuit Design	
Precautions	<ul style="list-style-type: none"> <li>◆ Operating environment               <ol style="list-style-type: none"> <li>1. The products described in this specification are intended for use in general electronic equipment, (office supply equipment, telecommunications systems, measuring equipment, and household equipment). They are not intended for use in mission-critical equipment or systems requiring special quality and high reliability (traffic systems, safety equipment, aerospace systems, nuclear control systems and medical equipment including life-support systems,) where product failure might result in loss of life, injury or damage. For such uses, contact TAIYO YUDEN Sales Department in advance.</li> </ol> </li> </ul>
2. PCB Design	
Precautions	<ul style="list-style-type: none"> <li>◆ Land pattern design               <ol style="list-style-type: none"> <li>1. Please refer to a recommended land pattern.</li> </ol> </li> </ul>
Technical considerations	<ul style="list-style-type: none"> <li>◆ Land pattern design</li> <li>Surface Mounting               <ul style="list-style-type: none"> <li>• Mounting and soldering conditions should be checked beforehand.</li> <li>• Applicable soldering process to this products is reflow soldering only.</li> </ul> </li> </ul>
3. Considerations for automatic placement	
Precautions	<ul style="list-style-type: none"> <li>◆ Adjustment of mounting machine               <ol style="list-style-type: none"> <li>1. Excessive impact load should not be imposed on the products when mounting onto the PC boards.</li> <li>2. Mounting and soldering conditions should be checked beforehand.</li> </ol> </li> </ul>
Technical considerations	<ul style="list-style-type: none"> <li>◆ Adjustment of mounting machine               <ol style="list-style-type: none"> <li>1. When installing products, care should be taken not to apply distortion stress as it may deform the products.</li> </ol> </li> </ul>
4. Soldering	
Precautions	<ul style="list-style-type: none"> <li>◆ Reflow soldering               <ol style="list-style-type: none"> <li>1. Please contact any of our offices for a reflow soldering, and refer to the recommended condition specified.</li> <li>2. The product shall be used reflow soldering only.</li> <li>3. Please do not add any stress to a product until it returns in normal temperature after reflow soldering.</li> </ol> </li> <li>◆ Lead free soldering               <ol style="list-style-type: none"> <li>1. When using products with lead free soldering, we request to use them after confirming adhesion, temperature of resistance to soldering heat, soldering etc sufficiently.</li> </ol> </li> </ul>
Technical considerations	<ul style="list-style-type: none"> <li>◆ Reflow soldering               <ol style="list-style-type: none"> <li>1. If products are used beyond the range of the recommended conditions, heat stresses may deform the products, and consequently degrade the reliability of the products.</li> </ol> <p>Recommended reflow condition (Pb free solder)</p> <p>Temperature [°C]</p> <p>Heating Time [sec]</p> <p>150~180</p> <p>90 ± 30sec</p> <p>230°C min</p> <p>40sec max</p> <p>5sec max</p> <p>Peak: 260+0/-5°C</p> </li> </ul>
5. Cleaning	
Precautions	<ul style="list-style-type: none"> <li>◆ Cleaning conditions               <ol style="list-style-type: none"> <li>1. Washing by supersonic waves shall be avoided.</li> </ol> </li> </ul>
Technical considerations	<ul style="list-style-type: none"> <li>◆ Cleaning conditions               <ol style="list-style-type: none"> <li>1. If washed by supersonic waves, the products might be broken.</li> </ol> </li> </ul>

▶ This catalog contains the typical specification only due to the limitation of space. When you consider the purchase of our products, please check our specification. For details of each product (characteristics graph, reliability information, precautions for use, and so on), see our Web site (<http://www.ty-top.com/>).

6. Handling	
Precautions	<ul style="list-style-type: none"> <li>◆ Handling               <ol style="list-style-type: none"> <li>1. Keep the product away from all magnets and magnetic objects.</li> </ol> </li> <li>◆ Breakaway PC boards (splitting along perforations)               <ol style="list-style-type: none"> <li>1. When splitting the PC board after mounting product, care should be taken not to give any stresses of deflection or twisting to the board.</li> <li>2. Board separation should not be done manually, but by using the appropriate devices.</li> </ol> </li> <li>◆ Mechanical considerations               <ol style="list-style-type: none"> <li>1. Please do not give the product any excessive mechanical shocks.</li> <li>2. Please do not add any shock and power to a product in transportation.</li> </ol> </li> <li>◆ Pick-up pressure               <ol style="list-style-type: none"> <li>1. Please do not push to add any pressure to a winding part. Please do not give any shock and push into a ferrite core exposure part.</li> </ol> </li> <li>◆ Packing               <ol style="list-style-type: none"> <li>1. Please avoid accumulation of a packing box as much as possible.</li> </ol> </li> </ul>
Technical considerations	<ul style="list-style-type: none"> <li>◆ Handling               <ol style="list-style-type: none"> <li>1. There is a case that a characteristic varies with magnetic influence.</li> </ol> </li> <li>◆ Breakaway PC boards (splitting along perforations)               <ol style="list-style-type: none"> <li>1. The position of the product on PCBs shall be carefully considered to minimize the stress caused from splitting of the PCBs.</li> </ol> </li> <li>◆ Mechanical considerations               <ol style="list-style-type: none"> <li>1. There is a case to be damaged by a mechanical shock.</li> <li>2. There is a case to be broken by the handling in transportation.</li> </ol> </li> <li>◆ Pick-up pressure               <ol style="list-style-type: none"> <li>1. Damage and a characteristic can vary with an excessive shock or stress.</li> </ol> </li> <li>◆ Packing               <ol style="list-style-type: none"> <li>1. If packing boxes are accumulated, that could cause a deformation on packing tapes or a damage on the products.</li> </ol> </li> </ul>
7. Storage conditions	
Precautions	<ul style="list-style-type: none"> <li>◆ Storage               <ol style="list-style-type: none"> <li>1. To maintain the solderability of terminal electrodes and to keep the packing material in good condition, temperature and humidity in the storage area should be controlled.                   <ul style="list-style-type: none"> <li>▪ Recommended conditions                       <ul style="list-style-type: none"> <li>Ambient temperature : 0~40°C</li> <li>Humidity : Below 70% RH</li> </ul> </li> <li>▪ The ambient temperature must be kept below 30°C. Even under ideal storage conditions, solderability of products electrodes may decrease as time passes.                           <ul style="list-style-type: none"> <li>For this reason, product should be used within 6 months from the time of delivery.</li> <li>In case of storage over 6 months, solderability shall be checked before actual usage.</li> </ul> </li> </ul> </li> </ol> </li> </ul>
Technical considerations	<ul style="list-style-type: none"> <li>◆ Storage               <ol style="list-style-type: none"> <li>1. Under a high temperature and humidity environment, problems such as reduced solderability caused by oxidation of terminal electrodes and deterioration of taping/packaging materials may take place.</li> </ol> </li> </ul>