

STANDARD OF HT SERIES CAPACITORS

1. Scope

This Specification covers "HT Series" V-chip aluminum electrolytic capacitors.

2. Reference Standard

Japanese industrial Standard JIS C-5141 characteristics W and JIS C-5101 except as specified in this specification.

3. Environmental Protection Standard

Comply with the EU directive 2011/65/EC

4. Operating Temperature Range

-40°C ~ +105°C

5. Voltage Range

4 ~ 450V

6. Capacitance Range

0.1 ~ 6800μF

7. Capacitance Tolerance

±20% at 120Hz, 20°C

8. Leakage Current

Leakage current (Ø4~Ø10) \cong 0.01CV or 3μA, whichever is greater (after 2 minutes application of rated voltage)

Leakage current (Ø 12.5~Ø 16) \cong 0.03CV or 4μA, whichever is greater (after 1 minute application of rated voltage)

Leakage current (Ø6.3~Ø16) \cong 0.04CV or 100μA, whichever is greater (after 5 minutes application of rated voltage)

9. Tan δ

Measurement frequency: 120Hz, Temperature: 20°C

Rated Voltage (V)		4	6.3	10	16	25	35	50	63	100	160~250	350~450
Tan δ (max.)	Ø4~Ø10	0.35	0.30	0.24	0.20	0.16	0.14	0.14	0.12	0.12	0.20	0.25
	Ø12.5~Ø16	0.42	0.38	0.34	0.30	0.26	0.22	0.18	0.14	0.12	0.20	0.25

10. Stability at Low Temperature

Measurement frequency: 120Hz

Rated Voltage (V)			4	6.3	10	16	25	35	50~63	100	160~250	350~450	
Impedance Ratio ZT/Z20 (max.)	Ø4~Ø10	Z(-25°C) / Z(20°C)	7	4	3	2	2	2	2	3	2	3	
		Z(-40°C) / Z(20°C)	15	8	6	4	4	3	3	4	3	6	
	Ø12.5~Ø16	Z(-25°C) / Z(20°C)	7	5	4	3	2	2	2	2	2	2	4
		Z(-40°C) / Z(20°C)	17	12	10	8	5	4	3	3	3	6	10

11. Load Life

After 2000 hrs. (1000 hrs. for Ø 4~ Ø 6.3 × 5.4) application of the rated voltage at 105°C, they meet the characteristics listed below.

Capacitance Change	Within ±20% of initial value for capacitors of 10V or more (Within ±30% of initial value for capacitors of 4V or less)
Tan δ	200% or less of initial specified value
Leakage Current	Initial specified value or less

12. Self Life

After leaving capacitors under no load at 105 °C for 1000 hours, they meet the specified value for load life characteristics listed above

13. Resistance to Soldering Heat

After reflow soldering and restored at room temperature, they meet the characteristics listed below.

Capacitance Change	Within $\pm 10\%$ of initial value
Tan δ	Initial specified value or less
Leakage Current	Initial specified value or less

14. Surge Voltage

The surge voltage rating is the maximum DC over-voltage to which the capacitors may be subject of short periods not exceeding approximately 30 seconds at infrequent intervals of not less than 5 minutes. The rated surges of the electrolytic capacitors are as follows:

Rated voltage (V)	6.3	10	16	25	35	50	63	100
Surge voltage (V)	8	13	20	32	44	63	79	125

15. Marking and drawing (Unit: mm)

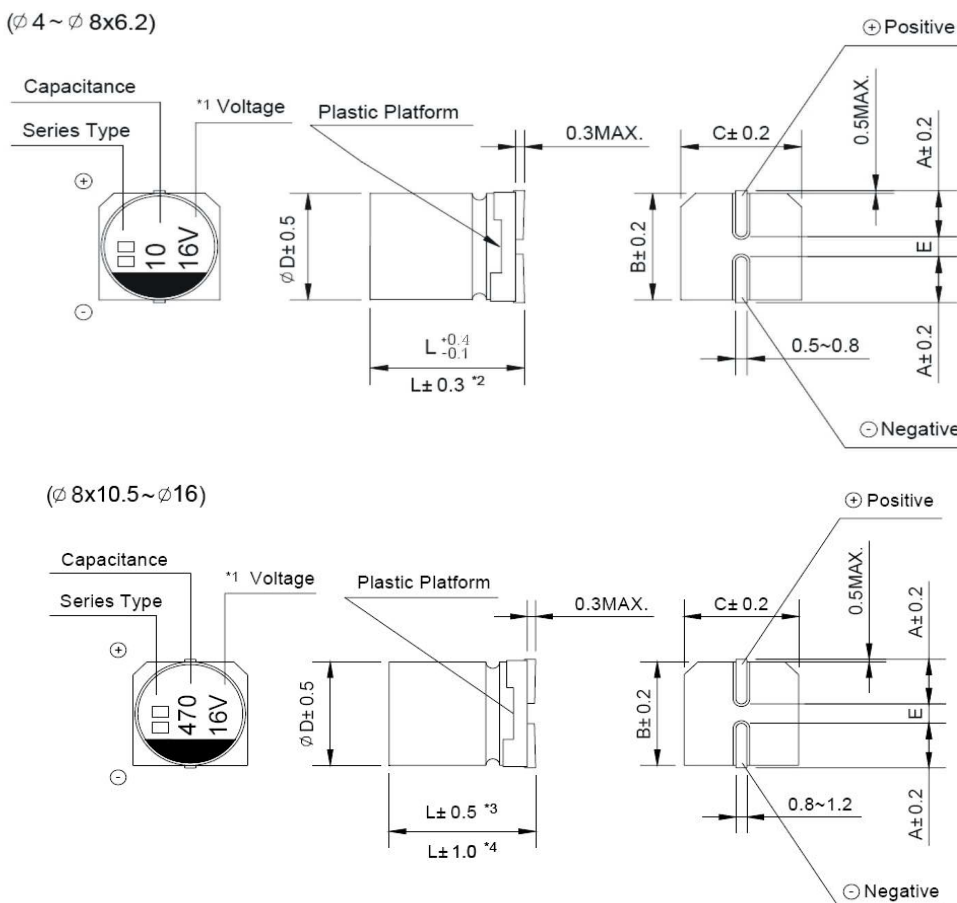

*1. Voltage mark for 6.3V is [6V]

*2. Applicable to $\phi 6.3 \times 7.7$

*3. Applicable to $\phi 8 \times 10.5 \sim \phi 10$

*4. Applicable to $\phi 12.5 \sim \phi 16$

16. Dimensions (Unit: mm)

∅D x L	4 x 5.4	5 x 5.4	6.3 x 5.4	6.3 x 7.7	8 x 6.2	8 x 10.5/12.5	10 x 10.5	10 x 12.5	12.5 x 13.5	12.5 x 16	16 x 16.5
A	1.9	2.2	2.6	2.6	3.3	3.2	3.2	3.2	4.7	4.7	5.5
B	4.3	5.3	6.6	6.6	8.3	8.3	10.3	10.3	13.0	13.0	17.0
C	4.3	5.3	6.6	6.6	8.3	8.3	10.3	10.3	13.0	13.0	17.0
E±0.2	1.0	1.3	2.2	2.2	2.2	3.1	4.4	4.4	4.4	4.4	6.7
φ4~φ8x6.2 L+0.4/L-0.1 φ6.3x7.7 L±0.3 φ8x10.5~φ16 L±0.5	5.4	5.4	5.4	7.7	6.2	10.5	10.5	13.5	13.5	16.0	16.5

17. Taping Specifications

■ Carrier Tape

● Drawing 1 (for ∅4 ~ ∅10)

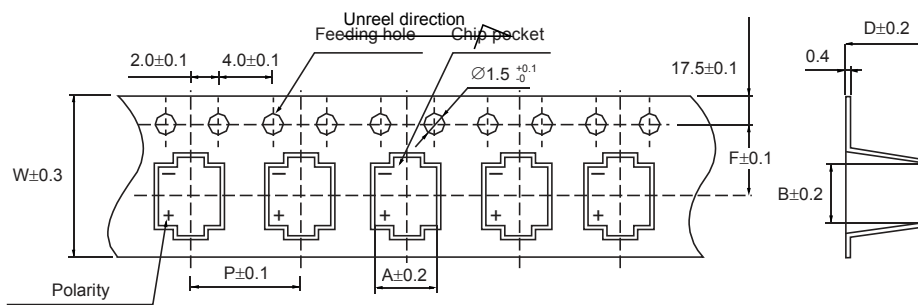

Dimension

(Unit: mm)

∅DxL	4x5.4	5x5.4/5.8	6.3x5.4/5.8	6.3x7.7/10.5	8x6.2	8x10.5/12.5	10x10.5/12.5/13.5
W	12.0	12.0	16.0	16.0	16.0	24.0	24.0
P	8.0	12.0	12.0	12.0	12.0	16.0	16.0
F	5.5	5.5	7.5	7.5	7.5	11.5	11.5
A	5.0	6.0	7.0	7.0	8.7	8.7	10.7
B	5.0	6.0	7.0	7.0	8.7	8.7	10.7
D	6.2	6.2	6.2	8.4/11.0	6.8	11.0/13.2	11.0/14.0

● Drawing 2 (for ∅12.5 ~ ∅16)

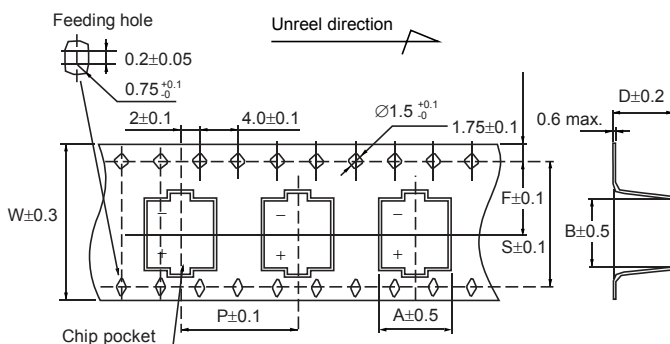

Dimension

(Unit: mm)

∅DxL	12.5x13.5	12.5x16	16x16.5/21.5
W	32.0	32.0	44.0
P	24.0	24.0	28.0
F	14.2	14.2	20.2
A	14.0	14.0	17.5
B	14.0	14.0	17.5
D	14.0	16.5	17.5/22.5
S	28.4	28.4	40.4

■ Reel

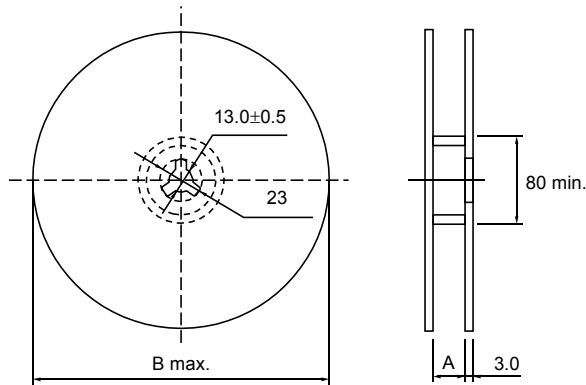

(Unit: mm)

∅D × L	4×5.4/5.8	5×5.4/5.8	6.3×5.4 /7.7/10.5/11.5	8×6.2	8×10.5/12.5	10×10.5/12.5	12.5×13.5/16	16×16.5
A	14	14	18	18	26	26	34	34
B	382	382	382	382	382	382	382/332*	332

*For a small package

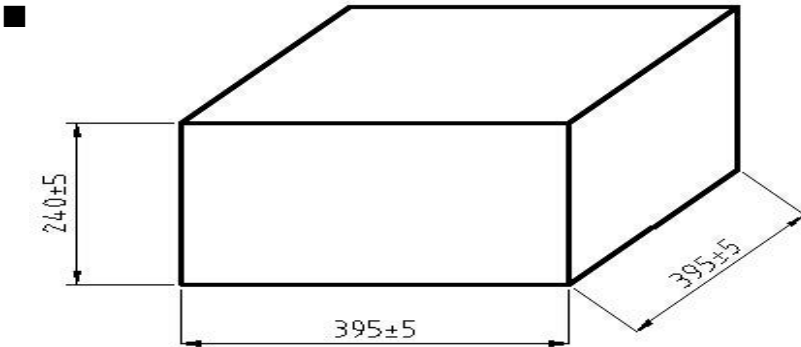

■ Package Quantity

Size ∅D×L (mm)	Reel (pcs)	In-box (reels)	Quantity/In-box (pcs)
4 × 5.4/5.8	2,000	10	20,000
5 × 5.4/5.8	1,000	10	10,000
6.3 × 5.4/5.8	1,000	10	10,000
6.3 × 7.7	1,000	10	10,000
8 × 6.2	1,000	10	10,000
8 × 10.5	500	10	5,000
8 × 12.5	400	10	4,000
10 × 10.5	500	10	5,000
10 × 12.5	400	10	4,000
12.5 × 13.5	200	8	1,600
12.5×16	200	8	1,600
16×16.5	125	2	250

*For a small package

●Please order by minimum package quantity

18. Lead-free Reflow Soldering Condition

A. Recommended Conditions for Reflow Soldering

- (1) A thermal condition system such as infrared radiation (IR) or hot blast should be adopted, and vapor heat transfer systems (VPS) are not recommended.
- (2) Reflow soldering should be within 2 cycles. Please make sure that the parts have enough cooling time.
- (3) For lead-free type reflow soldering, please observe proper conditions below:
 - a) The time of preheating from 150°C to 200°C shall be within maximum 180 seconds;
 - b) The time of soldering temperature at 217°C measured on capacitors' top shall not exceed t_L (second);
 - c) The peak temperature on capacitors' top shall not exceed T_p (°C), and the time within 5°C of actual peak temperature shall not exceed t_p (second).

B. Classification Reflow Profile

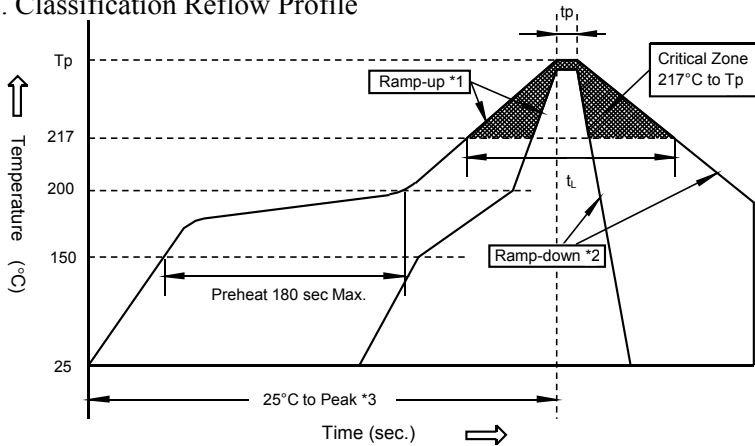

- *1. Average ramp-up rate is 3°C/second max.
- *2. Ramp-down rate is 6°C /second max.
- *3 .Time from 25°C to peak temperature is 8 minutes max.

■ Classified at Temperature and Time Only for Standard Size without ()

Size	Thickness (mm)	Volume (mm ³)	Tp (°C)	t _L (second)	Tp (second)
∅4~∅6.3, ∅8×6.2L	≥2.5	<350	255±0	60	5
∅8×10.5L	≥2.5	350~2000	250±0	60	5
∅10×10.5L/13.5L	≥2.5	350~2000	245±0	60	5
∅12.5, ∅16	≥2.5	>2000	240±0	40	5

19. Recommended Land Size (Unit: mm)

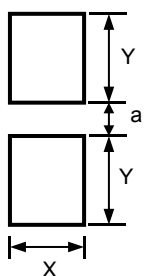

Size	X	Y	a
∅4	1.6	2.6	1.0
∅5	1.6	3.0	1.4
∅6.3	1.6	3.5	2.1
∅8×10.5L	2.5	3.5	3.0
∅10×10.5L	2.5	4.0	4.0
∅12.5×13.5/16	3.0	5.7	4.0
∅16×16.5	3.5	6.5	6.0

20. Explanation of Part Number

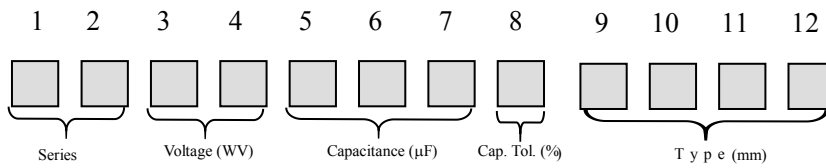

Example:

HT 2A 1R0 M 0405

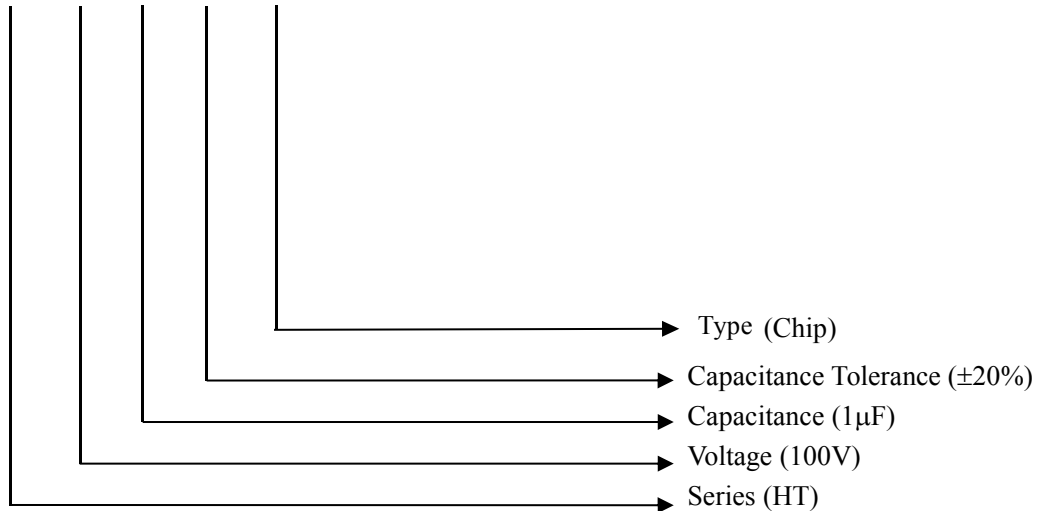

21. Construction

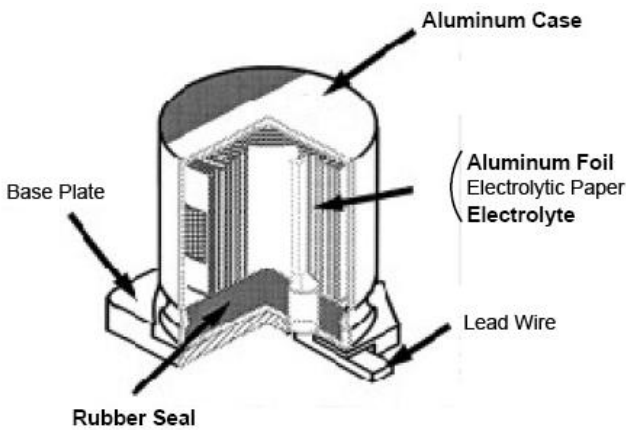

22. Frequency Coefficient of Allowable Ripple Current

Frequency		50Hz	120Hz	300Hz	1KHz	10KHz~	
Coefficient t	Ø4 ~ Ø10	0.1 ~ 68μF	0.70	1.00	1.17	1.36	1.50
		100 ~ 3300μF	0.85	1.00	1.08	1.20	1.30
	Ø12.5 ~ Ø16	~ 68μF	0.75	1.00	1.35	1.57	2.00
		100 ~ 680μF	0.80	1.00	1.23	1.34	1.50
		1000 ~ 6800μF	0.85	1.00	1.10	1.13	1.15

23. Dimensions & Maximum Permissible Ripple Current

Part Number	Customer P/N	Capacitance (μF)	Working Voltage (V)	Case Size ØD×L (mm)	Ripple current (Ma rms) at 105°C, 120Hz
HT2A010M0405	/	1	100	4X5.4	7

24. General Information for Application

The following precautions must be observed when using electrolytic capacitors.

A) Circuit Design

- 1) Please make sure that the environmental and mounting conditions to which the capacitor to be exposed are within the conditions specified in this catalogue.
- 2) Operating temperature and applied ripple must be within the specifications.
 - ① The capacitor shall not be used in an ambient temperature which exceeds the operating temperature specified in the specification.
 - ② Do not apply excessive current which exceeds the allowable ripple current.
- 3) Appropriate capacitors which comply with the life requirement of the products, should be selected when designing the circuit.
- 4) Aluminum electrolytic capacitors are polarized. Make sure that no reserve voltage or AC voltage is applied to the capacitors. Please use non-polarized capacitors for a circuit that can possibly see reserved polarity.
Note: Even non-polarizes capacitors cannot be used for AC voltage application.
- 5) For a circuit that repeats rapid charging/discharging of electricity, an appropriate capacitor that is capable of enduring such a condition must be used. Welding machines and photo flash are a few examples of products that contain such a circuit.

For appropriate choice of capacitors for circuit that repeat rapid charging/discharging, please consult us.

- 6) Make sure that no excess voltage (that is higher than the rated voltage) is applied to the capacitor.
 - ① Pleas pay attention so that the peak voltage, which is DC voltage overlapped by ripple current, should not exceed the rated voltage.
 - ② In the case where more than two aluminum electrolytic capacitors are used in series, please make sure that applied voltage should be lower than rated voltage should be applied to each capacitor equally using a balancing resistor in parallel with the capacitor.
- 7) Outer sleeved of the capacitor is not guarantee as an electrical insulator. Do not use standard sleeve on a capacitor in applications that require electrical insulation. When the application requires special insulation, please contact our sales office for details.
- 8) Capacitors may fail if they are used under the following conditions:
 - ① Environmental (climatic) conditions
 - (a) Being exposed to water, high temperature & high humidity atmosphere, or condensation of moisture.
 - (b) Being exposed to oil or an atmosphere that is filled with particles of oil.
 - (c) Being exposed to salty water or an atmosphere that is filled with particles of salt.
 - (d) In an atmosphere filled with toxic gasses (such as hydrogen sulfide, sulfurous acid, nitrous acid, chlorine, bromine, methyl bromide, ammonia, etc.).
 - (e) Being exposed to direct sunlight, ozone, ultraviolet ray, or radication.
 - (f) Being exposed to acidic or alkaline solutions.
 - ② Severe vibration and physical shock conditions that exceed our specification.

Vibration test condition:

- Vibration frequency range: 10~55~10Hz
- Sweet rate : 10~55~10Hz per minute
- Sweet method : logarithmic
- Amplitude or acceleration : 1.5mm (maximum acceleration is 10G)
- Direction of vibration : X, Y, Z direction
- Testing time : 2 hours per each direction

Shock is not applicable normally.

If a particular condition is required, please contact our sales office.

- 9) When designing a circuit board, please pay attention to the following:
 - ① Have the hole spacing on the P.C. board match the lead spacing of the capacitor.
 - ② There should not be any circuit pattern or circuit wire above the capacitor safety vent.
 - ③ Unless otherwise specified, following clearance should be made above the pressure relief vent.

Case Diameter	Clearance Required
---------------	--------------------

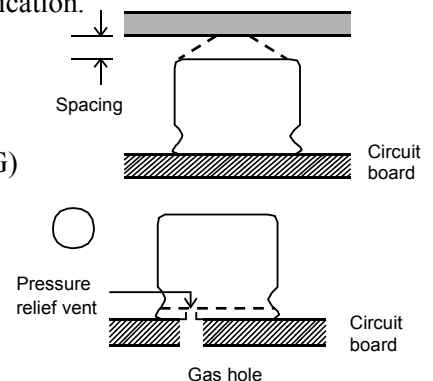

Ø6.3 to 16	2mm or more
Ø18 to 35	3mm or more
Ø40 or more	5mm or more

④ In case the vent side is placed toward P.C. board (such as end seal vented parts), make a corresponding hole on the P.C. board to release the gas when vent is operated. The hole should be made to match the capacitor vent position.

- 10) The main chemical solution of the electrolyte and the separator paper in the capacitor are combustible. The electrolyte is conductive. When it comes in contact with the P.C. board, there is a possibility of pattern or short circuit between the circuit pattern, which could result in smoking or fire. Do not locate any circuit pattern beneath the capacitor end seal.
- 11) Do not design a circuit board so that heat generating components are placed near an aluminum electrolytic capacitor or reserve side of P.C. board (under the capacitor).
- 12) Please refer to the recommended land size in this catalogue when you design in surface mount capacitors.
- 13) Electrical characteristics may vary depending on changes in temperature and frequency. Please consider the variation when you design circuits.
- 14) When you install more than 2 capacitors in parallel, consider the balance of current following in to the capacitor.
- 15) While mounting capacitors on double side P.C. board, the capacitors should be away from those unnecessary base plate holes and connection holes.

B) Mounting

- 1) Once a capacitor has been assembled in the set and power applied, do not attempt to re-use the capacitor in other circuits or application.
- 2) Electric potential between positive and negative terminal may exist as a result of returned electromotive force, so please discharge the capacitor using 1KΩ resistor.
- 3) Leakage current of the parts that have stored for more than 2 years may increase. When leakage current has increased, please perform a voltage treatment using a 1KΩ resistor.
- 4) Please confirm rating and polarity before installing capacitor on the P.C. board.
- 5) Do not drop the capacitors on the floor, nor use a capacitors that was dropped.
- 6) Be careful not to deform the capacitor during installation.
- 7) Please confirm that the lead spacing of the capacitor matches the pad spacing of the P.C. board prior to installation.
- 8) Please pay attention that the clinch force is not too strong when capacitors are placed and fixed by an automatic insertion machine.
- 9) Please pay attention to the mechanical shock to the capacitor by suction nozzle of the automatic insertion machine or automatic mounted, or by product checker, or by centering mechanism.
- 10) Hand soldering:
 - ① Soldering condition shall be confirmed to be within the specification.
 - ② If it is necessary that the leads must be formed due to a mismatch of the lead space to hole space on the board, bend the lead prior to soldering without applying too much stress to the capacitor.
 - ③ If you need to remove parts which were soldered, please melt the solder enough so that stress is not applied to lead.
 - ④ Please pay attention so that solder iron does not touch any portion of capacitor body.
- 11) Flow soldering (wave solder):
 - ① Aluminum capacitor body must not be submerged into the solder bath.
 - ② Soldering condition must be confirmed to be within specification.
 - ③ Please avoid having flux adhere to any portion except the terminal.
 - ④ Please avoid contact between other components and the aluminum capacitor.
- 12) Reflow soldering (SMD only):
 - ① Please follow "Reflow Soldering Conditions" in this catalogue.
 - ② When an infrared heater is used, please pay attention to the extent of heating since the absorption rate of infrared, will vary due to difference in the color and size of the capacitor.
- 13) Do not tilt lay down or twist the capacitor body after the capacitor are soldered to the P.C. board.
- 14) Do not carry the P.C. board by grasping the soldered capacitor.
- 15) Please do not allow anytime to touch the capacitor after soldering. If P.C. board are stored in stack, please make sure P.C. board or the other components do not touch the capacitor. The capacitors shall not be effected by any radiated heat from the soldered P.C. board or other components after soldering.
- 16) Cleaning
 - ① Do not clean capacitors with halogenated cleaning agent. However, if it is necessary to clean with halogenated cleaning agent, please contact our sales office.

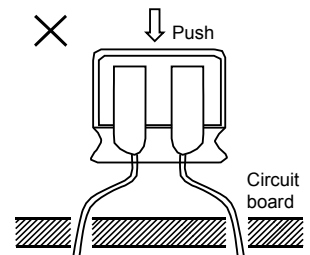

② Recommended cleaning method:

Applicable: Any type, any ratings.

Cleaning agents:

Based alcohol solvent cleaning agent: Isopropyl Alcohol

Based water solvent cleaning agent:

Premium alcohol solvent type: Pine Alpha ST-100S, Techno Care FRW14~17, Sanelek B-12

Surfactant type: cleaning through 750H/750L/710M

Alkaline saponification agent: Aqua Cleaner 210SEP

Cleaning conditions:

Total cleaning time shall be within 5 minutes by immersion, ultrasonic or other method. Temperature of the cleaning agent shall

be 60°C or lower. After cleaning, capacitors should be dried using hot air for minimum of 10 minutes along with the P.C. board. Hot air temperature should be below the maximum operating temperature of the capacitor. Insufficient dry after water rinse may cause appearance problems, sleeve shirk, bottom-plate bulge and such.

③ Avoid using ozone destructive substance for cleaning agents to concern about global environment.

17) Fixing Material and Coating Material

① Do not use any affixing or coating materials, which contain halide substance.

② Remove flux and any contamination, which remains in the gap between the end seal and P.C. board.

③ Please dry the cleaning agent on the P.C. board before using affixing or coating materials.

④ Please do not apply any material all around the end seal when using affixing or coating materials.

There are variations of cleaning agents, fixing and coating materials, so please contact those manufacture or our sales office to make sure that the material would not cause any problems.

18) Other

Wooden package material may be subjected to fumigation by a halogen (e.g. methyl bromide) before they are exported in order to protect them against pests. If devices with aluminum electrolytic capacitors or capacitors themselves are directly fumigated or packed with the pallet that is fumigated, the capacitors may internally corrode due to the halogen contents of fumigation agents.

C) In The Equipment

1) Do not directly touch terminal by hand.

2) Do not short between terminal by conductor, nor spill conductible liquid such as alkaline or acidic solution on or near the capacitor.

3) Please make sure that the ambient conditions where the set is installed not have any of the following conditions:

① Where capacitors are exposed to water, high temperature & high humidity atmosphere, or condensation of moisture.

② Where capacitors are exposed to oil or an atmosphere that is filled with particles of oil.

③ Where capacitors are exposed to salty water, high temperature & high humidity atmosphere, or condensation of moisture.

④ The atmosphere is filled with toxic acid gasses (e.g. hydrogen sulfide, sulfurous acid, nitrous acid, chlorine, bromine, methy bromide, etc.).

⑤ The atmosphere is filled with toxic alkaline gasses (e.g. ammonia).

⑥ Where capacitors are exposed to acidic or alkaline solutions.

⑦ Since shrinkage, bulging and/or crack could be seen on outer sleeve of capacitor when capacitors are used in atmosphere where condensation of moisture occurs, please confirm their adaptation before the use. The condensation of moisture could occur when temperature cycling test/rapid change of temperature test is performed, in this case, aforementioned sleeve problem could be seen.

D) Maintenance and Inspection

Please periodically inspect the aluminum capacitors that are installed in industrial equipment. The following items should be checked:

1) Appearance: Remarkable abnormality such as vent operation, leaking electrolyte etc.

2) Electrical characteristic: Capacitance, dielectric loss tangent, leakage current etc., which are specified in this catalogue.

E) In an Emergency

1) If you see smoke due to operation of safety vent, turn off the main switch or pull out the plug from the outlet.

2) Do not draw your face to the safety vent since gas over 100°C will be emitted when the safety vent operates. If the gas has entered your eyes, please flush your eyes immediately in pure water. If you breathed the gas

immediately wash out your mouth and throat with water.

- 3) Do not ingest electrolyte. If your skin is exposed to electrolyte, please wash it away using soap and water.

F) Storage

- 1) Do not keep capacitor in high temperature and high humidity.

Storage conditions should be:

Temperature : +5°C ~ +35°C

Humidity : Lower than 75%

Place : Indoor

- 2) Avoid ambient conditions where capacitors can be covered with water, brine or oil.
- 3) Avoid ambient conditions where capacitors are exposed to poisonous gases such as hydrogen sulfide, sulfurous acid, nitrous acid, chlorine, ammonium etc.
- 4) Do not keep capacitor in conditions that expose the capacitor to ozone, ultraviolet ray or radiation.
- 5) Store capacitors in a packed condition as much as possible.

G) Disposal

- 1) Please dispose capacitors in either of the following ways:

① Incinerate (at a temperature of 800°C or higher) capacitors after crushing parts or making a hole on the capacitor body.

② If incineration is not applicable, hand them over to a waste disposal agent and have them buried in a landfill.

- 2) When removing a capacitor from the circuit board or when disposing of capacitor please ensure that the capacitor is properly discharged.

25. Other

All design and specifications are for reference only and is subject to change without prior notice. If any doubt about safety for your application, please contact us immediately for technical assistance before purchase.

NO.	Prohibited Substances	content
1	Cd	N.D
2	Pb	<50PPM
3	Hg	N.D
4	CrVI	N.D
5	PBB	N.D
6	PBDE	N.D
7	DBP	N.D
8	BBP	N.D
9	DEHP	N.D
10	DIBP	N.D
11	SVHC	N.D